



11848
(4270581, 4334140,1,2,
5201359)

#12-28 x 2-1/2"
Headlight
Adjusting
Screw & Nut
Assembly
Torx Drive
Chrysler 1978-On

UNIT PACKAGE: 10

11849

Same as 11848 Except Packing
UNIT PACKAGE: 100

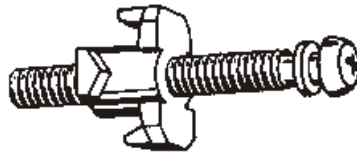

11371
(3691599)

#12-28 x 1-1/2"
Headlight
Adjusting Screw
& Nut Assembly
Chrysler 1975-On

UNIT PACKAGE: 10



16581
(152863)

Natural Nylon

Rear Window Garnish
Moulding Nut
#8 Screw Size
Chrysler 1978-On

UNIT PACKAGE: 50

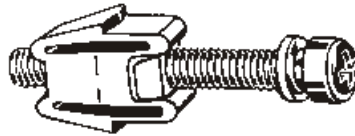

10760

#12-28 x 1-1/2"
Headlight
Adjusting Screw
& Nut Assembly
Chrysler 1972-On

UNIT PACKAGE: 10



8419

(2524525)
Natural Nylon

Headlight Bezel Nut
#8 or #10 Screw Size
Chrysler

UNIT PACKAGE: 50

Please Order In Unit
Package Quantities
Not Number Of Pieces

10761

Same as 10760 Except Packing
UNIT PACKAGE: 100



13466

(6032516)
Black Nylon

License Plate Nut
#12 Screw Size
Chrysler

UNIT PACKAGE: 25

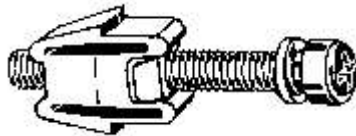

11653
(3574085)
Gray Nylon

#12-28 x 1-1/2"
Headlight
Adjusting Screw
& Nut Assembly
Chrysler 1976-On

UNIT PACKAGE: 25

11654

Same as 11653 Except Packing

UNIT PACKAGE: 100



16583
(2524526)
Black Nylon

Headlight
To Front Fender
Mounting Plate Nut
#8 or #10 Screw Size
Chrysler

UNIT PACKAGE: 25



14800

(6500725)
Black Nylon

Headlight Bezel Nut
#10 Screw Size
Chrysler 1983-On

UNIT PACKAGE: 50



9377
 (Chry: 6000943;
 AMC: 8934-201-263)
 White Nylon

Radiator Grille Nut
 #8 Screw Size
 Chrysler & AMC-Renault

UNIT PACKAGE: 100



14756
 (Chry: 6033677;
 Ford: 379830-S)
 Black Nylon

3/8" Wide, 3/8" Long
 Fits Into 9/32" x 9/32" Hole
 Panel Thickness: 1/4"
 #8 Screw Size
 Chrysler & Ford 1986-On

UNIT PACKAGE: 25



20179
 (6035401)
 Green Nylon

Door Trim Panel
 Nylon Nut
 M4.2 (#8) Screw Size
 Head Size: 16mm x 16mm
 Stem Length: 10mm
 Caravan, Town & Country
 and Voyager
 1996 - On

UNIT PACKAGE: 25



12735
 (GM: 1370853;
 Chry: 6029501;
 VW: 179-813-883)
 Natural Nylon

Headlight Bezel Nut
 #6 Screw Size
 GM & VW 1982-On

UNIT PACKAGE: 50



19785
 (4805119)
 Natural Nylon

Cowl Vent Nylon Nut
 #10 (M4.8) Screw Size
 LH, Neon & 300M
 1998 - On

UNIT PACKAGE: 25



20267
 (6505703AA)
 Tan Nylon

Tail Light
 Nylon Nut
 Head Size: 5/8" x 5/8"
 Stem Length: 3/8"
 #8 (M4.2) Screw Size
 Jeep Grand Cherokee
 2000 - On

UNIT PACKAGE: 15



19485
 (6027958)
 Natural Nylon

License Plate Nut
 & Door Lock
 Remote Control
 Switch Bracket Nut
 #14 (1/4") Screw Size
 Fits Into 3/8" x 3/8" Hole
 Chrysler 1984-On

UNIT PACKAGE: 10



20894
 (6507009-AA)
 White Nylon

Door & Interior Trim Panel
 Screw Grommet With Sealer
 M4.2 (#8) Screw Size
 Head Size: 15mm x 15mm
 Stem Length: 20mm
 Dodge Durango, Jeep Liberty
 & Grand Cherokee
 2002 - On

UNIT PACKAGE: 25



14218
 (6031183)
 Black Nylon

#6 or #8 Screw Size
 Chrysler

UNIT PACKAGE: 50



12569
 (Ford: N801706-S;
 Chry: 6501773)
 Black Nylon

#12 Screw Size

UNIT PACKAGE: 25



19640
 (6505161AA)
 White Nylon

Bumper Fascia Grommet
 Screw Size: M4.2 (#8)
 Head Dia.: 14mm x 18mm
 Snaps Into a 9mm x 11mm Hole
 LH & LHS Series
 1998-On

UNIT PACKAGE: 25



11720
 White Nylon

Grille Nut
 #8 or #10 Screw Size
 Chrysler 1976-On

UNIT PACKAGE: 50



18034
 (6503108)
 Black Nylon w/Cushion

Luggage Compartment Trim
 Nylon Nut
 #8 Screw Size
 Chrysler Concorde & LHS,
 Dodge Intrepid & Eagle Vision
 1993-On

UNIT PACKAGE: 25



13647
 (6031234)
 White Nylon

Radiator Grille Nut
 #8 Screw Size
 Chrysler

UNIT PACKAGE: 25



19793
 (6504072)
 Black Nylon

Tail Light Housing Grommet
 Head Diameter: 16mm
 Stem Length: 10mm
 Snaps Into 12mm Hole
 Dakota & Ram Trucks
 1997 - On

UNIT PACKAGE: 25



12566
(Chry: 6032061;
GM: 25508532)
Black Nylon

Grille
Attachment Grommet
Chrysler & GM 1981-On

UNIT PACKAGE: 25



20524
(6035821)
Black Nylon

Door Panel & Fender Shield
Screw Grommet
#8 Screw Size
Head Size: 1/2" x 21/32"
Stem Length: 7/16"
Dodge Vans, Durango & Sebring
1996 - On

UNIT PACKAGE: 25



19642
(4805336AA)
White Nylon

Bumper Fascia Grommet
Head Dia.: 10mm x 15mm
Snaps Into 9mm x 12mm Hole
Concorde, Intrepid
& Eagle
1998-On

UNIT PACKAGE: 25



12713
(Chry: 6031869;
GM: 1264963;
AMC: 8934-201-602)
Natural Nylon

High Torque Screw Grommet
Chrysler, GM & AMC-Renault

UNIT PACKAGE: 25



17354
(6501699)
Black Nylon

Cowl Screen Nut
#8 Screw Size
Chrysler Mini-Vans & Cars
1990-On

UNIT PACKAGE: 25



21025
(MB645307)
Black Nylon

Back Glass Lower Moulding,
Quarter Glass Moulding &
Spoiler Grommet With Sealer
Head Size: 12mm x 16mm
Stem Length: 14mm
Dodge Avenger & Stealth and
Chrysler Sebring
1991 - On
Mitsubishi
1991 - On

UNIT PACKAGE: 15



19276
(34201872,
8934-201-872)
Natural Nylon

Door Trim Panel
& Cowl Grille Seal
Screw Grommet
#4 or #6 Screw Size
Jeep Cherokee, Grand Cherokee,
Comanche & Grand Wagoneer
1991-On

UNIT PACKAGE: 25



18825
(6503373)
Black Nylon

Cowl & Dash Panel
Screw Grommet
#8 Screw Size
Cirrus & Stratus
1995-On

UNIT PACKAGE: 15



20769
(4857751AA)
Natural Nylon

Tail Light Grommet
Head Size: 17mm x 19mm
Overall Length: 21.5mm
Chrysler Pacifica
2004 - On

UNIT PACKAGE: 25



14037
(GM: 15596280;
Chry: 6035274)
Black Nylon

Cowl Vent Nut
#6 or #8 Screw Size

UNIT PACKAGE: 25



20275
Not Supplied
By O.E.M.
White Nylon

Door Panel Grommet
Head Dia: 19mm
Stem Length: 12mm
Fits Into 9mm Hole
Use With Auveco 20274
LH Series
2000 - On

UNIT PACKAGE; 25



20525
Not Available
From O.E.M.
Black Nylon

Headlight Mounting
Panel Grommet
Head Size: 16mm x 22mm
Stem Length: 20mm
Jeep Grand Cherokee
1999 - On

UNIT PACKAGE: 25



20667
(4860375-AB)
White Nylon

Cowl Vent Grommet
M4.8 (#10) Screw Size
Head Size: 14mm x 20mm
Caravan, Town & Country
And Voyager Mini-Vans
2004 - On

UNIT PACKAGE: 50



20468
(6506852-AA)
Green Nylon

Trim Panel Grommet
Head Dia.: 17mm
Stem Length: 12mm
Fits Into 8mm Hole
Use with Auveco 20467
Sebring & Stratus 2001 - On

UNIT PACKAGE: 50

For The Most
Up-To-Date
Information On New
Items Available From
Auveco, refer to the
"Hot New Items"
Section of the Auveco
Web Site
(www.auveco.com)



20356
(4759514AB)
Black Rubber

Rubber Grommet
Head Diameter: 15mm
Stem Length: 11mm
Fits Into 9mm Hole
Floor Pan Plug &
Luggage Compartment Carpet
LH, LHS & Concorde
1997 - On

UNIT PACKAGE: 50



20581
(MR478263)
Black Rubber

Bumper Cover &
Garnish Moulding Grommet
With Sealer
Head Diameter: 16mm
Stem Length: 20mm
Fits Into 9mm Hole
Use With Auveco 20580
Sebring & Stratus
And Mitsubishi Eclipse
2000 - On

UNIT PACKAGE: 15



20962
(55156879-AB)
Black Nylon

Tail Light Grommet
Head Size: 20mm x 31mm
Receives 10mm Ball Stud
Jeep Commander
2006 - On

UNIT PACKAGE: 25



19809
(6504870AA)
Natural Nylon

Nylon "U" Nut
M4.2 (#8) Screw Size
Panel Range: 1mm - 4.25mm
Center Of Hole To Edge: 10mm
LH & 300M
1998 - On

UNIT PACKAGE: 25



20964
(5159077-AA)
Black Nylon

Rear Bumper Clip
Stem Length: 15/32"
Overall Length: 31/32"
Jeep Grand Cherokee
2005 - On

UNIT PACKAGE: 25



17195
(Isuzu: 8942180270)
Black Nylon

Grille Clip
13mm Wide
22mm Long
Ford Escort, Honda, Isuzu,
Mitsubishi & Plymouth Laser

UNIT PACKAGE: 25



13843
(6003861)
Nylon

Deck Lid
Moulding Clip
Chrysler 1984-On

UNIT PACKAGE: 25



12794
(6003609)
Nylon

Roof Side Moulding Clip
Chrysler 1977-On

UNIT PACKAGE: 50

Please Order
In Unit Package
Quantity
Not Pieces

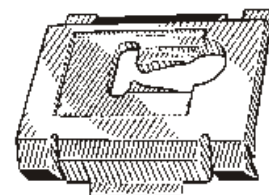

13927
(6003774,
6003965)
Nylon

Body Side Moulding Clip
Chrysler 1981-On

UNIT PACKAGE: 25



13616
(6003219)
Nylon

Moulding Clip
Chrysler 1971-On

UNIT PACKAGE: 25

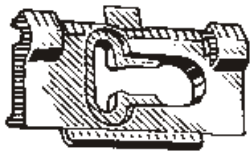

13847
(6003858)
Nylon

Deck Lid Moulding Clip
Chrysler Vans 1984-On

UNIT PACKAGE: 25

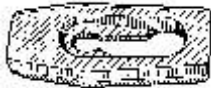

12913
(6003647)
Nylon

Quarter Outside Belt
Moulding Clip
Chrysler 1977-On

UNIT PACKAGE: 25

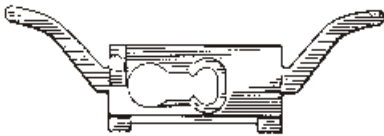

11936
(6003632)
Nylon

Wheel Opening Moulding Clip
Chrysler 1978-On

UNIT PACKAGE: 50

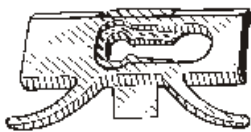

13615
(6003575)
Nylon

Wheel Opening
Moulding Clip
Chrysler
1975-On

UNIT PACKAGE: 25



11354
(6003147)
Nylon

Moulding Clip
Chrysler 1976-On

UNIT PACKAGE: 25

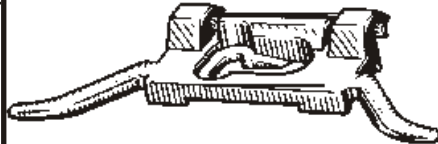

17064
(6004162)
Nylon

Woodgrain Side
Moulding Clip
Dodge Caravan &
Plymouth Voyager
Mini-Vans 1990-On

UNIT PACKAGE: 25

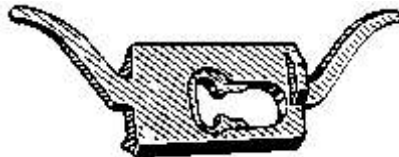

13845
(6003873)
Nylon

Body Side & Back Door
Moulding Clip
Chrysler Vans 1984-On

UNIT PACKAGE: 50



17151
(6004036)
Nylon

Window Reveal Moulding Clip
Chrysler LeBaron & Maserati
1987-On

UNIT PACKAGE: 15



19894
(5FR56DX9)
Black Nylon

Rocker Panel Clip
Head Size: 7/16" x 25/32"
Stem Length: 5/8"
Jeep Grand Cherokee
1999 - On

UNIT PACKAGE: 25



20523
(55156429-AA)
Black Nylon

Rocker Panel &
Bumper Fascia Clip
Top Head Size:
1/2" x 1-3/16"
Stem Length: 27/32"
Jeep Liberty
2002 - On

UNIT PACKAGE: 10



20828
(55157070-AC)
Black Nylon

Rocker Moulding Clip
Head Diameter: 25mm
Overall Length: 31mm
Fits Into 8mm Hole
Jeep Liberty
2002 - On

UNIT PACKAGE: 10

Auveco
Display Boards
Are Great
Selling Tools.
Use Them To Help
Boost Your Sales.
Refer To The
Color Pages
At The Front Of The
Catalog.



20763
(1BA41AX1-AA)
Black Nylon

Rocker Panel Moulding Clip
Head Size: 12mm x 20mm
Stem Length: 13mm
Chrysler 300 & Dodge Magnum
2005 - On

UNIT PACKAGE: 15



21099
Not Available From O.E.M.
White Nylon

Lift Gate Moulding Clip
With Sealer
Top Head Size: 12mm x 21mm
Bottom Head Size: 16mm x 18mm
Stem Length: 11mm
Magnum 2006 - On

UNIT PACKAGE: 10



20887
(55157055-AA,
55157065-AA)
Gray Nylon

Fender Flare Moulding Clip
Top Head Size: 14mm x 38mm
Bottom Head Size: 16mm x 38mm
Stem Length: 15mm
Fits Into 9mm Hole
Jeep Liberty
2005 - On

UNIT PACKAGE: 15



20870
Not Available From O.E.M.
White Nylon

Rocker Panel Moulding Clip
Top Head Size: 9/16" x 13/16"
Bottom Head Size: 9/16" x 23/32"
Stem Length: 5/8"
Dodge Dakota & Durango
And Jeep Liberty
2000 - On

UNIT PACKAGE: 15



20827
(55157069-AB)
White Nylon

Rocker Moulding Clip
Top Head Size: 14mm x 27mm
Bottom Head Size: 13mm x 26mm
Stem Length: 15mm
Fits Into 9mm Hole
Jeep Liberty
2002 - ON

UNIT PACKAGE: 25



20771
(4857699-AA)
Black Nylon

Front Bumper Fascia To Grille Retainer
Head Size: 10mm x 42mm
Stem Length: 14mm
Fits Into 7.5mm Hole
Chrysler Pacifica
2004 - On

UNIT PACKAGE: 25



20982
Not Available From O.E.M.
White Nylon

Fender & Wheel Flare Moulding Clip
Top Head Size: 14mm x 18mm
Bottom Head Size: 17mm x 21mm
Stem Length: 13mm
Fits Into 9mm Hole
Jeep Commander
2006 - On

UNIT PACKAGE: 25



20700
(55156447-AB)
Black Nylon

Ground Effects Moulding Clip
Head Width: 1/2"
Head Length: 1-1/2"
Stem Length: 1/2"
Jeep Liberty
2004 - On

UNIT PACKAGE: 25

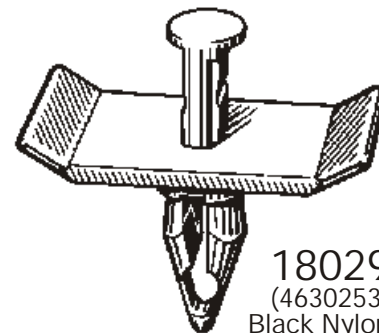

18029
(4630253)
Black Nylon

Rear Fascia Push-Type Retainer
Head Size: 7/8" x 1-25/32"
Stem Length: 1-1/16"
Fits Into 1/2" Hole
Chrysler Concorde & LHS
Dodge Intrepid & Eagle Vision
1993-On

UNIT PACKAGE: 15



19131
Not Available
From O.E.M.
Black Nylon

Cowl Screen Retainer
Chrysler New Yorker, Intrepid,
LHS, Concorde & Eagle Vision
1993-On

UNIT PACKAGE: 15



18032
(6502573)
Black Nylon

Cowl Screen
Attachment
Push-Type Retainer
Head Size: 15/32"
Stem Length: 9/16"
Fits Into 1/4" Square Hole
Chrysler Concorde & LHS,
Dodge Intrepid & Eagle Vision
1993-On

UNIT PACKAGE: 15



17214
(GM:10089262,
21042098;
Chry: 55075139)
Black Nylon

Push-Type Retainer
Head Dia: 11mm (7/16")
Stem Length: 18mm (11/16")
Fits Into 6mm (15/64") Hole
GM Saturn
4 Door & Station Wagon
1991 - On

UNIT PACKAGE: 25

14987

Same As 17214 Except Packing

UNIT PACKAGE: 50



14995
(GM: 10195515;
Ford: N805026S;
Chrys: 4696488, 6503163)
Black Nylon

Push-Type Retainer
Head Diameter: 1/2"
Stem Length: 1-13/64"
Fits Into 9/32" Hole
Ford, GM & Chrysler
1987 - On

UNIT PACKAGE: 25



14992
(Ford: N803946S;
Chrys: 6502871)
Black Nylon

Push-Type Retainer
Head Diameter: 19/32"
Stem Length: 29/32"
Fits Into 1/4" Hole
Ford & Chrysler 1987 - On

UNIT PACKAGE: 50



15672
(8880417)
Black Nylon

Push-Type Retainer
Head Diameter: 17mm
Stem Length: 14mm
Fits Into 8mm (5/16") Hole
Chrysler 1987-On

UNIT PACKAGE: 25



14753
(Chry: 4638136;
GM: 20664092;
Ford: N804570S)
Black Nylon

Radiator Shroud &
Trim Retainer
Push-Type Retainer
Head Dia: 11/16"
Stem Length: 7/8"
Fits Into 1/4" Hole
Chrysler 1998 - On
GM 1982 - On
Ford 1986 - On

UNIT PACKAGE: 25



21098
(Chrysler: 6508197-AA;
Ford: W706092-S300)
Black Nylon

Front Air Shield,
Splash Guard &
Heat Shield
Push-Type Retainer
Head Diameter: 18mm
Stem Length: 18mm
Fits Into 6.4mm Hole
Dodge Ram 2006 - On
Ford Taurus 2008 - On

UNIT PACKAGE: 25



19140
(Acura:
90505-SLO-003;
GM: 94852368;
Mitsubishi:
MB888869; Toyota:
90467-08155)
Black Nylon

Push-Type Retainer
Head Diameter: 20mm
Stem Length: 21mm
Fits Into 8mm Hole
Acura, Dodge Avenger,
Eagle Talon, Geo Prizm,
Mitsubishi Eclipse & Galant
and Toyota
1993-On

UNIT PACKAGE: 5

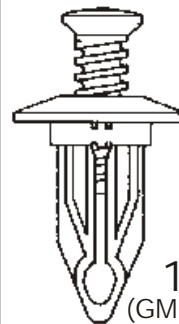

16835
(GM: 10140480;
Chry: 6502625)
Black Nylon

Push-Type Retainer
Head Dia: 21mm (27/32")
Shoulder Length: 3mm (1/8")
Stem Length: 25mm (1")
Fits Into 12mm (1/2") Hole

UNIT PACKAGE: 25



17104
(6501630,6501772,
6501878)
Black Nylon

Headlight & Tail Light
Panel Attachment
Push-Type Retainer
Head Size: 15mm x 31mm
Stem Length: 17mm
Fits Into 5mm x 6.5mm Hole
Dodge Daytona 1987-On

UNIT PACKAGE: 10



11704
(6031383)
Black Nylon

Grille Retainer
Head Diameter: 11/16"
Stem Length: 7/16"
Fits Into 9/32" Hole
Chrysler 1978-On

UNIT PACKAGE: 25



11699
(GM: 472434;
Chry: 6031390)
Black Nylon

Cowl Ledge
Weatherstrip & Fender Liner
Push-Type Retainer
Head Dia: 11/16"
Stem Length: 5/8"
Fits Into 1/4" Hole
GM 1970-On
Chrysler 1968-On

UNIT PACKAGE: 50



20273
(Ford: N808791;
Chrys: 5GC71RC3AA,
5GF92RC3AA)
Gray Nylon

Interior Trim, Dash & Console
Push-Type Retainer
Head Dia: 19mm
Shoulder Dia: 10mm
Shoulder Length: 7mm
Stem Length: 22mm
Fits Into 9mm Hole
Dodge Durango &
Ford Pick-Ups
1997 - On

UNIT PACKAGE: 25



20739
(WX68DX9-AA)
Black Nylon

Door Trim Panel
Push-Type Retainer
Head Diameter: 22mm
Stem Length: 10mm
Fits Into 9mm Hole
Chrysler 300 & Dodge Magnum
2005

UNIT PACKAGE: 25



21021
(OWX68BD5-AA)
Gray Nylon

Door Trim Panel
Push-Type Retainer
Head Diameter: 22mm
Stem Length: 10mm
Fits Into 9mm Hole
Charger,
Magnum & 300M
2005 - On

UNIT PACKAGE: 25



20948
(OWX68BD1-AA)
Tan Nylon

Door Trim Panel
Push-Type Retainer
Head Diameter: 22mm
Stem Length: 10mm
Fits Into 9mm Hole
Chrysler 300M and Dodge
Charger & Magnum
2005 - On

UNIT PACKAGE: 25

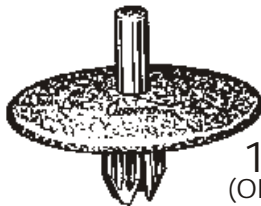

17080
(OH452KD5)
Nylon
Quartz
Matte Finish

Headliner Retainer
Head Dia: 1-1/4"
Stem Length: 7/16"
Fits Into 1/4" Hole
Dodge Caravan &
Plymouth Voyager 1984-On

UNIT PACKAGE: 15

For the most up-to-date
information on new items
available from Auveco,
refer to the "Hot New
Items" section of the
Auveco web site
(www.auveco.com)



12567
(GM: 14019205,
14019206, 16514113;
Chry: 34201621, 6504090)
Black Nylon

Front Fender Mud Skirt
& Fender Liner
Push-Type Retainer
Head Dia: 11/16"
Stem Length: 9/16"
Fits Into 1/4" Hole
GM 1981 - On
Chrysler

UNIT PACKAGE: 25

14007

Same as 12567 except packing

UNIT PACKAGE: 50



18327
(6503454)
Black Nylon

Front Bumper Fascia
Push-Type Retainer
Head Diameter: 11/16"
Stem Length: 5/8"
Fits Into 1/4" Hole
Jeep Grand Cherokee
1994-On

UNIT PACKAGE: 25



14016
(GM: 16500308;
Chry: 6500787)
Black Nylon

Tail Light Retainer
Large Head Diameter: 3/8"
Stem Length: 7/16"
Fits Into 3/16" Hole
GM & Chrysler

UNIT PACKAGE: 25



20580
(MR478262)
Black Nylon

Bumper Cover &
Garnish Moulding
Push-Type Retainer
Top Head Diameter: 15mm
Bottom Head Diameter: 14mm
Stem Length: 12mm
Fits Into 7mm Hole
Use With Auveco 20581
Sebring & Stratus
And Mitsubishi Eclipse
2000 - On

UNIT PACKAGE: 15



19639
(GM: 15149708;
Chrys: 6506008AA)
Black Nylon

Radiator, Wheelhouse,
Fender & Front Bumper Cover
Push-Type Retainer
Head Diameter: 17mm
Stem Length: 16mm
Fits Into 6mm Hole
GM C & K Trucks 1999 - On
Jeep Liberty 2002 - On

UNIT PACKAGE: 25



20988
(GM: 11589289;
Chrysler: 6508863-AA)
Black Nylon

Air Distributor &
Windshield Defroster
Push-Type Retainer
Head Diameter: 18mm
Stem Length: 17.5mm
Panel Range: 2.0mm - 4.5mm
Fits Into 6.5mm Hole
GM 2002 - On
Chrysler

UNIT PACKAGE: 25

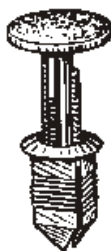

14961
(4248294,
F155EK1)
Tan Nylon

Interior Trim
Push-Type Retainer
Large Head Diameter: 13mm
Stem Length: 7mm (Exc. the pin)
Fits Into 7mm Square Hole
Chrysler 1987 - On

UNIT PACKAGE: 25



18030
(Chry: 6501925;
GM: 10134407)
Black Nylon

Push-Type Retainer
Head Size: 11/16"
Stem Length: 13/16"
Fits Into 1/4" Hole
Chrysler Concorde & LHS
Dodge Intrepid & Eagle Vision
1993-On
Coolant Recovery Reservoir
GM 1992-On

UNIT PACKAGE: 25



20966
(5160260-AA)
Black Nylon

Rear Bumper, Tail Light
And Fender
Push-Type Retainer
Bottom Head Diameter: 18mm
Stem Length: 20mm
Fits Into 8mm Hole
Dodge Caliber and
Jeep Compass & Patriot
2007 - On

UNIT PACKAGE: 15

14963
(4248294,
F155DT3)

Light Palomino Nylon

Same as 14961 except color

UNIT PACKAGE: 25

14965
(4248294,
F155GL7)

Taupe (Brownish-Gray)

Same as 14961 except color

UNIT PACKAGE: 25



13993
(GM: 20510029;
Ford: N803362-S;
Chry: 34202672)
Black Nylon

Body Retainer
Head Dia: 11/16"
Stem Length: 7/8"
Fits Into 1/4" Hole
GM 1984-On
Ford 1984 - On

UNIT PACKAGE: 25



20888
(GM: 11561368;
Chrys: 6508712AA)
Black Nylon

Fender, Wheel & Bumper
Push-Type Retainer
Head Diameter: 18mm
Stem Length: 20mm
Panel Range: 3.0mm - 5.8mm
Fits Into 9.5mm Hole
GM 2004 - On
Jeep Wrangler
2000 - On

UNIT PACKAGE: 25

14966
(4248294,
F155GR8)
Burgundy

Same as 14961 except color

UNIT PACKAGE: 25



19422
(6504521)
Black Nylon

Fascia
Push-Type Retainer
Large Head Dia.: 23/32"
Stem Length: 29/32"
Fits Into 5/16" Hole
LHS, Concorde,
Intrepid & Eagle Vision
1998-On

UNIT PACKAGE: 25



19245
(5BB14LX9)
Black Nylon

Fascia To Front Bumper
Push-Type Retainer
Large Head Dia.: 3/4"
Stem Length: 1-1/8"
Fits Into 1/4" Hole
Dodge Dakota
1994-On

UNIT PACKAGE: 25



17216
(GM: 21030249;
Ford: N807389S;
Chry: 6503598)
Black Nylon

Air Baffle To
Under Carriage
Push-Type Retainer
Head Diameter: 20mm
Stem Length: 20mm
Fits Into 8mm Hole

UNIT PACKAGE: 25



20768
(4806240AA)
Black Nylon

Rear Bumper
Push-Type Retainer
Large Head
Diameter: 18.5mm
Stem Length: 21mm
Fits Into 8mm Hole
Chrysler 300 & Dodge
Magnum
2005 - ON

UNIT PACKAGE: 10



20766
(6507669-AA)
Black Nylon

Radiator Grille
Push-Type Retainer
Head Diameter: 20mm
Stem Length: 16mm
Fits Into 10mm Hole
Dodge Durango
2004 - On

UNIT PACKAGE: 25



20457
(4857345-AA)
Black Nylon

Tail Light Housing
Push-Type Retainer
Large Head
Dia.: 21mm
Stem Length: 23mm
Fits Into 9.5mm Hole
Caravan
Town & Country And
Voyager Mini Vans
2002 - On

UNIT PACKAGE: 25



20990
(GM: 15296830;
Chrysler: 5116530-AA)
Black Nylon

Fascia & General
Purpose
Push-Type Retainer
Head Diameter: 19mm
Stem Length: 16mm
Panel Range: 5.0mm - 7.0mm
Fits Into 8mm Hole
GM 2007 - On
Chrysler

UNIT PACKAGE: 25



20458
(6506132-AA)
Black Nylon

Side Radiator Shield
Push-Type Retainer
Head Dia.: 20mm
Stem Length: 17mm
Fits Into 7mm Hole
Sebring & Stratus
2001 - On

UNIT PACKAGE: 25



20967
Not Available From O.E.M.
Black Nylon

Rear Bumper
Mounting Bracket
Push-Type Retainer
Head Diameter: 22mm
Stem Length: 16mm
Fits Into 10mm Hole
Jeep Commander
2006 - On

UNIT PACKAGE: 15

You Can E-Mail Your
New Item
Suggestions to
mail@auveco.com



18269
(6503106)
Black Nylon
Lower Sill Moulding
Push-Type Retainer
Large Head Dia.: 7/8"
Stem Length: 1"
Fits Into 1/4" Hole
Jeep Grand Cherokee
Laredo 1994-On
UNIT PACKAGE: 15



18394
(6503453)
Black Nylon
Fascia To Bumper
Push-Type Retainer
Large Head Dia.: 1"
Stem Length: 1-1/8"
Fits Into 1/4" Hole
Jeep Grand Cherokee
1994 - On
UNIT PACKAGE: 25



19638
(Chrys: 4805405AA;
Ford: 1L5Z-17K826AA)
Black & White Nylon
Front Bumper Fascia
Push-Type Retainer
Head Dia.: 34mm
Stem Length: 20mm
Fits Into 8mm Hole
Concorde, Intrepid, Eagle
Pacifica & PT Cruiser
1998-On
Ford Trucks
2005-On
UNIT PACKAGE: 15



20767
(4806110-AA)
Black & White Nylon
Front Bumper
Push-Type Retainer
Head Diameter: 24mm
Shoulder Length: 3mm
Stem Length: 20mm
Fits Into 11mm Hole
Chrysler 300 & Dodge Magnum
2005 - On
UNIT PACKAGE: 15



20940
(55157330-AC)
Black Nylon
Tail Light
Push-Type Retainer
Large Head
Diameter: 31mm
Small Head
Diameter: 20mm
Stem Length: 21mm
Fits Into 8mm
Square Hole
Jeep Commander
2006 - On
UNIT PACKAGE: 15



20890
(55157112-AA, -AB)
Black & Natural Nylon
Bumper Cover
Push-Type Retainer
Head Size: 25mm x 45mm
Shoulder Length: 3mm
Stem Length: 20mm
Fits Into 9.5mm Hole
Jeep Liberty
2005 - On
UNIT PACKAGE: 15

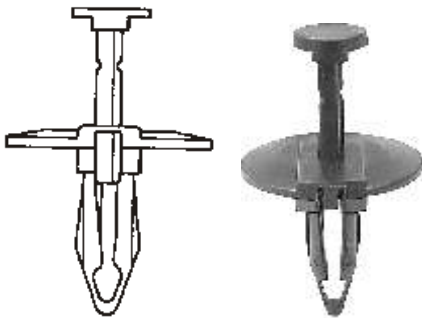

14019
(Ford: N803421-S;
Chry: 6501590)
Black Nylon
Push-Type Retainer
Head Dia: 1"
Shoulder Length: 1/8"
Stem Length: 7/8"
Fits Into 5/16" Hole
UNIT PACKAGE: 25



20963
(4806334-AA)
Black & White Nylon
Rear Bumper
Push-Type Retainer
With Sealer
Head Diameter: 34mm
Shoulder Length: 3.5mm
Stem Length: 17mm
Fits Into 8.5mm Hole
Dodge Caliber and
Jeep Compass & Patriot
2007 - On
UNIT PACKAGE: 10



19417
(Chrys: 6503819, 6503401;
GM: 25631448)
Black Nylon
M7.5 x 35mm
Square Drive Truss Head
22mm Head Diameter
9mm Shoulder Diameter
Foam To Bumper Fascia
Chrysler
1993 - On
GM 1997 - On
UNIT PACKAGE: 15



20970
Not Available
From O.E.M.
Black Nylon

M14 x 34mm
Bumper and Door Insulator
Nylon Screw
22mm Head O.D.
No. 3 Square Drive
Fits Into 12mm Hole
GM, Ford & Chrysler
2005 - On

UNIT PACKAGE: 25

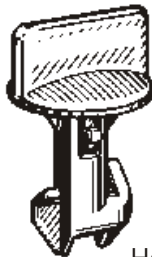

18237
(6502545)
Nylon

Headlight Side
Shield Retainer
Dodge Daytona
1992-On

UNIT PACKAGE: 25

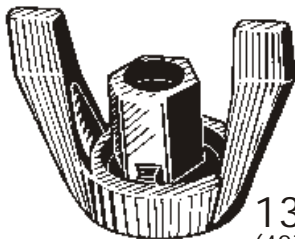

13465
(4275973)
Nylon

Air Cleaner
Wing Nut
1/4"-20
Chrysler

UNIT PACKAGE: 10

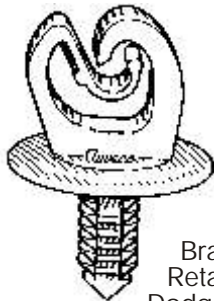

18267
(32000404)
White Nylon

Brake Line
Retainer Clip
Dodge Van With
Anti-Lock Brakes
1994-On

UNIT PACKAGE: 10



14985
(2664040)
White Nylon

Door Weatherstrip to
Inside Panel Clip
Chrysler Corp. 1966-On

UNIT PACKAGE: 100



18249
(6503339)
Black Nylon

Cowl Top Stud Retainer Cover
Head Diameter: 13/16"
Dodge Ram 1994-On

UNIT PACKAGE: 25



20623
(Chrysler:
6506306-AA)
Black Nylon

Cowl Screen Retainer
Head Diameter: 25mm
T-30 Torx® Drive
Stem Length: 14mm
Fits On To 1/4" - 20 Bolt
Dodge Dakota
1997 - On

UNIT PACKAGE: 15



20420
(6505863-AA)
Black Nylon

Wire Routing Clip
Holds 3/16" (5mm) Diameter Wire
Stem Diameter: 5/16"
Stem Length: 9/32"
Flange Diameter: 25/32"
Mini-Vans
2002 - On

UNIT PACKAGE: 15



14858
(3799089)

Windshield Wiper Linkage Bushing
Replaces worn wiper
linkage bushing
thus eliminating wiper lag
Chrysler 1974-On

UNIT PACKAGE: 25



20312
(GM: 15021761;
Chry: 5027550AB)
Yellow Nylon

Hood Prop Rod Clip
7mm Rod Diameter
Snaps Into 10mm Hole
GM Cars & Trucks
Chrysler PT Cruiser
Isuzu Hombre
1990 - On

UNIT PACKAGE: 10



20419
(J4007456)
Black Nylon

Hood Prop Rod Clip
5/16" Rod Diameter
Overall Length: 1-3/8"
Mini-Vans
1997 - On

UNIT PACKAGE: 10



21034
(6506804-AA)
White Nylon

Door Lock Rod Clip
Right-Hand Side
Rod Size: 3mm (1/8")
Chrysler Mini-Vans
2002 - On
Dodge Caliber & Jeep Compass
2007 - On

UNIT PACKAGE: 15



21035
(6506807-AA)
White Nylon

Door Lock Rod Clip
Left-Hand Side
Rod Size: 3mm (1/8")
Chrysler Mini Vans
2002 - On
Dodge Caliber & Jeep Compass
2007 - On

UNIT PACKAGE: 15



15673
(3454220,
4658676)
Red Nylon

Door Lock Rod Clip
Used On Right-Hand Side
Rod Size: 5/32"
Chrysler 1972 - On

UNIT PACKAGE: 50



15674
(3454221,
4658677)
Green Nylon

Door Lock Rod Clip
Used On
Left-Hand Side
Rod Size: 5/32"
Chrysler 1972 - On

UNIT PACKAGE: 50

FasTrack
Auveco's Cost
Recovery System For
Repair Fasteners.....

Never Lose Money
On Fasteners Again!



Right-Hand Side Left-Hand Side

10262
Nylon

Door Lock Rod & Hood
Latch Locking Push Rod Clip
Rod Size: 5/32"
Fits Into 1/4" Hole
Chrysler, Ford, GM & AMC

UNIT PACKAGE: 20 Pieces
10 Rights - 10 Lefts

20675
(AMC: 4003672R;
Chry: 2945108R, 4658676;
GM: 16627328;
Ford: N805350S)
White Nylon

Clip For Right-Hand Side Only

UNIT PACKAGE: 25

14967
(AMC: 4003673L;
Chry: 2945109L, 4658677;
GM: 9815325, 16607593;
Ford: D2VZ-6521952A, N804344S)
Black Nylon

Clip For Left-Hand Side Only

UNIT PACKAGE: 50



20307
Not Supplied
By O.E.M.
Black Nylon

Sliding Door Lock Rod Clip
Used On Left-Hand Side
Rod Size: 5mm
Fits Into 7mm Hole
Full-Size Vans
1997 - On

UNIT PACKAGE: 10



20308
Not Supplied
By O.E.M.
Black Nylon

Sliding Door Lock Rod Clip
Used On Right-Hand Side
Rod Size: 5mm
Fits Into 7mm Hole
Full-Size Vans
1997 - On

UNIT PACKAGE: 10



19191
(4658444)

Lavender Nylon

Door Lock Rod Clip
Right-Hand Side
Rod Size: 1/8"
Chrys. Neon, Cirrus,
Stratus & Jeep Cherokee
1995-On

UNIT PACKAGE: 25



19190
(4658445)

Orange Nylon

Door Lock Rod Clip
Left-Hand Side
Rod Size: 1/8"
Chrysler Neon, Cirrus,
Stratus & Jeep Cherokee
1995-On

UNIT PACKAGE: 25



10080
(6027924)

Radiator Grille
Panel Upper
Support Baffle Retainer
Chrysler

UNIT PACKAGE: 100



19152
(6031875)

Grille Bar Clip
Chrysler 1981-On

UNIT PACKAGE: 50



19784
(6036042AA)
Zinc Organic

Door Window
Moulding Nut
M4.2 (#8) Screw Size
LH & LHS
1998 - On

UNIT PACKAGE: 25



19310
(6034336, 6034812,
6035807)
Phosphate

Door Panel Nut
#6 Screw Size
Cirrus,
Concorde,
Intrepid, LHS,
Stratus &
Eagle Vision
1993-On

UNIT PACKAGE: 25



20941
(6506109-AA)
Black Zinc

Front Bumper Cover
Retainer Nut
M4.8 (#10) Screw Size
Fits Into 12mm Square Hole
Chrysler Mini-Van & Pacifica
2002 - On

UNIT PACKAGE: 25



19519
(GM: 16662182; Chrys: 6502988)
Zinc Organic

Front Bumper, Grille Mounting
& Headlight Cover Fastener
Chrysler Sebring
1996 - On
GM
1993 - On

UNIT PACKAGE: 15



19339
(4676356)
Phosphate

Grille To Fascia Fastener
Town & Country,
Caravan and Voyager
1997-On

UNIT PACKAGE: 15



20526
(4805570-AA)
Black

Radiator Grille
Cover Fastener
26mm Wide, 26mm Long
Caravan, Town & Country
And Voyager Mini-Vans
1996 - On

UNIT PACKAGE: 10



19794
(6503174)
Phosphate

Cowl, Pillar &
Door Panel Fastener
Width: 7/16"
Length: 19/32"
Mini-Vans
& Jeep Cherokee
1996 - On

UNIT PACKAGE: 25



16729
(4198993)

Door Window Opening
Moulding Clip
Dodge & Plymouth
Daytona,
Pacifica, Shelby & Laser
1984-On

UNIT PACKAGE: 50



18102
(Ford: N806624-S191;
Chry: 6502776)

Rear Light Assembly Retainer
UNIT PACKAGE: 25



19779
(6503812, 6504601)
Zinc & Yellow

Wheel Opening Moulding Nutsert
M5 - .8 Thread
Head Diameter: 10mm
Can Be Set With
Auveco 11805 Tool
Overall Length: 12mm
Jeep 1999 - On

UNIT PACKAGE: 15



20173
(6506104AA)
Zinc & Yellow

Roof Rack Nutsert
With Sealer Under Head
M6-1.0 Thread
Grip: .7mm - 3.2mm
Head Diameter: 17mm
9.5mm (3/8") Hex
Can Be Set With
Auveco Tool 11805
Jeep 1999 - On

UNIT PACKAGE: 10



21019
(6509106-AA)
Zinc

M6-1.0 Thread Specialty
Insert With Sealer
Grip Range: .70mm - 3.17mm
Head Diameter: 17mm
Hex Size: 9.5mm
Luggage Rack & Bumper
Fascia
Chrysler Jeep & Van
Can only be set with
Pneumatic Tool

UNIT PACKAGE: 15

Dodge Truck Door Hinge Bolt & Bushing Repair Kit

For 2003 - 1994 Dodge Ram 1500, 2500 & 3500 Pick-Up Trucks



20544

Door Hinge Bolt & Bushing Repair Kit

UNIT PACKAGE: 1 Kit

Why bother with the hassle of cutting and grinding off a worn door hinge and welding on a new one when you can repair the bad hinge in a fraction of the time?

With our Door Hinge Bolt & Bushing Repair Kit, fixing sagging doors caused by worn hinges due to pin or bushing failure is quick. It's easy. It works. And you don't have to paint the welded heat flash area.

Each kit is designed to repair one hinge and contains one zinc and yellow dichromate plated grade 8 bolt, two self-lubricating brass alloy bushings, one zinc plated spin lock nut and one zinc plated internal lock washer.

Here's how easy it is:

1. Remove the door from the truck body.
2. Grind or cut off the end of the pin at the peaned end.
3. Remove the old pin and bushings.
4. Install the bushings into the hinge holes.
5. Place the washer on the bolt and install the bolt into the bushings.
6. Thread the nut onto the bolt and tighten.
7. Reattach the door to the truck body.



Detailed instructions are included with the kit.

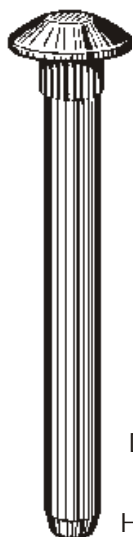

14562
(6028993,
6032975)

Door Hinge Pin
Length: 2-3/4"
Pin Dia: 17/64"
Head O.D.: 9/16"
Cargo doors,
lift gates, rear doors
and fold-up rear
seat floor hinges
on Dodge &
Plymouth vans,
Ramcharger
and Trailduster
1970-On

UNIT PACKAGE: 10



14561
(6500361)
Zinc

Door Hinge Pin
Length: 2-1/4"
Pin Dia: 1/4"
Chrysler
1980-On

UNIT PACKAGE: 10



17167
(4336115)

Door Hinge Bushing
Front & Rear Doors
Aries, Caravelle, LeBaron, Reliant,
Town & Country and 600
1989-85
O.D.: 3/8"
I.D.: 1/4"
Length: 13/32"
Flange O.D.: 1/2"

UNIT PACKAGE: 25



17434
(2486468)

Door Hinge Bushing
Chrysler Vans
1982-78
O.D.: 27/64"
I.D.: 11/32"
Length: 7/16"
Flange O.D.: 19/32"

UNIT PACKAGE: 25



14552
(4033711)

Door Hinge Bushing
Cargo doors, lift gates,
rear doors and fold-up rear seat
floor hinges on Dodge &
Plymouth vans, Ramcharger
and Trailduster
1970-On
O.D.: 5/16"
I.D.: 17/64"
Length: 23/64"
Flange O.D.: 33/64"

UNIT PACKAGE: 25

AMC CLIPS & FASTENERS

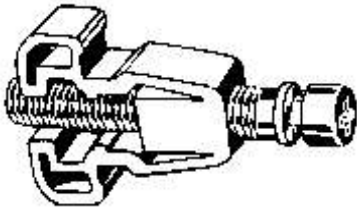

11470
 (AMC: SF 400 6204;
 GM: 1606642,
 1618890)
 1/4"-28 x 1-7/8"
 Headlight Adjusting Screw & Nut
 AMC & Cadillac
 1975-On

UNIT PACKAGE: 25



Right-Hand Side Left-Hand Side

10262
 Nylon

Door Lock Rod & Hood
 Latch Locking Push Rod Clip
 Rod Size: 5/32"
 Fits Into 1/4" Hole
 Chrysler, Ford, GM & AMC

UNIT PACKAGE: 20 Pieces
 10 Rights - 10 Lefts

20675

(AMC: 4003672R;
 Chry: 2945108R, 4658676;
 GM: 16627328;
 Ford: N805350S)
 White Nylon

Clip For Right-Hand Side Only

UNIT PACKAGE: 25

14967

(AMC: 4003673L;
 Chry: 2945109L, 4658677;
 GM: 9815325, 16607593;
 Ford: D2VZ-6521952A, N804344S)
 Black Nylon

Clip For Left-Hand Side Only

UNIT PACKAGE: 50



13036
 Black

Window Crank
 Handle Knob
 AMC

UNIT PACKAGE: 2



11697
 (4000141)
 Nylon

#6 or #8 Screw Size
 AMC

UNIT PACKAGE: 50



2272
 (3426388)

Front Fender and Door
 Quarter Panel Moulding
 Fastener:
 Rambler

UNIT PACKAGE: 100

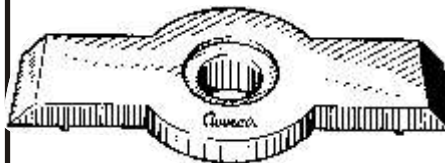

15813
 (4005714)
 Nylon

Window Glass Retainer
 AMC Eagle 1988-On

UNIT PACKAGE: 25

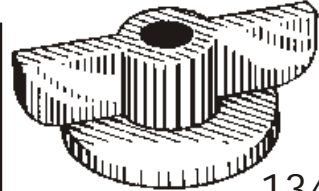

13472
 (Ford 386285;
 AMC 3230375)
 Nylon

Air Cleaner Wing Nut
 Self-Threading
 1/4", 6mm
 AMC & Ford

UNIT PACKAGE: 10

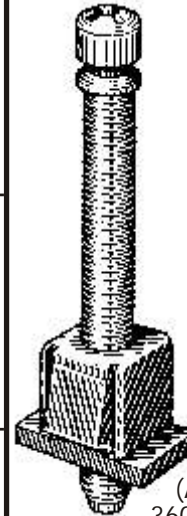

15666
 (AMC: 36000148,
 36001966, 56001419;
 VW: 176 941 1117A)

1/4"-28 x 2-1/4"
 Headlight Adjusting Screw
 and Nut Assembly
 AMC Encore &
 Alliance 1983-On
 VW

UNIT PACKAGE: 10

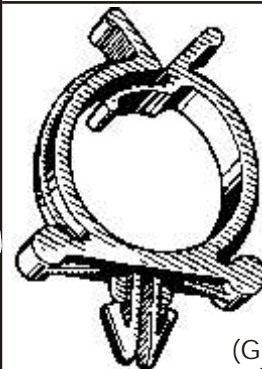

14217
 (GM: 1257702,
 20346654;
 Ford: 383207-S;
 AMC: 3693099)
 Nylon

Routing Clip
 GM / Ford / AMC

UNIT PACKAGE: 25