

18357
(F4ZZ-13032C,D)

Headlight Vertical Adjuster
Mustang
1994-On

UNIT PACKAGE: 2

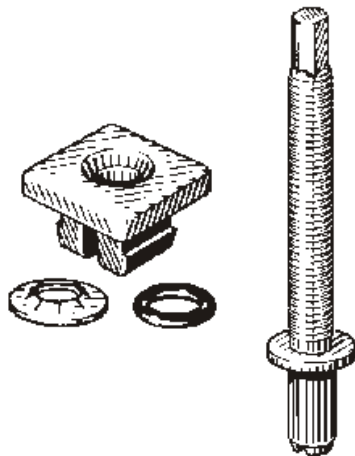

15968
(E6DZ-13032A)

Adjusting Screw Assembly
Hex & Slotted Drives
Taurus & Sable 1988-86

UNIT PACKAGE: 10

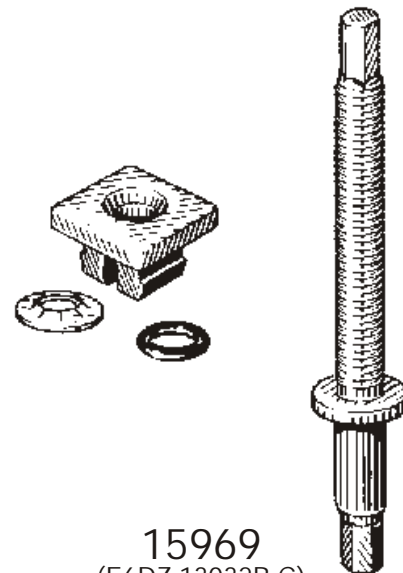

15969
(E6DZ-13032B,C)

Adjusting Screw Assembly
Hex Drives
Taurus & Sable 1986-On

UNIT PACKAGE: 10

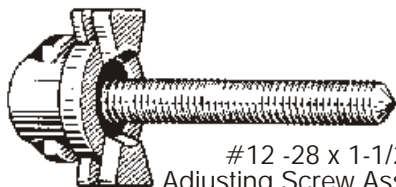

15966
(E7SZ-13032-D)

#12 -28 x 1-1/2"
Adjusting Screw Assembly
R.H. Upper, L.H. Lower
Phillips Drive
T-Bird, Cougar &
Continental 1988-87

UNIT PACKAGE: 5

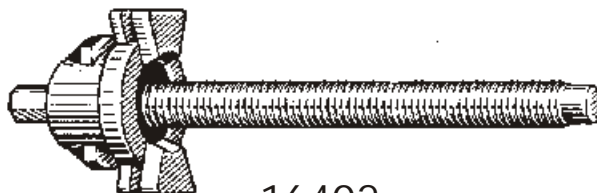

16402
(E7TZ-13032A, E7TB-13A093AB)

Upper Screw & Nut, Trucks F-U 150/350 1987-On

UNIT PACKAGE: 5

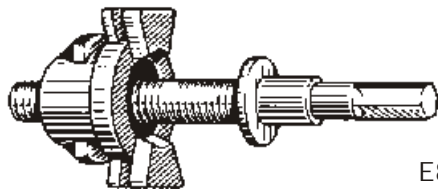

16733
(F03Z-13032A,
E83B-13A093-AA)

Vertical Adjuster
Tempo & Topaz 1990-On

UNIT PACKAGE: 5

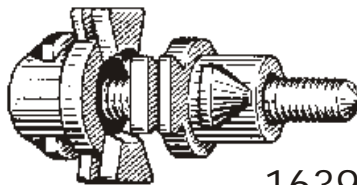

16399
(E9TZ-13032B, E97B-13A093BA)
Black Screw

Bronco & Ranger 1989-On

UNIT PACKAGE: 5

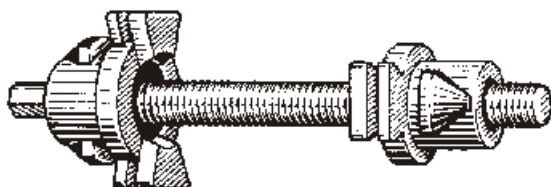

16396
(E8FZ-13032A, E8EB-13A093AA,
E8EB-13A093AB)

Vertical Adjuster, Escort & Lynx 1990-88

UNIT PACKAGE: 5

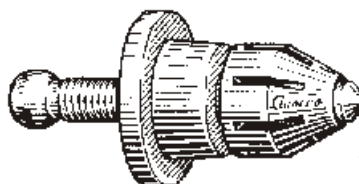

16406
(E9WY-13032C, E9WB-13A093CA)

Pivot Point Adjuster
Cougar 1989-On

UNIT PACKAGE: 10

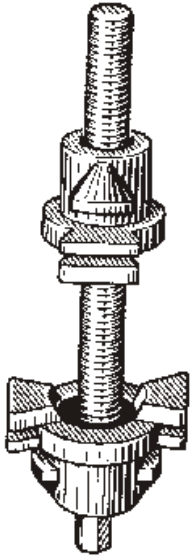

16397
(E8FZ-13032B,
E8EB-13A093BA)

Horizontal Adjuster, Escort & Lynx
1990-88

UNIT PACKAGE: 5



16405
(E9WY-13032B, E9WB-13A093BA)

Vertical Adjuster
Cougar 1989-On

UNIT PACKAGE: 10



11660
(DOZB-13A-093-AA)
Zinc Screw &
Phosphate Plate

1/4"-28 x 2"
Headlight Adjusting Screw
& Nut Assembly
Ford Cars & Medium Duty Trucks
1973-On

UNIT PACKAGE: 10

11661

Same as 11660
Except Packing

UNIT PACKAGE: 25

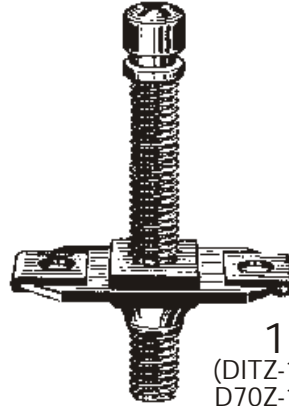

11662
(DITZ-13032B,
D70Z-13032B,
D7SZ-13032A,
D70B-13A-093-AA)
Zinc Screw & Phosphate Plate

1/4"-28 x 1-3/4"
Headlight
Adjusting Screw
& Nut Assembly
Ford 1973-On

UNIT PACKAGE: 10

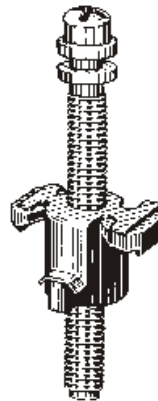

12609
(D9ZB-13A093 AA)
#12-28 x 1-3/4"
Headlight
Adjusting Screw
& Nut Assembly
Ford 1979-On

UNIT PACKAGE: 10

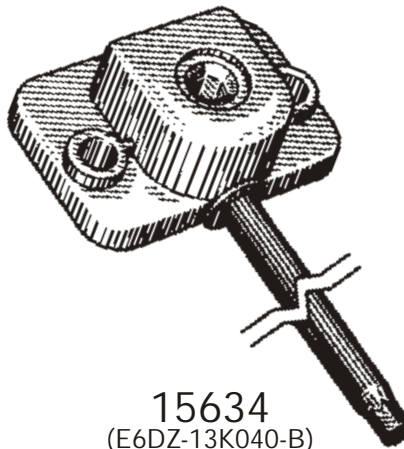

15634
(E6DZ-13K040-B)
Headlight Adjuster
Escort & Lynx 1985-On
Sable & Taurus 1986-On

UNIT PACKAGE: 1

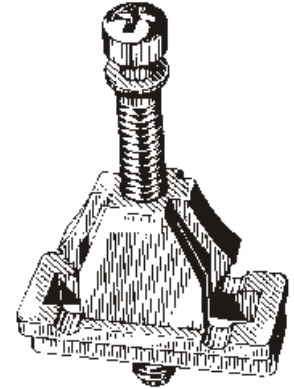

11869
(D8BZ-13032A, B,
D8BB-13M-093AA)
Zinc

#12-28 x 1-3/4"
Headlight Adjusting
Screw & Nut Assembly
Ford 1978-On

UNIT PACKAGE: 10

11870
Same as 11869 Except Packing

UNIT PACKAGE: 100



Auveco's FasTrack
INDUSTRIAL COST RECOVERY SYSTEM

Auveco's Cost
Recovery System
For
Repair Fasteners

Never Lose Money
On Fasteners Again!

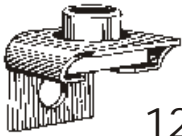

12228
(FDA13021-A)
Zinc-Nylon Nut

1/4"-28 Thread
Headlight Adjusting Nut Mount
Ford Product 1980-On

UNIT PACKAGE: 10



18263
(F37Z-13N129-A)
Black

Headlight Component
Retaining Clip
Mustang & Ranger 1993-On

UNIT PACKAGE: 25



14768
(D9BZ-5401316-B)
Black Nylon

Cowl Panel Grommet
#6 Screw Size
Fits Into 9/32" x 7/16" Hole
Ford 1979-On

UNIT PACKAGE: 25

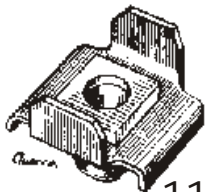

11669
(DZAB-13021-AA)
Black Phos.

1/4"-28 Thread
Headlamp Adjusting Nut Mount
Light Duty Trucks 1976-On

UNIT PACKAGE: 25



15814
(E5LB-13A147AA,
E5LY-13A147A)

Headlight Adjuster Retainer
Escort & Lynx 1985-On
Lincoln Mark VI, VII 1985-On
Mercury 1985-On
Tempo & Topaz 1986-On

UNIT PACKAGE: 25

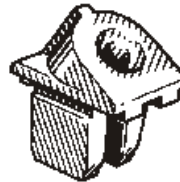

18155
(N803768-S)
Natural Nylon

Door Arm Rest Nut
#8 Screw Size
Mustang & Capri
1987-On

UNIT PACKAGE: 15



18899
(F1CZ-13A147A)
Black Nylon

Headlight Pivot Socket
Escort & Tracer
1991-On

UNIT PACKAGE: 25



18384
(W700800-S300)
Black Nylon

Nylon Grommet
Back Lower Finish
Panel Assembly
Contour & Mystique
1995-On

UNIT PACKAGE: 50



15940
(E9DB-13N020AA, E9DZ-13N129A)

Headlight Component
Pivot Retaining Clip
Ford Taurus & T-Bird 1989-On
Mercury Cougar & Sable
1989-On

UNIT PACKAGE: 25

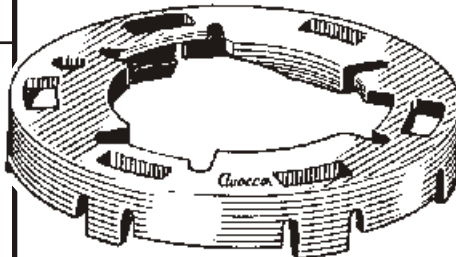

16425
(E9SZ-13N019B,
E9SB-13N019-BA)
Nylon

High Beam 9005 Bulb Retainer
Ford T-Bird & Cougar 1989-On

UNIT PACKAGE: 10



19280
Black Nylon

Door Window Glass
To Regulator Nut
Contour & Mystique
1995-On

UNIT PACKAGE: 5



19281

(F5RZ-5421416B)

Door Window Glass
To Regulator Fastener
Assembly
3/8"-16 x 3/4" Grade 8
Cap Screw
Contour & Mystique
1995-On

UNIT PACKAGE: 2 Sets



9862

(379830-S)
White Nylon

Headlight Door, Grille
& Mirror Nut
#8 or #10 Screw Size
Fits Into 1/4" Sq. Hole
Ford

UNIT PACKAGE: 50



14755

(379830-S)
White Nylon

3/8" Wide, 3/8" Long
#8 Screw Size
Fits Into 1/4" Sq. Hole
Ford 1986-On

UNIT PACKAGE: 25



14756

(Ford: 379830-S;
Chry: 6033677)
Black Nylon

3/8" Wide, 3/8" Long
Fits Into 9/32" x 9/32" Hole
Panel Thickness: 1/4"
#8 Screw Size
Ford & Chrysler 1986-On

UNIT PACKAGE: 25



20245

(N806334-S)
Natural Nylon

Nylon Nut
M4.2 (#8) Screw Size
Head Size: 10mm x 10mm
Fits Into 6mm Square Hole
Ford
1999 - On

UNIT PACKAGE: 50



18383

(W700566-S300)
Natural Nylon

#12 Screw Size
Back Panel Attachment
Contour & Mystique
1995-On

UNIT PACKAGE: 25



11865

(GM: 1255823;
Ford: 389360S)
Natural Nylon

Tail Light Nut
#6 or #8 Screw Size
Ford 1981-On
Front End Bezel Nut
GM 1979-On

UNIT PACKAGE: 50



12569

(Ford: N801706-S;
Chry: 6501773)
Black Nylon

Ford 1981-On
#10 Screw Size

UNIT PACKAGE: 25



14754

(N802376-S)
Blue Nylon

1/4" Long, 3/8" Wide
Fits Into 7/32" x 7/32" Hole
Panel Thickness: 5/32"
#8 Screw Size
Ford

UNIT PACKAGE: 25



20927

(N811478-S100)
Black Nylon

License Plate & Rear Bumper
Nylon Nut With Sealer
M6.3 (#14) Screw Size
Head Size: 16mm x 16mm
Stem Length: 8mm
Fusion & Mustang
2005 - ON

UNIT PACKAGE: 15



19277

(N804765-S)
Natural Nylon

Wheel Opening
Screw Grommet
#8 (M4.2) Screw Size
Mustang, T-Bird, Cougar &
Continental
1993-On

UNIT PACKAGE: 50



20939

(W711412-S300)
Natural Nylon

Rear Bumper
Screw Grommet
M4.2 (#8) Screw Size
Head Size:
9.5mm x 9.5mm
Stem Length: 12mm
Fusion
2006 - On

UNIT PACKAGE: 50



20393

(W706575-S300)
Natural Nylon

Door Panel Screw Grommet
M4.2 (#8) Screw Size
Stem Length: 20mm
Fits Into 10mm Square Hole
Ford Escape
2001 - On

UNIT PACKAGE: 50



20425
(F5RZ-17K657-A)
Natural Nylon

Windshield Washer Reservoir Mounting Screw Grommet
Use with #12 Screw
Head Dia: 1"
Overall Length: 13/16"
Fits Into 3/8" Sq. Hole
Ford Contour, Focus & Mystique
1995 - On

UNIT PACKAGE: 25



19326
(N807706-S)
Natural Nylon

Front Bumper Fascia Grommet
Escort, Explorer & Mustang
1996-On

UNIT PACKAGE: 25



20532
(W708045-S300)
Black Rubber

Rear Bumper Cover Grommet
Head Diameter: 15mm
Stem Length: 21mm
Fits Into 9.5mm Hole
Use With Auveco 20531
Ford Expedition 2003 - On

UNIT PACKAGE: 25



11841
(N-800503S)
Black Nylon
Grille Attachment Nut
#6 Screw Size
Ford 1978-On

UNIT PACKAGE: 50



19267
(N806577-S)
Natural Nylon

Interior Trim Panel Screw Grommet
#8 (M4.2) Screw Size
E150/350 Vans
1992-On

UNIT PACKAGE: 50



19364
(N806795-S)
White Nylon

Headliner & Pillar Trim Panel Grommet
Taurus & Sable
1992-On

UNIT PACKAGE: 50



20466
(GM: 25649667;
Ford:
W705590-S300)
Natural Nylon

Screw Grommet With Sealer
M4.2 (#8) Screw Size
Head Size: 13mm x 22mm
Stem Length: 18mm
Back Glass Moulding & Interior Trim
Cadillac & Ford Windstar
1998 - On

UNIT PACKAGE: 15



20517
(W707606-S300)
Black Nylon

Rear Bumper Cover Screw Grommet
M4.8 (#10) Screw Size
Head Size: 18mm x 24mm
Stem Length: 14mm
Ford Escape
2001 - On

UNIT PACKAGE: 15



20336
(F7CZ-17C756-BA)
Black Nylon

Front & Rear Bumper Cover Grommet
Use With #12 Screw
Stem Length: 1/2"
Escort & Tracer
1997 - On

UNIT PACKAGE: 15



20264
(N806363-S)
White Nylon

Kick Panel Grommet
Head Dia: 23mm
Overall Length: 24mm
Used With Auveco Retainer 19760
Ford Ranger
1993-On

UNIT PACKAGE: 25



17317
(F1CZ-8A188-A)
Black Nylon

Radiator Grille Spacer
Ford Escort & Mercury Tracer
1991-On

UNIT PACKAGE: 25



20530
Not Available
From O.E.M.
Black Nylon

Radiator Shroud Air Deflector Retainer
Head Diameter: 20mm
Stem Diameter: 13mm
Stem Length: 16mm
Ford Expedition
2003 - On

UNIT PACKAGE: 50



17195
(Isuzu: 8942180270)
Black Nylon

Grille Clip
13mm Wide, 22mm Long
Ford Escort, Honda,
Isuzu, Mitsubishi & Plymouth Laser

UNIT PACKAGE: 25



20171
(N807189-S100,
N811353-S100)
White Nylon

Cowl Vent Grommet
M4.2 (#8) Screw Size
Fits Into 10mm x 14mm Hole
F150 Pickup, Expedition
& Windstar
1995 - On

UNIT PACKAGE: 10



19138
(Ford: F1CZ-5802316A;
Mazda: BW0A-50-792)
Black Nylon

Cowl Top Vent Grille Retainer
Ford Escort & Tracer
Mazda
1991-On

UNIT PACKAGE: 15



19238
(F6DZ-5402316-AA)
Natural Nylon

Cowl Top Vent Grille
Grommet
Use With Auveco 19237
Ford Taurus & Sable
1996-On

UNIT PACKAGE: 50



19237
(W701649-S,
W704881-S300)
Black Nylon

Cowl Top Vent Grille
Nylon Screw
#10 x 1-1/32"
9/16" Head O.D.
Use With Auveco 19238
Ford Taurus & Sable
1996-On

UNIT PACKAGE: 50



19517
(N811849-S300)
Black Nylon

Cowl Top Vent Grille
Nylon Screw
#10 x 2-1/16"
9/16" Head O.D.
Ford Trucks
1998 - On

UNIT PACKAGE: 25



17551
(Mazda: GJ21-50-H81)
Natural Nylon

Cowl Screen Grommet
Ford Probe 1988-On
Mazda 626 & MX6 1988-On

UNIT PACKAGE: 25



17552
(Mazda: GJ21-50-H82)
Natural Nylon

Cowl Screen Grommet
Ford Probe 1988-On
Mazda 626 & MX6 1988-On

UNIT PACKAGE: 25



17553
(Mazda:
KA01-50-H16)
Yellow Nylon

Rear Hatch Grommet
Ford Probe 1988-On
Mazda MX 6 1988-On
Use With 17554

UNIT PACKAGE: 25



17554
(Mazda:
KA01-50-H15A)
Black Nylon

Rear Hatch Retainer
Ford Probe 1988-On
Mazda MX6 1988-On
Use With 17553

UNIT PACKAGE: 25



18816
(N807994-S)
Black Nylon

Grille & Side Marker
Light Grommet
Fits Into 10mm Hole
Ford 1994-On

UNIT PACKAGE: 50



17667
Green Nylon

Tubular Nut
3/8" Hole Size
Lower Body Side Moulding
Lincoln Town Car
1990-On

UNIT PACKAGE: 25



19526
(N807247-S)
Natural Nylon

Rear Door & Back Window
Trim Panel Grommet
#12 - 24 Screw
Fits Into 1/2" Hole
Lincoln Town Car
1990 - On

UNIT PACKAGE: 25



19783
(N811169S,
W705550-S300)
White Nylon

Park & Turn Signal
Housing Grommet
7/32" Stud Size
Head Diameter: 13mm
Stem Length: 9mm
Fits Into 11mm Hole
F250 - F550 Trucks
1999 - On

UNIT PACKAGE: 50



19752
(Not Available
From O.E.M.)
White Nylon

Door Belt Moulding Clip
Taurus, Sable
Contour & Mystique
1998 - 95

UNIT PACKAGE: 15



20400
(YF4Z-8194-AA)
Nylon

Radiator Grille Clip
Width: 1 1/32"
Length: 1-9/32"
Mercury Sable
2000 - On

UNIT PACKAGE: 15



19154
(E2EB-61290C62-AA)
Nylon

Body Side Moulding Clip
Escort & Lynx
1981-On

UNIT PACKAGE: 25



17451
(Mazda: H001-68-719B)
Nylon

Rocker Scuff Plate Retainer
Ford Probe 1988-On
Mazda MX6 1988-On
UNIT PACKAGE: 25

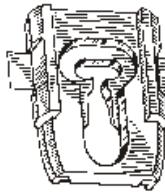

12559
(D5UB-2221066AA)
Nylon

Moulding
Ford 1980-On
UNIT PACKAGE: 50

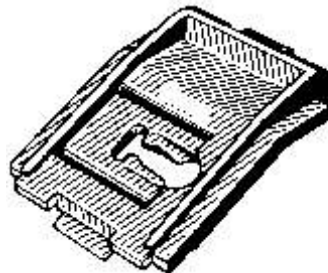

14137
(D8BB-7420828-AA)
Nylon

Moulding Clip
Ford 1978-On

UNIT PACKAGE: 25

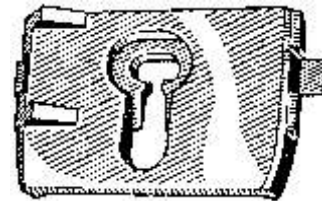

14213
(D42B-6021066BA)
Nylon
Mustang Body Side Moulding
UNIT PACKAGE: 25

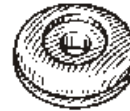

15812
(E7ZB-6120908AC)
Nylon

Door Retainer/Outside
Belt Moulding Clip
Ford Mustang 1987-On
UNIT PACKAGE: 50



12610
(D2SB-65045A28-AA,
N801829-S100)

Base Trim Panel Clip
Panel Range .090-.110
Escort, Lynx
1981-On

UNIT PACKAGE: 50

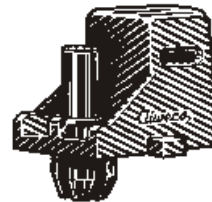

18377
(W701430-S300)
Black Nylon

Door Trim Retaining Clip
Contour & Mystique
1995-On

UNIT PACKAGE: 10

You Can E-mail
Your New Item
Suggestions To
mail@auveco.com



20862
(4L3Z-1510182-AA)
Black Nylon

Roof Garnish
Moulding Clip
Tip To Tip: 42mm
Front To Back: 12mm
Height: 21mm
Ford F-150
2005 - On

UNIT PACKAGE: 15



20817
(W701528-S300)
White Nylon

Moulding Clip
With Sealer
Top Head Size: 14mm x 20mm
Bottom Head Size: 15mm x 20mm
Stem Length: 12mm
Fits Into 9mm Hole
Lincoln Navigator
2003 - On

UNIT PACKAGE: 15



21009
(YL8Z-7820806-AA)
White Nylon

Body Side & Rocker Panel
Moulding Clip
Top Head Size: 13mm x 25mm
Bottom Head Size: 13mm x 18mm
Stem Length: 10mm
Fits Into 9mm Hole
Escape
2001 - On

UNIT PACKAGE: 10



20980
(6G1Z-5410182-D)
Gray Nylon

Rocker Panel
Moulding Clip
Head Size:
11mm x 16mm
Overall Length: 19mm
Ford 500
2005 - On

UNIT PACKAGE: 25



20867
Not Available From O.E.M.
Purple Nylon

Rocker Panel Moulding Clip
With Sealer
Top Head Size:
9/16" x 25/32"
Bottom Head Size:
19/32" x 25/32"
Stem Length: 7/16"
Fits Into 7/16" Hole
Ford
2004 - On

UNIT PACKAGE: 15



20968
Not Available From O.E.M.
Yellow Nylon

Wheel Lip Moulding Clip
Head Size: 15mm x 51mm
Stem Length: 11mm
Fits Into 10mm Hole
Expedition & Navigator
1998 - On

UNIT PACKAGE: 15



20979
(6G1Z-5410182-C)
Blue Nylon

Wheel Flare &
Rocker Panel
Moulding Clip
Top Head Size:
14mm x 18mm
Bottom Head Size
14mm x 18mm
Stem Length: 11mm
Fits Into 9mm Hole
Ford 500
2005 - On

UNIT PACKAGE: 25



20981
Not Available From O.E.M.
White Nylon

Wheel Flare
Moulding Clip
With Sealer
Top Head Size
14mm x 29mm
Bottom Head Size:
14mm x 29mm
Stem Length: 16mm
Fits Into 9mm Hole
Explorer 2006 - On

UNIT PACKAGE: 15



21000
(F57B-16241-AA)
White Nylon

Fender Moulding Clip
Head Size: 15mm x 51mm
Stem Length: 11mm
Fits Into 8mm Hole
Explorer & Others
2005 - On

UNIT PACKAGE: 15



20358
(F6DZ-5410182-AA)
Black Nylon

Rocker Panel Moulding Clip
Head Size: 13mm x 39mm
Stem Length: 14mm
Fits Into 9mm Hole
Sable, Taurus & Lincoln LS2000
1996 - On

UNIT PACKAGE: 10



20965
(F4ZZ-6310182-A)
Black Nylon

Rocker Panel and
Ground Effects
Moulding Clip
Head Size:
16mm x 50mm
Stem Length: 14mm
Fits Into 9mm Hole
Mustang
1995 - On

UNIT PACKAGE: 15

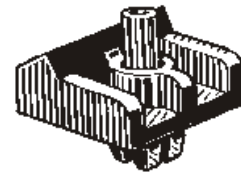

18498
(W700614S300)
Black Nylon

Door Trim Clip
Contour & Mystique
1995-On

UNIT PACKAGE: 10



20663
(F57Z-16241-AB,
W709767-S300)
Black Nylon

Rocker Panel
Moulding Clip
Head Size: 14mm x 40mm
Stem Length: 11mm
Ford Mustang
2001 - On

UNIT PACKAGE: 15



20978
(6G1Z-5410182-B)
Gray Nylon

Rocker Panel
Moulding Clip
Head Size:
22mm x 48mm
Stem Length: 14mm
Fits Into 9mm Hole
Ford 500
2005 - On

UNIT PACKAGE: 15

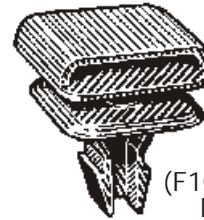

17602
(F1CZ-61101B04-A)
Natural Nylon

Body Side & Rocker Panel
Moulding Clip
Escort GT 1991-On

UNIT PACKAGE: 15



18822
(Ford: KA80-51-RF5A)
Nylon

Body Side Garnish
Moulding Clip Mazda
Millenia & Ford Probe
1995-On

UNIT PACKAGE: 15

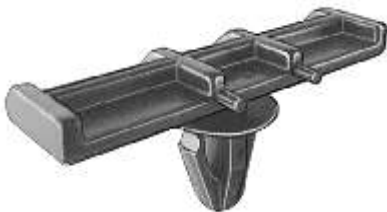

19441
(F1TZ-7810182-A)
Black Nylon

Rocker Panel
Ground Effects
Moulding Clip
Explorer,
Expedition & F150
1991-On

UNIT PACKAGE: 25



20977
(6G1Z-5410182-A)
Gray Nylon

Rocker Panel
Moulding Clip
Top Head Size:
22mm x 30mm
Overall Height: 18mm
Ford 500
2005 - On

UNIT PACKAGE: 15



20392
Not Supplied By O.E.M.
White Nylon

Moulding Clip
Head Diameter: 3/4"
Stem Length: 15/32"
Fits Into 5/16" Hole
Ford Expedition, Explorer
& Mountaineer
2001 - On

UNIT PACKAGE: 10



20355
(W705849-S300)
Nylon

Front End Moulding Clip
Top Head Size: 1/2" x 13/16"
Bottom Head Size:
11/16" x 25/32"
Stem Length: 3/8"
Ford
2000 - On

UNIT PACKAGE: 10



20936
(W707388-S300)
Black Nylon

Front Bumper Cover
Moulding Clip
Bottom Head Size: 18mm x 20mm
Stem Length: 10mm
Fits Into 8mm x 12mm Hole
Escape
2001 - On

UNIT PACKAGE: 10



19345
(W702412-S300)
Nylon

Pillar Trim Clip
Contour & Mystique
1995-On

UNIT PACKAGE: 50



18882
(Ford: KA80-51-PR6;
Mazda: EA01-50-048)
Black Nylon

Body Side Lower
Wide Moulding Grommet
Ford Probe & Mazda MX6
1993-On

UNIT PACKAGE: 10



19805
(W703507-S300)
Natural Nylon

Wheel Opening
Moulding Clip
Head Diameter: 18mm
Stem Length: 8mm
Focus
2000 - On

UNIT PACKAGE: 25



20306
(W703505-S301)
Zinc Organic

Wheel Opening
Pushnut Retainer
Retainer Diameter: 22mm
Used With Auveco
Wheel Opening
Moulding Clip 19805
Focus
2000 - On

UNIT PACKAGE: 25



19413
(F7UZ-15238A32)
Black Nylon

Door Panel Screw Cover
Head Diameter: 3/4" (19mm)
Fits Into 5/8" (16mm) Hole
Ford Econoline E150
1997 - On

UNIT PACKAGE: 25



20194
(W701223-S300)
Black Nylon

Cowl Grille Screw Cover
13mm O.D.
Use With Auveco Fastener 20193
Contour, Focus & Mystique
1995 - On

UNIT PACKAGE: 50



20193
(W703842-S300,
W703919-S300)
Black Nylon
w/ Zinc & Yellow Screw

Cowl Grille Fastener
Nylon Retainer
Length Under Head: 38mm
Replaces Auveco 18497
Contour, Focus & Mystique
1995 - On

UNIT PACKAGE: 15



14953
(Ford: N803494S;
GM: 15679091)
Black Nylon

Fascia, Trim & Grille
Retainer
Head Size: 15/32" x 15/32"
Stem Length: 21/32"
Fits Into 1/4" Square Hole or Slot
Aerostar, Escort & Lynx
1985-On
GM 1994 - On

UNIT PACKAGE: 25

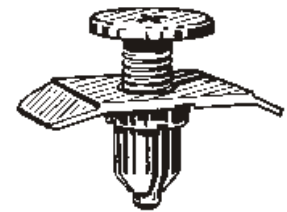

17450
(Ford: E8BZ-17C756C,
Mazda: BF67-50-235)
Black Nylon

Bumper Cover Retainer
Head Size: 20mm x 30mm
Stem Length: 11mm
Fits Into 10mm Hole
Ford Festiva 1988-On
Mazda 323 1986-On

UNIT PACKAGE: 10



15366

(Ford: E7GZ-17A904-B;
Mazda: BF67-50-033)
Gray Nylon

Bumper Retainer
Head Size: 20mm x 30mm
Stem Length: 11mm
Fits Into 10mm Hole
Mercury Tracer 1987-On

UNIT PACKAGE: 10

Please Order In
Unit Package
Quantities not
Number Of Pieces



17060

(Ford: E92Z-17C756C;
Mazda: GJ21-50-034)
Black Nylon

Bumper Cover Retainer
Head Size: 20mm x 30mm
Stem Length: 20mm
Fits Into 10mm Hole
Ford Probe &
Mazda MX6 1989-On

UNIT PACKAGE: 10



20923

(Ford: 3M8Z-1502316-A;
Mazda: GJ6E-50-715A)
Black Nylon

Cowl Vent
Push-Type Retainer
Head Size: 8.5mm x 12mm
Stem Length: 9mm
Fits Into 5mm Hole
Fusion, Milan & Zephyr
2006 - On
Mazda 5 & 6
2003 - On

UNIT PACKAGE: 15



14988

(N805229S)
Black Nylon

Push-Type Retainer
Head Diameter: 7/16"
Stem Length: 11/16"
Fits Into 15/64" Hole
Ford 1987 - On

UNIT PACKAGE: 25

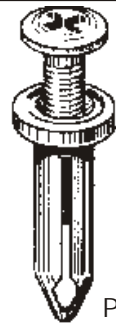

14995

(GM: 10195515;
Ford: N805026S;
Chrys: 4696488,
6503163)
Black Nylon

Push-Type Retainer
Head Diameter: 1/2"
Stem Length: 1-13/64"
Fits Into 9/32" Hole
GM, Ford & Chrysler
1987 - On

UNIT PACKAGE: 25



14992

(Ford: N803946S;
Chrys: 6502871)
Black Nylon

Push-Type Retainer
Head Diameter: 19/32"
Stem Length: 29/32"
Fits Into 1/4" Hole
Ford & Chrysler 1987 - On

UNIT PACKAGE: 50



18667

(F3XY-12044A59-C)
Gray Nylon

Rear Quarter
Trim Panel
Push-Type Retainer
Head Diameter: 5/8"
Stem Length: 29/32"
Fits Into 1/4" Hole
Mustang 1994-On

UNIT PACKAGE: 50



20191

(YS4Z-16K262-AA)
Black Nylon

Push-Type Retainer
Head Diameter: 16mm
Stem Length: 18mm
Fits Into 6mm Hole
Focus
2000 - On

UNIT PACKAGE: 25



18893

(N806322-S)
Black Nylon

Trim Panel
Push-Type Retainer
Head Diameter: 11/16"
Stem Length: 1/2"
Fits Into 1/4" Hole

UNIT PACKAGE: 15



14991

(GM: 10139822; 25680782;
Ford: N808147S)
Black Nylon

Push-Type Retainer
Head Diameter: 11/16"
Stem Length: 11/16"
Fits Into 1/4" Hole
GM & Ford 1987 - On

UNIT PACKAGE: 25

FasTrack
Auveco's Cost
Recovery System
For Repair Fasteners
Never Lose Money On
Fasteners Again.



18894
(N807578-S,
N808332-S)
Black Nylon

Trim Panel
Push-Type Retainer
Head Diameter: 11/16"
Stem Length: 3/4"
Fits Into 1/4" Hole

UNIT PACKAGE: 15



20545
(N811283-S)
Black Nylon &
Santoprene Rubber

Trim Panel
Push-Type Retainer
Head Diameter: 18mm
Stem Length: 18mm
Fits Into 6.3mm Hole
Ford Expedition & Navigator
1997 - On

UNIT PACKAGE: 25



19849
(Not Available
From O.E.M.)

Black Nylon & Santoprene Rubber
Bumper Push-Type Retainer
Head Diameter: 18mm
Stem Length: 18mm
Fits Into 8mm Hole
Taurus & Sable
2000 - On

UNIT PACKAGE: 25



14753
(GM: 20664092;
Ford: N804570S;
Chry: 4638136)
Black Nylon

Trim Retainer
Head Dia: 11/16"
Stem Length: 7/8"
Fits Into 1/4" Hole
Ford 1986-On
Chrysler 1998 - On

UNIT PACKAGE: 25



21098
(Ford: W706092-S300;
Chrysler: 6508197-AA)
Black Nylon

Front Air Shield,
Splash Guard &
Heat Shield
Push-Type Retainer
Head Diameter: 18mm
Stem Length: 18mm
Fits Into 6.4mm Hole
Ford Taurus 2008 - On
Dodge Ram 2006 - On

UNIT PACKAGE: 25

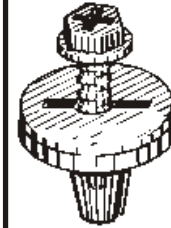

13469
(N802737-S)
Black Nylon

Under Hood Retainer
Head Diameter 3/4"
Stem Length 1/2"
Fits Into 1/4" Hole
Tempo & Topaz

UNIT PACKAGE: 25



18895
(N807577-S,
N808331-S)
Black Nylon

Trim Panel
Push-Type Retainer
Head Diameter: 11/16"
Stem Length: 1-3/32"
Fits Into 1/4" Hole
Aerostar & Windstar

UNIT PACKAGE: 15



20367
(W706713-S300)
Black Nylon

Bumper Cover
Push-Type Retainer
Head Diameter: 18mm
Stem Length: 18mm
Fits Into 8mm Hole
Ford Escape
2001- On

UNIT PACKAGE: 25



16858
(Nissan: 63844-01A00;
Ford: MNA01-56145,
NA01-56145; Kia:
MNA01-56-145; Mazda:
NA01-56-145)
Black Nylon

Push-Type Retainer
Head Dia: 20mm
Stem Length: 18mm
Fits Into 8mm Hole
Nissan 1980-On
Probe & Aspire 1995-On
Kia & Mazda

UNIT PACKAGE: 25



17632
(Mazda: B092-51-833;
Ford: MB-455-56143)
Black Nylon

Push-Type Retainer
Head Diameter: 18mm
Stem Length: 12mm
Fits Into 8mm Hole
Mazda & Ford Aspire

UNIT PACKAGE: 10



21089
(W710250-S300)
Black Nylon

Rear Bumper Retainer
Head Diameter: 18mm
Stem Length: 18mm
Fits Into 8mm Hole
Edge 2007 - On

UNIT PACKAGE: 25



14994
(N804837S)
Black Nylon

Push-Type Retainer
Head Diameter: 1"
Stem Length: 29/32"
Fits Into 1/4" Hole
Ford 1987 - On

UNIT PACKAGE: 50



11702
(D6EA-1A100-AA)
Natural Nylon

Wheel Ornament
Push-Type Retainer
Head Diameter: 25/64"
Stem Length: 19/32"
Fits Into 9/32" Hole
Ford 1976 - On
UNIT PACKAGE: 50



11706
(387944-S)
Black Nylon

Grille To Metal
Stamping Retainer
Head Dia: 3/4"
Shoulder Length: 1/4"
Stem Length: 11/16"
Fits Into 1/4" Wide Slot
Ford Truck 1978-On
UNIT PACKAGE: 50



20516
(W706182-S300)
Black Nylon

Headlight Mounting
& Deck Lid
Push-Type Retainer
Head Diameter: 20mm
10mm Hex
Stem Length: 13mm
Fits Into 8mm Hole
Ford Expedition, Explorer &
Focus
2000 - On
UNIT PACKAGE: 25



11705
(387843-S)
Black Nylon

Fender Shield Retainer
Head Dia: 19/32"
Stem Length: 5/8"
Fits Into 1/4" Hole
Ford 1978-On
UNIT PACKAGE: 50



20233
(W705956-S300)
Black Nylon

Cowl Push-Type Retainer
Head Diameter: 25mm
Shoulder Diameter: 10mm
Shoulder Length: 3mm
Stem Length: 12mm
Fits Into 9mm Hole
Lincoln LS
1999 - On
UNIT PACKAGE: 15



19638
(Chrys: 4805405AA;
Ford:
1L5Z-17K826AA)
Black & White Nylon

Push-Type Retainer
Head Dia.: 34mm
Stem Length: 20mm
Fits Into 8mm Hole
Chrysler
1998-On
Ford Trucks
2005 - On
UNIT PACKAGE: 15



20310
(383142-S)
Black Nylon

Grille To
Headlight Bracket
Push-Type Retainer
Head Diameter: 5/8"
Stem Length: 7/16"
Fits Into 1/4" Hole
Replaces Auveco 10214
Ford
UNIT PACKAGE: 50



15522
(N805231S)
Black Nylon

Push-Type Retainer
Head Diameter: 5/8"
Stem Length: 17/32"
Fits Into 1/4" Hole
Taurus, Topaz & Sable
1989-On
UNIT PACKAGE: 50



20273
(Ford: N808791;
Chrys: 5GC71RC3AA,
5GF92RC3AA)
Gray Nylon

Interior Trim, Dash & Console
Push-Type Retainer
Head Dia: 19mm
Shoulder Dia: 10mm
Shoulder Length: 7mm
Stem Length: 22mm
Fits Into 9mm Hole
Dodge Durango & Ford Pick-Ups
1997 - On
UNIT PACKAGE: 25



19607
(XL3Z-17E971-AA)
Natural Nylon

Front Bumper Cover
Push-Type Retainer
Head Dia.: 16mm
Stem Length: 12mm
Fits Into 10mm Hole
F150 & F250 Trucks
1999-On
UNIT PACKAGE: 25



18860
(N805017SW)
Black Nylon

Luggage
Compartment
Trim Attachment
Push-Type Retainer
Head Diameter: 1"
Stem Length: 9/16"
Fits Into 1/4" Hole
Taurus & Sable
1991-86
UNIT PACKAGE: 15

FORD PRODUCTS CLIPS & FASTENERS

Sec. 20



17478
(Mazda: B101-68-252-00)
Black Nylon

Interior Trim
Push-Type Retainer
Head Diameter: 14mm
Stem Length: 16mm
Fits Into 6mm Hole
Ford Probe 1988-On
Mazda MX6 1988-On
UNIT PACKAGE: 25



17222
(Ford: F3LY-14570-B;
GM: 21075686)
Black Nylon

Push-Type Retainer
Head Diameter: 15mm
Stem Length: 20mm
Fits Into 8mm Hole
Rocker Panel, Wheel Liner
& Air Inlet Duct Applications
Ford
GM Saturn 1991 - On
UNIT PACKAGE: 25



17103
(GM: 15681408;
Ford: N803709S)
Black Nylon

Fascia Attachment
Push-Type Retainer
Head Dia: 15mm
Stem Length: 23mm
Fits Into 6mm Hole
GM & Ford 1986-On
UNIT PACKAGE: 50



13993
(Ford: N803362-S;
GM: 20510029,
Chry: 34202672)
Black Nylon

Body Retainer
Head Dia: 11/16"
Stem Length: 7/8"
Fits Into 1/4" Hole
Ford 1984 - On
GM 1984 - On
UNIT PACKAGE: 25



21024
(5R3Z-54310D12-AAA)
Black Nylon

Trim Panel
Push-Type Retainer
Head Diameter: 18mm
Stem Length: 10mm
Fits Into 6mm Hole
Mustang
2005 - On
UNIT PACKAGE: 15



18206
(GJ21-68885-B69)
Gray Nylon

Push-Type Retainer
Head Diameter: 18mm
Stem Length: 12mm
Fits Into 6mm Hole
Probe & Mazda MX6
1989-On
UNIT PACKAGE: 25

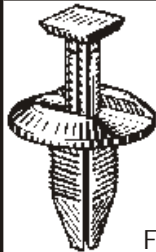

16726
(N808048S,
W705532-S300)
Black Nylon

Front Bumper
Stone Deflector Retainer
Head Dia: 18mm
Stem Length: 18mm
Fits Into 6.3mm (1/4")
Square Hole
Bronco, Ranger
& Explorer 1989-On
UNIT PACKAGE: 25



20989
(GM: 11589291;
Ford: W713331-S300)
Black Nylon

Air Dam & Grille
Push-Type Retainer
Head Diameter: 18mm
Stem Length: 22mm
Panel Range:
7.0mm - 9.5mm
Fits Into 6.5mm Hole
GM 2003 - On
Ford
UNIT PACKAGE: 25



14018
(N803716-S)
Black Nylon

Fascia Retainer
Head Dia: 18mm
Stem Length: 23mm
Fits Into 7mm Hole
Mustang/Capri
1985-On
UNIT PACKAGE: 25



17216
(GM: 21030249;
Ford: N807389S;
Chry: 6503598)
Nylon

Air Baffle To
Under Carriage
Push-Type Retainer
Head Diameter: 20mm
Stem Length: 20mm
Fits Into 8mm Hole
UNIT PACKAGE: 25



20889
(GM: 11589293;
Ford:
W712196-S300)
Black Nylon

Cowl Vent & Fender
Push-Type Retainer
Head Diameter: 20mm
Stem Length: 22mm
Panel Range:
4.5mm - 7.0mm
Fits Into 8.5mm Hole
GM 1997 - On
Edge, Fusion,
Lincoln MKX, Milan
And Zephyr
2006 - On
UNIT PACKAGE: 25



20632
(GM: 11518017,
Ford: W708530-S300)
Black Nylon

Bumper Cover &
Fender Shield
Push-Type Retainer
Head Diameter: 20mm
Stem Length: 26mm
Fits Into 8mm Hole
GM & Ford
1997 - On
UNIT PACKAGE: 15



20993
(GM: 11589295;
Ford: W712665-S300)
Black Nylon

Fender, Flare, Gas Tank
& Panel Attachment
Push-Type Retainer
Head Diameter: 25mm
Stem Length: 20mm
Panel Range:
3.0mm - 6.0mm
Fits Into 10.5mm Hole
GM 2005 - On
Ford

UNIT PACKAGE: 25

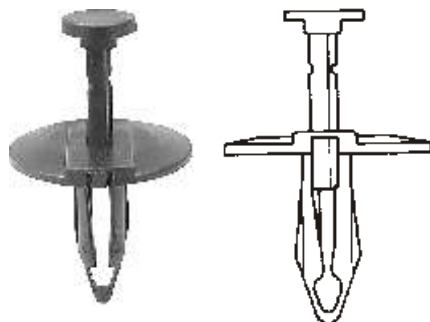

14020
(Ford: N802781-S;
GM: 14093088)
Black Nylon

Splash Shield & Fascia Retainer
Head Dia: 1"
Stem Length: 7/8"
Fits Into 1/4" Hole

UNIT PACKAGE: 25



18503
(W701054-S300)
Black Nylon

Front Bumper
Push-Type Retainer
Head Diameter: 1"
Stem Length: 1"
Fits Into 5/16" Hole
Contour & Mystique
1995-On

UNIT PACKAGE: 25

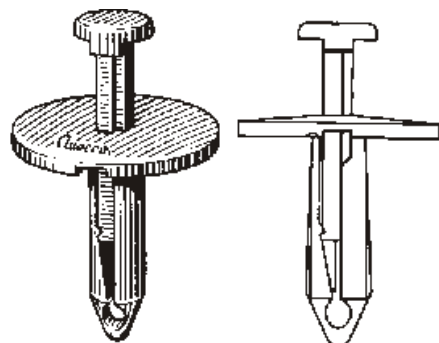

15701
(N804674-S)
Black Nylon

Push-Type Retainer
Head Dia: 25mm
Stem Length: 27mm
Fits Into 7mm Hole
Mustang & Capri

UNIT PACKAGE: 50

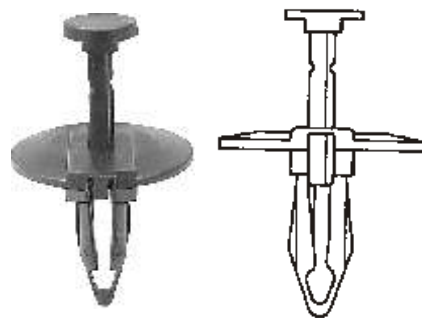

14019
(Ford: N803421-S,
Chry: 6501590)
Black Nylon

Splash Shield & Fascia Retainer
Head Dia: 1"
Shoulder Length: 1/8"
Stem Length: 7/8"
Fits Into 5/16" Hole

UNIT PACKAGE: 25



19337
(N808908-S)
Black Nylon

Headlight Accessory
Push-Type Retainer
Head Diameter: 14mm
Stem Length: 23mm
Fits Into 6.3mm (1/4") Hole
Mustang
1996 - On

UNIT PACKAGE: 10



19244
(N808847-S)
Black Nylon

Trunk Trim Panel
Push-Type Retainer
Head Diameter: 1"
Stem Length: 11/16"
Fits Into 1/4" Square Hole
Taurus & Sable
1996-On

UNIT PACKAGE: 25



13994
(GM: 20570245;
Ford: N804614S)
Black Nylon

Spare Tire Retainer
Head Dia: 1"
Stem Length: 7/8"
Fits Into 5/16" Hole

UNIT PACKAGE: 25



20518
(W705957-S300,
W706519-S300)
Black Nylon

Radiator Sight Shield
Push-Type Retainer
Head Diameter: 24.5mm
Stem Length: 14mm
Fits Into 9mm Hole
Lincoln LS 2000 - On

UNIT PACKAGE: 10



20169
(W701971-S)
White Nylon

Door Trim Panel
Push-Type Retainer
Head Diameter: 15mm
Stem Length: 13mm
Fits Into 7mm Hole
Lincoln LS
2000 - On

UNIT PACKAGE: 25



20363
Not Available
From O.E.M.
White Nylon

Door Trim Panel
Push-Type Retainer
Top Head Diameter: 15mm
Bottom Head
Diameter: 20mm
Overall Length: 32mm
Fits Into 9mm Hole
Ford 2001 - On

UNIT PACKAGE: 25



19511
(W704958-S300)
White Nylon

Rear Door
Lower Trim Panel
Push-Type Retainer
Round Head Diameter: 19/32"
Wedge Shaped Head
Diameter: 29/32"
Stem Length: 11/16"
Fits Into 3/8" Hole
Lincoln Town Car
1998 - On

UNIT PACKAGE: 25



20970
Not Available
From O.E.M.
Black Nylon

M14 x 34mm
Bumper and Door Insulator
Nylon Screw
22mm Head O.D.
No. 3 Square Drive
Fits Into 12mm Hole
GM, Ford & Chrysler
2005 - On

UNIT PACKAGE: 25



19472
(GM: 25535963;
Ford: N811772S)
Nylon

Upper Deflector Shield

UNIT PACKAGE: 25



9426
(C7AB-14A163-B)

Horn Wire Retainer
Tube Size 1/4"
Ford

UNIT PACKAGE: 50



18386
(W701133-S300)
Black Nylon

Routing Clip
Contour & Mystique
1995-On

UNIT PACKAGE: 25

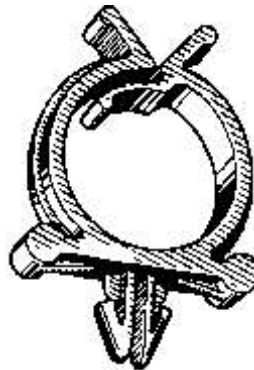

14217
(GM: 1257702,
20346654;
Ford: 383207-S
AMC: 3693099)
Nylon
Routing Clip

UNIT PACKAGE: 25

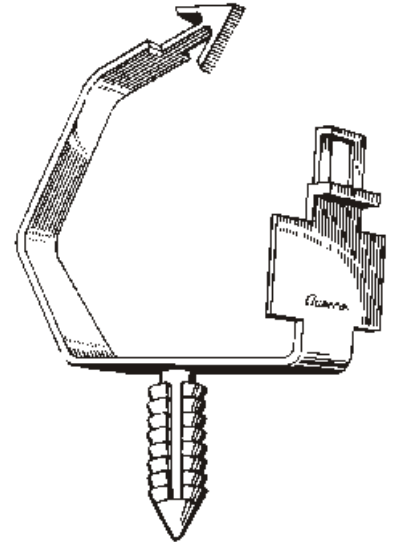

12622
(D9AB-14A163JC)
Nylon

Wire Routing Clip
Stem: 5/16" x 3/4" Long
Ford 1980-On

UNIT PACKAGE: 25



12133
(EOVB-13A506-BA)
Nylon

Clip Retainer
Stem: 9/32" x 15/32" Long
Ford 1979-On

UNIT PACKAGE: 50



17164
(EOVY-13A506-A)
Nylon

Rear Light
Wiring Retainer
3/8" Wide, 1-7/16" Long
Stem: 9/32" x 7/16" Long
Ford 1979-On

UNIT PACKAGE: 50



20569
(E9DB-14A163CA,
F1TZ-14A163E)
Natural Nylon

Wiring Routing Clip
Head Size: 10mm x 31mm
Stem Diameter: 7mm
Stem Length: 11mm
Ford
1989 - On

UNIT PACKAGE: 25



20482
(2F1Z-9A317-AA)
Natural Nylon

Fuel Line Retainer Clip
For 5/16" Fuel Line
Ford Taurus & Mercury Sable
6 Cylinder 3.0 L Engine
With Fuel Injection
2002 - On

UNIT PACKAGE: 25

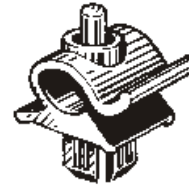

18504
(W702380-S300)
Yellow Nylon

Hood Prop Rod Clip
Fits 6mm Rod
Contour & Mystique
1995-On

UNIT PACKAGE: 5

Inquire About Our
FasTrack Cost
Recovery Program
For Body Shops

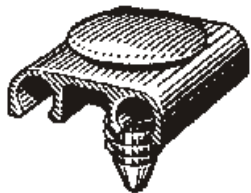

15524
(E6DC-2B223AA,
E9SC-2B223AA)
Nylon

Clip Assembly
For Brake Tube
Length: 1"
Holds 3/16" O.D. Tube
Fits Into 1/4" Hole
Cougar XR7 & T-Bird
UNIT PACKAGE: 10



17643
(N802239-S,
N806191-S1901)
Natural Nylon

Fuel Line Retainer Clip
For 5/16" Fuel Line
Ford (With Fuel Injection)
1980-On

UNIT PACKAGE: 25

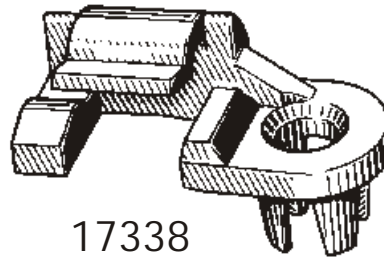

17338
(D5ZZ-16828A)
Nylon

Hood Prop Rod Clip
7/32" Rod Diameter
Ford/Mercury Bobcat, Cougar,
Fairmont, Granada, Monarch,
Mustang, Pinto, Thunderbird, Zephyr
& E100/350 1991-75

UNIT PACKAGE: 15



17642
(N802241-S,
N806190-S1901)
Black Nylon

Fuel Line Retainer Clip
For 3/8" Fuel Line
Ford (With Fuel Injection)
1980-On

UNIT PACKAGE: 25

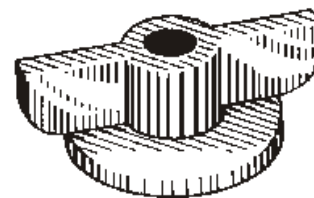

13472
(Ford: 386285,
AMC: 3230375)
Nylon

Air Cleaner Wing Nut
Self Threading
1/4", 6mm
Ford and AMC

UNIT PACKAGE: 10



20483
(2F1Z-9A317-BA)
Black Nylon

Fuel Line Retainer Clip
For 3/8" Fuel Line
Ford Taurus & Mercury Sable
6 Cylinder 3.0 L Engine
With Fuel Injection
2002 - On

UNIT PACKAGE: 25

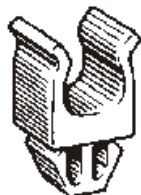

16954
(386299-S)
Nylon

Hood Prop Rod Clip
5/16" Rod Diameter
Ford Cars 1975-On

UNIT PACKAGE: 25

Please Order
In Unit Package
Quantity Not Pieces



19536
(F65Z-15020C34-AA)
Black Nylon
Cowl Vent Plug
Head Diameter: 2 1/32"
Expedition & F150/250
1996 - On
UNIT PACKAGE: 25



17613
(N802190-S53)
Phosphate
Wheel Ornament Retainer Nut
M4.2-1.81 (#8) Screw Size
Aerostar, Bronco II, Explorer &
Ranger
1983-On
UNIT PACKAGE: 100



12606
(E1EB-61046A48-BA)
Lower Finish Panel Clip
Ford 1981-On
UNIT PACKAGE: 25



10837
(D3AA-90826-AA)
Nylon
Speed Control Rod to
Throttle Pivot
Ford
UNIT PACKAGE: 10



14820
(N803685S)
Dash Panel Nut
Screw Size: #8 (M4.2-1.41)
Taurus/Sable
UNIT PACKAGE: 25

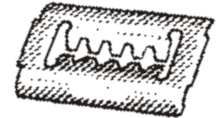

17003
(Ford: F32Z-17C756-S
Mazda: GJ21-50-049)
Bumper Cover Retainer
Front & Rear Bumpers
Ford Festiva 1988-On
Mazda 1988 - On
UNIT PACKAGE: 50

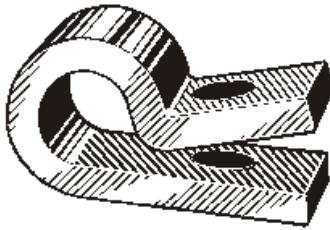

18387
(91GBA611A08BEAW)
Nylon
Headrest Clamp
Contour & Mystique
1995-On
UNIT PACKAGE: 10



19823
(N806511-S32)
Phosphate & Olive Drab
Parking Light Retainer Nut
Screw Size: #8 (M4.2 - 1.41)
Ford Vans
1997 - On
UNIT PACKAGE: 25



20546
(N808342-S307)
Black Phosphate
Air Cabin Filter Fastener
Size: 5/8" x 25/32"
Ford Taurus & Sable
1995 - On
UNIT PACKAGE: 50



18102
(Ford: N806624-S191;
Chry: 6502776)
Rear Light Assembly
Retainer
Ford Explorer
1991-On
UNIT PACKAGE: 25



19677
(N804741-S2)
Black Phosphate
Instrument Panel Fastener
Use With 5/16"
Tapping Screw
Head Size: 9/16" x 5/8"
Overall Length: 1"
LTD, Mercury
Marquis & Trucks
1996 - On
UNIT PACKAGE: 10



12610
(D2SB-65045A28-AA
N801829-S100)
Base Trim Panel Clip
Panel Range .090-.110
Escort, Lynx
1981 - On
UNIT PACKAGE: 50



14819
(N803968-S100)

Bumper Strip Retainer
25/32" Long, 9/32" Wide
Taurus/Sable

UNIT PACKAGE: 50

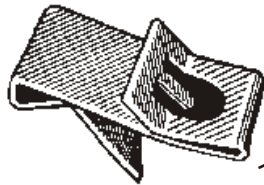

14895
(Ford: N803638-S36B)

Top Vent Grille (Water Deflector)
Mounting Clip
Escort & Lynx 1984-On

UNIT PACKAGE: 25



20401
(W706172-S309,
W708384-S309)
Zinc & Yellow

M6-1.0 Specialty Insert With Sealer
Grip: .5mm-4.2mm
Head Diameter: 13mm
Hex Size: 9.5mm
Roof Rack
Ford Escape, Excursion, Expedition,
Explorer, Navigator & Mountaineer
2000 - On

Can be set with
Auveco Tool 11805

UNIT PACKAGE: 15



19838
Not Available From O.E.M.
Dacromet 320

Front Bumper
Chrome Strip Fastener
Size: 5/8" x 1"
Flange Size: 7/32" x 1"
Grip Range: .039" - .098"
(1mm - 2.5mm)
Ford Explorer
1999 - On

UNIT PACKAGE: 10



20396
Zinc & Yellow

1/4" - 20 Specialty Insert
Grip: .030" - .165"
Head Diameter: 1/2"
Hex Size: 3/8"
Can be set with
Auveco Tool 11805

UNIT PACKAGE: 15



20421
(N811257-S100)
Zinc & Olive Drab

M5-.8 Specialty Insert With Sealer
Grip: .5mm-2.5mm,
Head Diameter: 10mm,
Hex Size: 7mm
General Purpose
Ford Escape, Excursion, Expedition,
Explorer, Navigator & Mountaineer
2001 - On

Can be set with
Auveco Tool 11805

UNIT PACKAGE: 15



20415
(GM: 15685099;
Ford: N803763-S100)
Zinc & Yellow

M6-1.0 Specialty Insert With Sealer
Grip: .65mm - 2.0mm
Head Diameter: 12mm
Hex Size: 8mm
Roof Rack, Tailgate
& General Purpose
GM APV Vans, C & K Trucks
And Ford Explorer
1991 - On

Can be set with
Auveco Tool 11805

UNIT PACKAGE: 15



19421
(F7UZ-1513284-BA)
Zinc Organic

Front Door Scuff
Plate Retainer
Econoline Van
E150/350
1997-On

UNIT PACKAGE: 25



20678
Zinc & Yellow

M5-.8 Specialty Insert
Grip: .5mm-3.3mm
Head Diameter: 10mm
Hex Size: 7mm
Can be set with
Auveco Tool 11805

UNIT PACKAGE: 15



19436
(N808182-S309)
Zinc & Yellow

Roof Rack
Mounting Nut Insert
M6 - 1.0 Thread
Grip: .7mm - 3.17mm
Head Diameter: 13mm
Explorer & Expedition
1997-On

Can Be Set With
Auveco Tool 11805

UNIT PACKAGE: 10



21020
(W701295-S301)
Zinc Organic

Front Bumper Cover
To Air Dam Fastener
Width: 13/16"
Length: 1-1/16"
Focus
2003 - On

UNIT PACKAGE: 10

FORD PRODUCTS CLIPS & FASTENERS

Sec. 20



20776
(W708513-S437)
Zinc

M8-1.25 Specialty Insert
Grip: .7mm - 3.8mm
Head Diameter: 22mm
Hex Size: 12.7mm
Frame Area
Ford Trucks
2004 - On

UNIT PACKAGE: 15

Not Actual Size

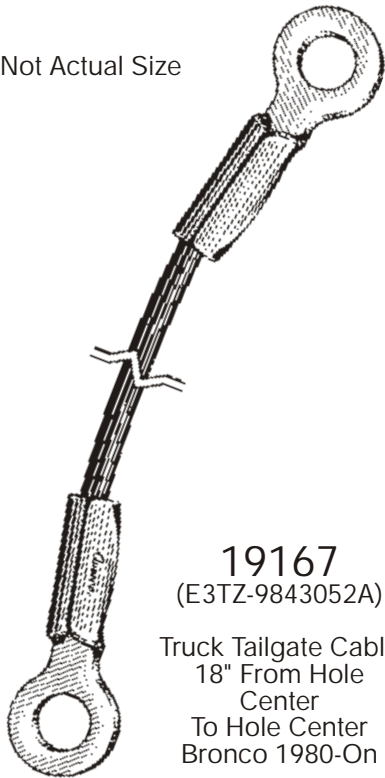

19167
(E3TZ-9843052A)

Truck Tailgate Cable
18" From Hole
Center
To Hole Center
Bronco 1980-On

UNIT PACKAGE: 1



20153
(YL3Z-1521970-AA)

White Door Lock Pawl
Right-Hand Side
Ford Continental, Contour,
Explorer, Mountaineer,
Mystique, Ranger, Sable
& Taurus And Mazda Truck
1996 - On

UNIT PACKAGE: 1



20195
(YL3Z-1521971-AA)

Pink Door Lock Pawl
Left-Hand Side
Ford Continental, Contour,
Explorer, Mountaineer,
Mystique, Ranger, Sable
& Taurus And Mazda Truck
1996 - On

UNIT PACKAGE: 1



17118
(E6DZ-5421971-A,
F3LY-6321971A)
Nylon

Door Lock Pawl
Left-Hand Side
Ford Taurus & Sable 1986-On

UNIT PACKAGE: 10



17119
(E6DZ-5421970-A,
F3LY-6321970-A)
Nylon

Door Lock Pawl
Right-Hand Side
Ford Taurus & Sable 1986-On

UNIT PACKAGE: 10



20630
(F8DZ-54265A99-AA)
White Nylon

Door Latch Guide
Width: 23mm
Length: 36mm
Taurus & Sable
1998 - On

UNIT PACKAGE: 15



Right-Hand Side Left-Hand Side

10262
Nylon

Door Lock Rod & Hood
Latch Locking Push Rod Clip
Rod Size: 5/32"
Fits Into 1/4" Hole
Chrysler, Ford, GM & AMC

UNIT PACKAGE: 20 Pieces

10 Rights - 10 Lefts

20675

(AMC: 4003672R;
Chry: 2945108R, 4658676;
GM: 16627328;
Ford: N805350S)
White Nylon

Clip For Right-Hand Side Only

UNIT PACKAGE: 25

14967

(AMC: 4003673L;
Chry: 2945109L, 4658677;
GM: 9815325, 16607593;
Ford: D2VZ-6521952A, N804344S)
Black Nylon

Clip For Left-Hand Side Only

UNIT PACKAGE: 50



15675
(E6AZ-5421952-A,
390523S)
Yellow Nylon

Door Lock Rod Clip
5/32" Rod Size
Ford Products 1986-On

UNIT PACKAGE: 25



19651
(F85Z-1521952-BB)
Yellow Nylon

Door Lock Rod Clip
Expedition & Navigator
F150, 250
1997 - On

UNIT PACKAGE: 10

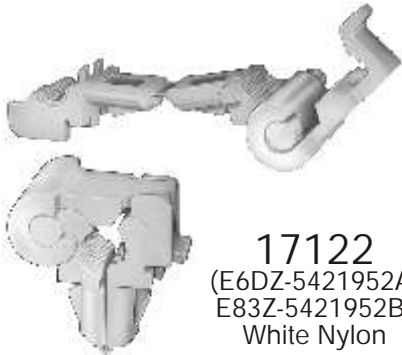

17122
(E6DZ-5421952A,
E83Z-5421952B)
White Nylon

Door Lock Rod End Clip
5/32" Rod Size
Taurus, Sable, Tempo, Topaz, T-Bird
& Cougar, Aerostar, Bronco,
Explorer, Mountaineer, Pick-Up,
Ranger & Windstar
1986-On

UNIT PACKAGE: 10



18914
Not Supplied
By O.E.M.
PVC Plastic

Door Lock Striker Bushing
1/2" I.D., 11/16" O.D.
7/8" Long
Ford 1972-On

UNIT PACKAGE: 50



18890
(E9AZ-5422008A)

Door Lock Striker
Bolt Assembly
M10-1.50 Thread
Ford, Mercury & Mustang
1991-83
Truck E100/300 & F100/350
1980-On

UNIT PACKAGE: 1

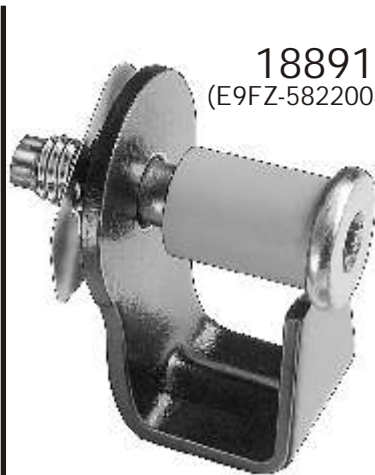

18891
(E9FZ-5822008-A)

Door Lock Striker Bolt Assembly
7/16"-14 Thread
Tempo, Topaz, Escort, Tracer,
Taurus, Sable, T-Bird, Cougar,
Lincoln, Aerostar, Bronco II,
Explorer & Ranger
1983-On

UNIT PACKAGE: 1

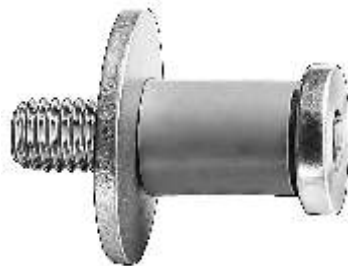

18892
(D2AZ-6522008-A)

Door Lock Striker
Bolt Assembly
7/16"-14 Thread
Cars 1980-73
E100/350 Vans
(Back Door) 1986-80

UNIT PACKAGE: 1

View the Auveco
Catalog on-line at
www.auveco.com
You can search by
Auveco part number,
description,
OEM number and
competitive
part number.

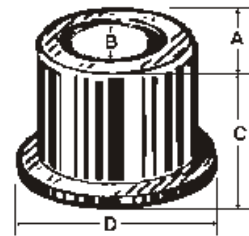

Door Hinge Bushings

Auveco Part No.	Dimensions			
	O.D. "A"	I.D. "B"	Height "C"	Flange O.D. "D"
14550	27/64"	11/32"	19/64"	19/32"
14551	31/64"	11/32"	19/64"	19/32"



14550
(D1AZ-6522841A)

Ford 1973-On
UNIT PACKAGE: 25



14551
(D90Z-6522841A)

Ford 1973-On
UNIT PACKAGE: 25

Body Hardware &
Specialty Fasteners
= Auveco



19594
(D9ZZ-6643030-AA)
Zinc Plated

Door Hinge Pin
Pin Diameter: 11/32"
Length Under Head: 3-3/8"
Head Diameter: 9/16"
Mustang 1993 - 79
Tempo & Topaz 1994 - 90
Capri 1986 - 80

UNIT PACKAGE: 10



20346
Not Available
From O.E.M.
Zinc & Yellow

Door Hinge Pin
Length: 3-1/2"
Pin Dia: 11/32"
Knurl Dia: .358"
Head O.D.: 9/16"
Use With Auveco 8829
E-Type Retaining Ring
Ranger, F150,
F250 & F350
1998 - 80

UNIT PACKAGE: 5



13030
(E2GZ-6723342A)
Black Nylon

Window Crank Handle

UNIT PACKAGE: 1



12470
(D1FZ-6222600-A,
D2FZ-6222600-A)

Door Handle

UNIT PACKAGE: 1

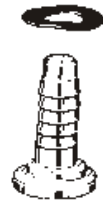

13032
Black

Window Crank
Handle Knob
Ford 1974-On

UNIT PACKAGE: 2