



17000
(16506582)

Horizontal Headlight Adjuster
Chevrolet Corsica
& Lumina (APV),
Olds Silhouette (APV)
and Pontiac Trans Sport (APV)
1987-On

UNIT PACKAGE: 2



11243
(343543, 343555,
354076, 362379)

1/4"-28 x 2"
Headlight Adjusting Screw & Nut Assembly
GM 1962-On

UNIT PACKAGE: 10

11244

Same as 11243 except packing

UNIT PACKAGE: 100



11245
(343543, 343555,
354076, 362379,)
Nylon

Headlight Adjusting Nut
GM 1962-On

UNIT PACKAGE: 50



11246
(343543, 354076,
9438150, 15705372)
Zinc

1/4"-28 x 2"
Headlight Adjusting Screw
GM 1962-On

UNIT PACKAGE: 25

Visit The
Auveco Web Site At
www.auveco.com For
The latest Information
On New Items.



11826
(365270)
Green Nylon

1/4"-28 x 2"
Headlight Adjusting
Screw & Nut
Assembly
Cars with Fiberglass
Panels
GM 1976-On

UNIT PACKAGE: 25



11655
(557057, 559312)
Nylon

#12-28 x 1-3/4"
Headlight Adjusting Screw & Nut
Assembly
GM 1975-On

UNIT PACKAGE: 25

11656

Same as 11655 except packing

UNIT PACKAGE: 100

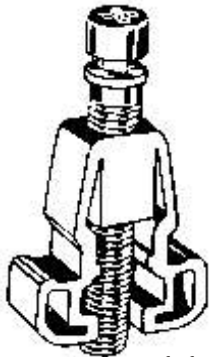

11470
(GM: 1606642,
1618890,
AMC: SF 400 6204)

1/4"-28 x 1-7/8"
Headlight Adjusting Screw & Nut
Assembly
Cadillac 1975-On & AMC

UNIT PACKAGE: 25



11718
(365270)
Green Nylon

Headlight Adjusting Nut
For Cars With Fiberglass Panels
GM
1976-On

UNIT PACKAGE: 50

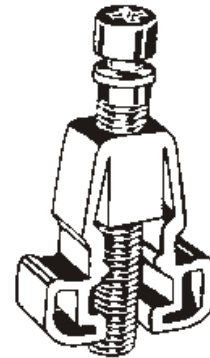

11657
(1606642,
1618890)

1/4"-28 x 1-7/8"
Headlight Adjusting Screw & Nut
Assembly
Cadillac & Oldsmobile 1975-On

UNIT PACKAGE: 100

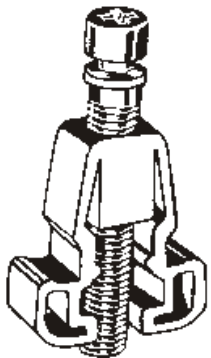

10759
(1600375)

1/4"-28 x 1-1/2"
Headlight Adjusting Screw & Nut
Assembly
Cadillac 1976-72

UNIT PACKAGE: 10



11665
(556196, 557057)
Nylon

#12-28 x 1-3/4"
Headlight Adjusting Screw
& Nut Assembly
GM 1975-On

UNIT PACKAGE: 25

FasTrack

Auveco's Cost Recovery System For Repair Fasteners.....

Never Lose Money On Fasteners Again!



11667
(556539)
Nylon

#12-28 x 1-3/4"
Headlight Adjusting Screw & Nut Assembly
Buick & Oldsmobile 1977-On
UNIT PACKAGE: 25

"If A Picture Is Worth A Thousand Words, Then A Sample Is Worth A Thousand Pictures."
"Pop" Gale

Call Our Customer Service Department When You Need A Sample...



12605
(22512857, 22513813)
Nylon

#12-28 x 1-3/4"
Headlight Adjusting Screw & Nut Assembly
Camaro & Firebird 1975-On
UNIT PACKAGE: 10



11871
(559312)
Nylon

#12-28 x 1-11/16"
Headlight Adjusting Screw & Nut Assembly
Chevrolet, Oldsmobile & Pontiac 1975-On
UNIT PACKAGE: 10



20947
(11561382, 11610198)
Blue Nylon

Headlight Grommet With Sealer
Head Size: 13mm x 20mm
Overall Length: 19mm
Pontiac G6 2005 - On
UNIT PACKAGE: 10



19549
(16506617)
Black Nylon

Headlight Adjuster Pivot
Fits Into 13mm Square Hole
Regal, Concours, Eldorado, Seville, Caprice, Lumina, Full-Size Van, Cutlass, Grand Am & Grand Prix
1987 - On
UNIT PACKAGE: 25



9851
(3921446)
White Nylon

Headlight Adjusting Nut
Use With 1/4"-28 Screw
Chevrolet
UNIT PACKAGE: 50



5788
Nylon

Headlight Adjusting Nut
Chevrolet: All Early Models
UNIT PACKAGE: 50

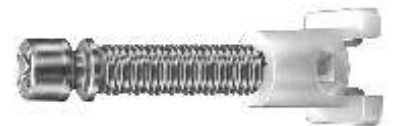

5789

Headlight Adjusting Screw & Nut Assembly
Chevrolet
UNIT PACKAGE: 25 Sets



3209
Zinc

1/4"-28 x 1"
Headlight Adjusting Screw
UNIT PACKAGE: 50



3178
(5949838)

Headlight Adjusting Screw & Nut
Assembly
Chevrolet, Buick & Pontiac
UNIT PACKAGE: 10 Sets



20378

Not Supplied By O.E.M.
White Nylon

Headlight Adjusting Screw Nut
Component of Auveco 3178
Headlight Adjusting Screw Assy.
Buick, Chevrolet & Pontiac

UNIT PACKAGE: 25

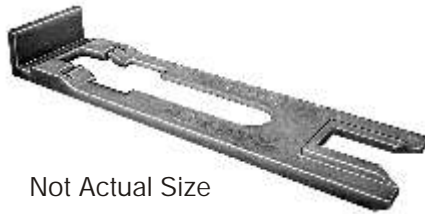

Not Actual Size

19486
(10298115)
Natural Nylon

Headlight Retainer
Width: 1-1/8"
Length: 4-9/16"
Buick Century & Regal
And Oldsmobile Intrigue
1997-On

UNIT PACKAGE: 10

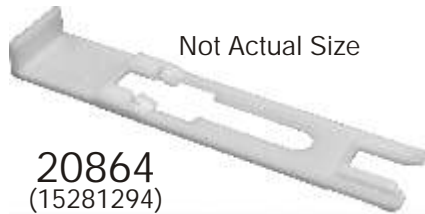

Not Actual Size

20864
(15281294)
White Nylon

Headlight Retainer
Width: 1-1/8"
Length: 5-9/16"
Chevrolet Impala & Monte Carlo
2006 - On

UNIT PACKAGE: 10



10090
(3923948)

Headlight Adjusting Spring
Chevrolet 1968-On

UNIT PACKAGE: 25

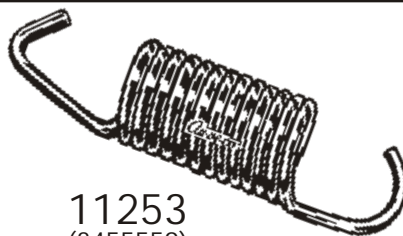

11253
(3455559)

Headlight Adjusting Spring
Chevrolet 1977-75

UNIT PACKAGE: 10

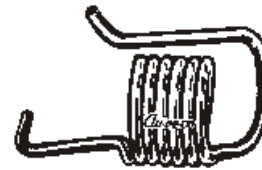

11252
(413851, 22537990)

Headlight Adjusting Spring
GM 1990-75

UNIT PACKAGE: 10



12136
(25501771)

#8 Screw
Headlight Panel Retainer
GM 1979-80

UNIT PACKAGE: 50



18928
(12337918)
Black Phosphate

Headlight Opening
Moulding Fastener
Pontiac Bonneville
1991-87

UNIT PACKAGE: 25

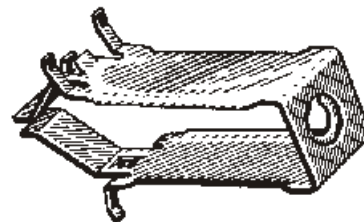

14821
(22514924)

Headlight Mounting Bezel Nut
Screw Size: #8 (M4.2-1.41)
2" Long
Oldsmobile 1982-On

UNIT PACKAGE: 25

GENERAL MOTORS CLIPS & FASTENERS Sec. 20



8942
(3863669)
Nylon

Radiator Grille to Headlight Nut
#8 or #10 Screw Size
Chevrolet

UNIT PACKAGE: 25



20433
(3547221)
Yellow Nylon

Nylon Nut
#6 Screw Size
Head Size: 3/8" x 3/8"
Moulding Attachment
1994 - On

UNIT PACKAGE: 50



13450
(347347)
Natural Nylon

Front Lights
#8 Screw Size
Panel Range: 1/16"-5/32"
GM 1967-On

UNIT PACKAGE: 50



13929
(10004329, 10009690)
Natural Nylon

Headlight Spacer Nut
GM 1979-On

UNIT PACKAGE: 25



15676
(16510893)
Natural Nylon

Composite Headlight Nut
#6 Screw Size
3/8" Sq. Head
Buick Electra (FWD)
1987-On

UNIT PACKAGE: 50



10330
(3893980)
Natural Nylon

Front End & Instrument Panel Nut
#8 Screw Size
GM 1967-On

UNIT PACKAGE: 100



18507
(15622475)
Nylon
Grille/Parking Light
Spacer Nut
GM Trucks
C & K, 1, 2, 3
1990-On

UNIT PACKAGE: 10



9829
(380382)
Natural Nylon

Headlight Bezel To Body Nut
#6 or #8 Screw Size
GM

UNIT PACKAGE: 50



11691
(3919773)
Natural Nylon

Headlight Bezel Nut
#8 Screw Size
GM 1974-On

UNIT PACKAGE: 100



14002
(16503329)
Black Nylon

#6 Screw Size
3/8" Sq. Head
Fits 1/4" Sq. Hole
GM

UNIT PACKAGE: 100



11424
(3985058)
Natural Nylon

Truck Grille Nut
#6 or #8 Screw Size
GM Trucks 1974-On

UNIT PACKAGE: 25



11838
(1254815)
Natural Nylon

#6 Screw Size
Panel Range: .060"-.150"
GM 1977-On

UNIT PACKAGE: 50

E-mail Your New
Product Suggestions
To mail@auveco.com



14003
(22514578)
Black Nylon

Parking Lamps
#8 Screw Size
GM 1982-On

UNIT PACKAGE: 25



13933
Natural Nylon

Grille Nut
#8 or #10 Screw Size
1/2" Head Size

UNIT PACKAGE: 50



11308
Nylon

Nylon Nut
#8 or #10 Screw Size

UNIT PACKAGE: 50



11855
(GM: 9669486;
Renault: 8934-201-262)
Natural Nylon

Side Marker Nut
GM 1980-On
Rear License Plate Bracket
AMC/Renault
#8 Screw Size

UNIT PACKAGE: 25



12735
(GM: 1370853;
Chry: 6029501;
VW: 179-813-883)
Natural Nylon

Headlight Bezel Nut
#6 Screw Size
GM, Chrysler & VW 1982-On

UNIT PACKAGE: 50



14145
(16503548)
Nylon &
Stainless Steel

Headlight Glass nut
GM 1983-On

UNIT PACKAGE: 25



13960
(14013246)
Natural Nylon

Headlight Bezel Nut
Fits Into 5/16" Hole
#8 Screw Size
GM 1967-On

UNIT PACKAGE: 50



10305
Nylon

Nylon Nut
#8 Screw Size

UNIT PACKAGE: 50



9069
(1355003)
Natural Nylon

Headlight Door to Radiator Grille
Anchor Nut
#6 or #8 Screw Size
Buick 1964-On

UNIT PACKAGE: 50



14031
(12337852,
15596279,
21035018)
Black Nylon

Grille Retainer & Cowl Vent Nut
#8 or #10 Screw Size
Astro, Safari & Saturn 1985-On

UNIT PACKAGE: 25



20584
(25647358)
Natural Nylon

Door Reveal Moulding
Screw Grommet
M4.2 (#8) Screw Size
Cadillac DeVille and Seville
1998 - On

UNIT PACKAGE: 25



14030
(GM: 3997391;
VW: 179-813-881)
Black Nylon

Tail Light Nut
#8 Screw Size
GM Astro & Safari
1985-On
Volkswagen

UNIT PACKAGE: 25



14014
(GM: 20475950,
20624923;
VW: 175-853-674)
Black Nylon

Air Vent Nut
Use w/14013
GM & VW

UNIT PACKAGE: 50



13827
(GM: 10027915)
Natural Nylon

Speaker Grommet
Pontiac Fiero

UNIT PACKAGE: 50

Remember...
All Items In
This Catalog
Are Available In Bulk.
Call For A Quote

GENERAL MOTORS CLIPS & FASTENERS Sec. 20

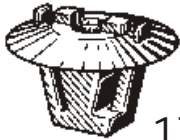

17271
(94113207)
Natural Nylon

Cowl Cover Retaining Clip
Head Diameter: 23mm
Chev. Spectrum
1989-85

UNIT PACKAGE: 15



19247
(10262143)
Black Nylon

Air Intake Grille
Panel Grommet
For 5mm Stud
Buick Regal & Century
Chevrolet Lumina & Monte Carlo
Oldsmobile Cutlass
Pontiac Grand Prix
1996-On

UNIT PACKAGE: 25

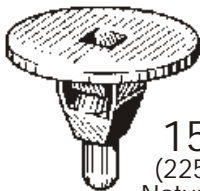

15992
(22529957)
Natural Nylon

Front Bumper Fascia Nut
Head Dia: 25mm (1")
Use with 4.2mm (#8) Screw
Oldsmobile Cutlass Ciera 1985-On

UNIT PACKAGE: 50



19542
(25632157)
Black Nylon

Headlight/Side Marker Light
Grommet
Fits Into 12mm Hole
Pontiac Bonneville
1996 - On

UNIT PACKAGE: 15



11836
(559547)
Natural Nylon
Screw Grommet
#14 Screw Size
GM 1960-On

UNIT PACKAGE: 25



19194
(Toyota: 90189-06028;
GM: 94854203)
Black Nylon

Front & Rear Wheel
Fender Liner Screw Grommet
#12 Screw Size
Head Diameter: 16mm
Stem Length: 19mm
Fits Into 9mm x 9mm Sq. Hole
Tacoma, T100 &
4 Runner
1992 - On
Chevrolet Nova & Prizm
And Pontiac Vibe
1985 - On

UNIT PACKAGE: 15



19676
(10277480)
Natural Nylon

License Plate Cover
Screw Grommet
M4.2 (#8) Screw Size
Head Diameter: 9/16"
Stem Length: 9/16"
Fits Into 1/4" Square Hole
Oldsmobile Intrigue
1998 - On

UNIT PACKAGE: 15



17230
(10027015)
Natural Nylon

Screw Grommet For
Engine Control Module
Overall Length: 1-3/16"
GM (All Divisions)
1977-On

UNIT PACKAGE: 10



20938
(11561655)
Black Nylon

Tail Light Grommet
With Sealer
Head Diameter: 15mm
Stem Length: 17mm
Fits Into 11mm Hole
Buick Terraza, Chevrolet
Uplander, GMC Arcadia,
Pontiac Montana SV6
And Saturn Relay
2005 - On

UNIT PACKAGE: 5

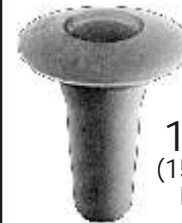

19429
(15954398)
Rubber

Tail Light Screw Grommet
Venture, Silhouette,
Transport, S & T Trucks
1995-On

UNIT PACKAGE: 25



11865
(GM: 1255823;
Ford: 389360S)
Natural Nylon

Front End Bezel Nut
#6 or #8 Screw Size
GM 1979-On
Tail Light Nut
Ford 1981-On

UNIT PACKAGE: 50



20452
(11517873)
Natural Nylon

Screw Grommet
Use With #12 Screw
Head Size: 5/8" x 3/4"
Stem Length: 9/16"
Door Handle
Chevrolet Impala &
Monte Carlo
2000 - On

UNIT PACKAGE: 15



14037

(GM: 15596280;
Chry: 6035274)
Black Nylon

Cowl Vent Nut
#6 or #8 Screw Size
GM Astro & Safari 1985-On

UNIT PACKAGE: 25



10727

(3986978)
Natural Nylon

Headlight Bezel Nut
#6 Screw Size
Chevrolet

UNIT PACKAGE: 25



12713

(GM: 10032838,
1264963;
Chry: 6031869;
AMC: 8934-201-602)
Natural Nylon

High Torque Screw Grommet
#6 Screw Size
GM, Chrysler & AMC-Renault
1978-On

UNIT PACKAGE: 25



10365

(1377030)
Natural Nylon

Valance Panel to Rear
Bumper Bar Grommet
#6 or #8 Screw Size
GM 1971-On

UNIT PACKAGE: 100



19435

(25526447)
Natural Nylon

Radiator Screw
Grommet
#6 Screw Size
Buick Century
1996 - 86

UNIT PACKAGE: 50



14009

(14032291)
Natural Nylon

Grille Attachment Grommet
#6 or #8 Screw Size

UNIT PACKAGE: 50



14220

(25525798,
22537749)
Natural Nylon

Grille Retaining Grommet
#8 Screw Size
GM 1985-On

UNIT PACKAGE: 50



20466

(GM: 25649667;
Ford:
W705590-S300)
Natural Nylon

Screw Grommet
With Sealer
M4.2 (#8) Screw Size
Head Size: 13mm x 22mm
Stem Length: 18mm
Back Glass Moulding
& Interior Trim
Cadillac & Ford Windstar
1998 - On

UNIT PACKAGE: 15



12566

(GM: 25508532;
Chry: 6032061)
Black Nylon

Grille Attaching Grommet
#6 or #8 Screw Size
GM & Chrysler 1981-On

UNIT PACKAGE: 25



19733

(22603044)
Black Nylon

Front Bumper
Fascia Grommet
Assembles With
Auveco 19732
Hinged Pin Retainer
Pontiac Grand Am
1999 - On

UNIT PACKAGE: 15



19732

(22615352)
Black Nylon

Front Bumper Fascia
Hinged Pin Retainer
Assembles With
Auveco 19733 Grommet
Pontiac Grand Am
1999 - On

UNIT PACKAGE: 15



20635
(GM: 22722860)
White Nylon

Trim Panel Grommet
With Sealer
Flange Diameter: 24mm
Stem Length: 12mm
Fits Into 9mm Hole
Use With Auveco 20634
Oldsmobile Alero &
Pontiac Grand Am
2002 - On
UNIT PACKAGE: 25



19613
(15733971)
Black Nylon

Front Air Deflector Retainer
Small Head Dia.: 18mm
Medium Head Dia.: 26mm
Flange Dia.: 30mm
Stem Length: 24mm
Use With 19614
C & K Trucks
1999 - On
UNIT PACKAGE: 15

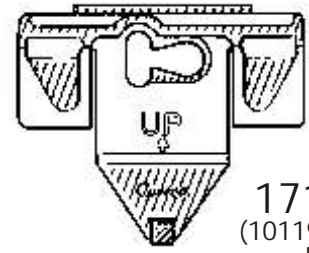

17128
(10119853)
Nylon

Body Side & End Gate Lower
Moulding Clip
Olds Custom Cruiser
1991-On
UNIT PACKAGE: 25



20527
(15745990)
Black Nylon

Rear Light Housing
Lower Grommet
Head Size: 24mm x 24mm
Stem Length: 17mm
Fits Into 15mm Hole
GM Bravada, Envoy
& Trailblazer
2002 - On
UNIT PACKAGE: 15



19614
(15733970)
Black Nylon

Front Air Deflector
Grommet
Head Dia.: 28mm
Stem Length: 13mm
Use With 19613
C & K Trucks
1999-On
UNIT PACKAGE: 25

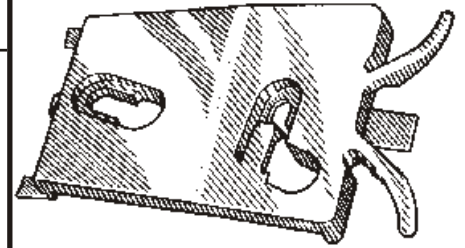

13925
(20338568)
Nylon

Outer Panel Front of Rear
Wheel Opening Moulding Clip
GM 1982-On
UNIT PACKAGE: 10



20529
(15745991)
Black Nylon

Rear Light Housing
Upper Grommet
Head Size: 13mm x 20mm
Stem Length: 17mm
Fits Into 9mm x 16mm Hole
GM Bravada, Envoy
& Trailblazer
2002 - On
UNIT PACKAGE: 15



19363
(3548693)
Nylon

Front Door
Lower Moulding Clip
Cadillac Eldorado
1992-On
UNIT PACKAGE: 10



18911
(22578985)
Nylon

Rocker Panel
Moulding Clip
Buick Skylark 1993-On
UNIT PACKAGE: 10



18977
(15690729)
Black Nylon

Front & Rear Rocker Panel
Moulding Retainer
GM Astro & Safari 1995 - On
UNIT PACKAGE: 25

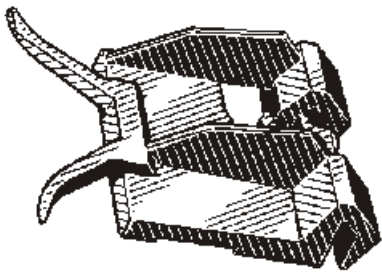

17545
(22550254)
Nylon

Rocker Panel Moulding Clip
Pontiac Grand Am SE
1992-On

UNIT PACKAGE: 25

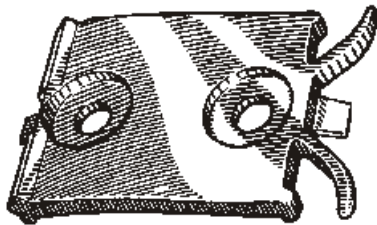

13924
(10013153)
Nylon

Rocker Panel Moulding to Fender
Clip
GM 1981-On

UNIT PACKAGE: 10



19361
(25554845)
Nylon

Rocker Panel Moulding Clip
Pontiac Bonneville
1992-On

UNIT PACKAGE: 20



19410
(10261327)
Nylon

Front & Rear Door
Lower Moulding Clip
Buick Century, Regal & Rendezvous
And Pontiac Aztek & Grand Prix
1997-On

UNIT PACKAGE: 15



11138
(6263345)
Nylon

Body Side Moulding Clip
Use w/ 1/8" Pop Rivet
GM Trucks 1968-On

UNIT PACKAGE: 10

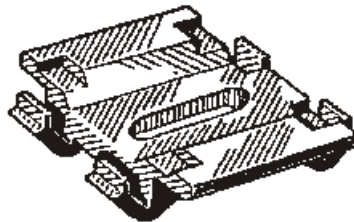

17548
(25604615)
Nylon

Door Moulding Clip
Attaches Bright Moulding
To Trim Panel On Front
And Rear Doors
Buick Park Ave.
1991-On

UNIT PACKAGE: 25

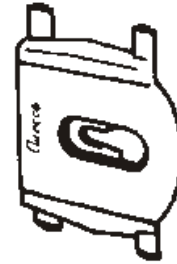

11485
(1729250)
Nylon

Roof Transverse Moulding Clip
GM 1976-On

UNIT PACKAGE: 25

For The Most
Up-To-Date
Information
On New Items
Available
From Auveco,
Refer To The
"Hot New Items"
Section
Of The Auveco
Website
(www.auveco.com)

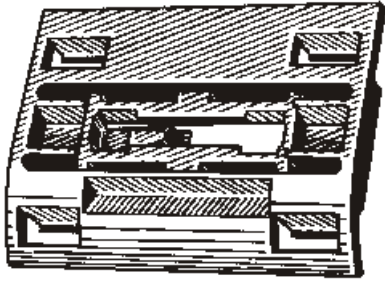

14215
(15597271)
Nylon

Body Side Moulding Clip
GM Vans 1985-On

UNIT PACKAGE: 25



11816
(20046150)
Nylon

Quarter Belt Moulding Clip
GM 1977-On

UNIT PACKAGE: 50

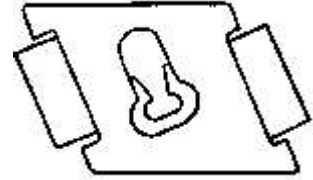

14946
(20606417)
Nylon

Left Outer Panel In Front of Rear
Wheel Opening Moulding Clip
1-3/16" Long, 7/8" Wide
Pontiac Bonneville 1989-87

UNIT PACKAGE: 25

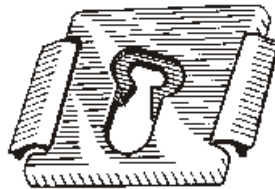

14945
(20606416)
Nylon

Right Outer Panel In Front of Rear
Wheel Opening Moulding Clip
1-3/16" Long; 7/8" Wide
Pontiac Bonneville 1989-87

UNIT PACKAGE: 25



10220
(4457595,
4457495)
Nylon

Quarter Belt & Wheel Opening
Moulding Clip
GM 1967 -On

UNIT PACKAGE: 50



11802
(20067021)
Nylon

Belt Moulding Clip
GM 1977-On

UNIT PACKAGE: 50

Inquire About Our
FastTrack Cost
Recovery Program
For Body Shops



11288
(9838109)
Gray Nylon

Body Side Moulding Clip
Buick, Chevrolet & Oldsmobile
1967-On

UNIT PACKAGE: 100



18118
(10135796)
Nylon

Body Side Moulding Clip
Buick Roadmaster
1991-On

UNIT PACKAGE: 15



9850
(7731589)
Natural Nylon

Quarter Panel Reveal Moulding &
Landau Top Moulding Clip
Use With Screw 9877
GM

UNIT PACKAGE: 100



12602
(20237057)
Nylon

Moulding Clip
GM 1980-On

UNIT PACKAGE: 25



11425
(1688094)
Nylon

Vinyl Top Clip
(Used on narrow Moulding across
top of roof)
Chevrolet, Cadillac & Oldsmobile
1974-On

UNIT PACKAGE: 50



10617
(8799350)
Nylon

Door, Quarter Panel & Rear End
Moulding Clip
GM 1970-On

UNIT PACKAGE: 50

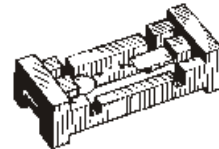

12621
(14022878)
Nylon

Moulding Clip
GM 1980-On

UNIT PACKAGE: 25



11426
(9727078)
Nylon

Belt Moulding Clip
GM

UNIT PACKAGE: 50



12563
(20175051,
15633873)
Nylon

Quarter Belt Reveal Moulding Clip
GM 1980-On

UNIT PACKAGE: 50



12613
(20315425)
Nylon

Moulding Clip
GM 1981-On

UNIT PACKAGE: 50

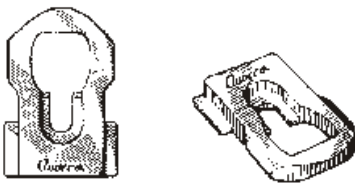

11717
(1660123)
Nylon

Belt Moulding Clip
GM 1975-On

UNIT PACKAGE: 50



12594
(20171942)
Nylon

Moulding Clip
GM 1980-On

UNIT PACKAGE: 25



14642
(20199675)
Nylon

Quarter Belt Reveal Moulding Clip
7/16" Wide, 31/32" long
GM 1980-On

UNIT PACKAGE: 50



12828
(22512114)
Nylon

Rocker Panel Moulding Clip
GM 1982-On

UNIT PACKAGE: 50

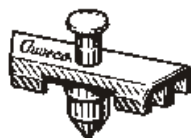

17219
(21093588)
Nylon

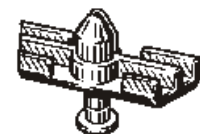

Roof Drip Moulding Clip
2 Door & 4 Door Models
GM Saturn 1991-On

UNIT PACKAGE: 25



12824
(20274997)
Nylon

Rear Quarter Reveal Moulding Clip
GM 1980-On

UNIT PACKAGE: 50



10318
(8733059
4492962, 9838109)
Nylon

Body Side & Wheel Opening Moulding Clip
Buick, Chevrolet & Oldsmobile 1968-On

UNIT PACKAGE: 100



14033
(20393536)
Nylon

Front/Side Fender Moulding Clip
GM Truck 1983-On

UNIT PACKAGE: 25



20911
(11561857)
White Nylon

Front and Rear Bumper
Moulding Clip
Width: 11mm
Length: 14mm
Buick Lacrosse & Regal,
Cadillac C & K Truck
Chevrolet C & K Truck
And GMC C & K Truck
1997 - On

UNIT PACKAGE: 25



13458
(20444103)
Nylon

Door Moulding Clip
GM 1984-On

UNIT PACKAGE: 15



20263
(22599312)
Black Nylon

Front & Rear Door
Window Moulding Clip
Chevrolet Malibu, Oldsmobile
Achieva & Cutlass
1997 - On

UNIT PACKAGE: 25



13828
(GM: 1706200)

Quarter Belt Moulding Clip
Cadillac 1976-On

UNIT PACKAGE: 25



20232
(10287926)
Yellow Nylon

Front & Rear Door
Window Moulding Clip
Overall Length: 1-9/16"
Buick Century & Regal
and Oldsmobile Intrigue
1997 - On

UNIT PACKAGE: 25

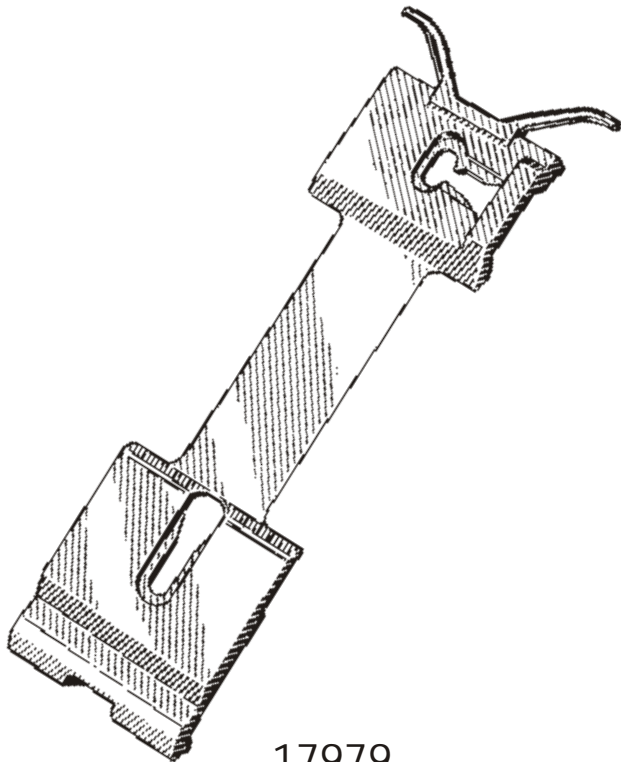

17979
(25552856)
Nylon

Front & Rear Door Center Moulding Clip
4-3/8" Long
Buick LeSabre Ltd. 1992-On

UNIT PACKAGE: 5



20578
(GM: 88970495,88973654;
Toyota: 76924-52021)
Black Nylon

Rocker Moulding Retainer
Head Diameter: 32mm
Stem Length: 10mm
Fits Into 22mm Hole
Pontiac Vibe & Toyota Corolla
2003 - On

UNIT PACKAGE: 25



18421
(25606388)
Nylon

Front & Rear Door
Lower Finish Panel Moulding Clip
Use With 18417
Pontiac Bonneville
1992-On

UNIT PACKAGE: 25



19358
(3526573)
Nylon

Front & Rear Door
Lower Moulding Clip
Cadillac DeVille & Seville
1997-92

UNIT PACKAGE: 10

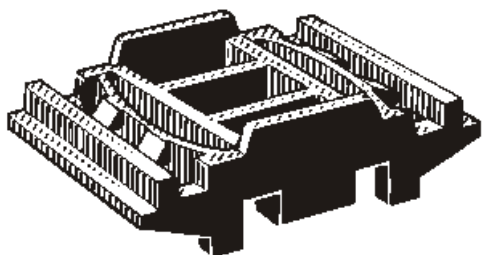

18417
(12519975)
Nylon

Front & Rear Door
Lower Finish Panel
(Lower) Moulding Clip
Use With 18421
Pontiac Bonneville
1992-On

UNIT PACKAGE: 15



18418
(16611889)
Nylon

Front Fender, Door
& Rear Quarter Panel
Center Moulding (Lower) Clip
Pontiac Grand Prix
1991-On

UNIT PACKAGE: 10

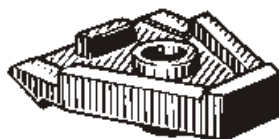

18429
(12519972)
Nylon

Rear Door
Lower Finish Panel
Upper Moulding Clip
Pontiac Bonneville
1992-On

UNIT PACKAGE: 15

"You can't find a place to save a million dollars. But there are a million places to save a dollar."

"Pop" Gale

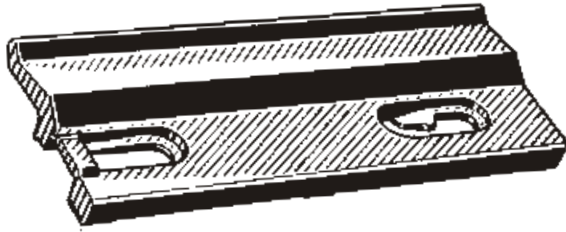

18425
(10167456,
10220975)
Nylon

Front & Rear Door
Moulding Clip
Olds Cutlass Supreme, Royale
1992-On

UNIT PACKAGE: 15

Not Actual Size



19389
(25630330)
Nylon

Front Fender and
Front & Rear Door
Upper Moulding Clip
Pontiac Bonneville
1996-On

UNIT PACKAGE: 10

Not Actual Size

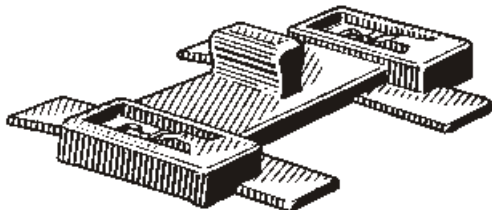

18427
(20730529)
Nylon

Front & Rear Door
Lower Finish Panel
Moulding Clip
Cadillac Seville, Olds 98
& Pontiac Bonneville
1988-On

UNIT PACKAGE: 15

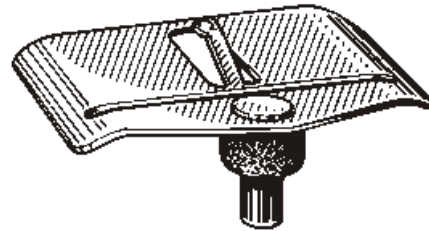

18430
(20448469)
Phosphate

Front & Rear Door
Rocker Panel
Moulding Clip
Buick Somerset Regal & Skylark
1991-85

UNIT PACKAGE: 10

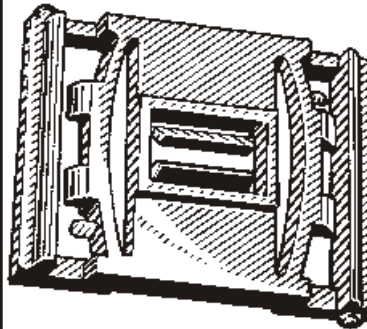

18511
(12506127)
Nylon

Front & Rear Door
Lower Moulding Clip
Buick Electra Park Ave.,
Cadillac Seville, Olds
Delta 88 Royale &
Pontiac Bonneville
1991-On

UNIT PACKAGE: 15



19411
(25630331)
Nylon

Front Door And
Front & Rear Fender
Moulding Clip
Pontiac Bonneville
1996-On

UNIT PACKAGE: 10



18428
(10167448)
Nylon

Rear Quarter Center Front
Moulding Clip
Olds Cutlass
(Exc. Deluxe Extra Trim)
1994-92

UNIT PACKAGE: 25

Not Actual Size

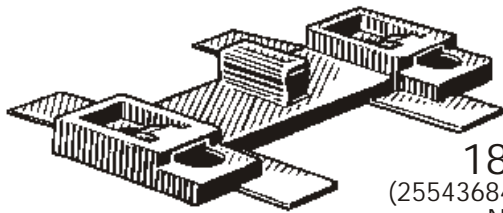

18459
(25543684, 25600989)
Nylon

Door Lower Finish
Panel Moulding Clip
Buick Park Ave., Cadillac Seville, Olds 88 Royale &
Pontiac Bonneville 1991-On

UNIT PACKAGE: 25



19370
(16615006)
Nylon

Rocker Panel Moulding Clip
Oldsmobile Aurora
1995-On

UNIT PACKAGE: 15

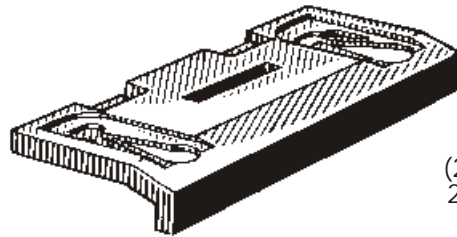

18422
(25552852,
25633289)
Nylon

Door Upper Moulding Clip
w/Deluxe Extra Trim
Pontiac Bonneville 1992-On

UNIT PACKAGE: 15

Not Actual Size



19360
(22637865)
Nylon

Rocker Panel Moulding Clip
Pontiac Grand Am
1996-On

UNIT PACKAGE: 10

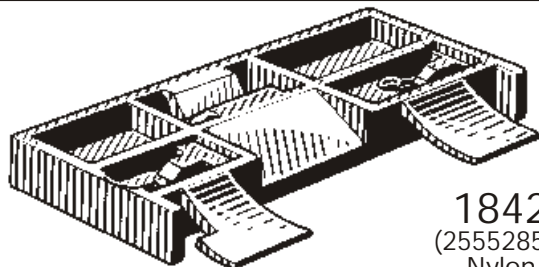

18423
(25552853)
Nylon

Door Upper Moulding Clip
Pontiac Bonneville 1992-On

UNIT PACKAGE: 15



19362
(22642199)
Nylon

Rocker Panel Moulding Clip
Oldsmobile Achieva & Cutlass
1997-On

UNIT PACKAGE: 25



19357
(10167445)
Nylon

Rocker Quarter Panel
Moulding Clip
Oldsmobile Cutlass
Supreme
1997-92

UNIT PACKAGE: 15



19412
(25630332)
Nylon

Rocker Panel
Moulding Clip
Pontiac Bonneville
1996-On

UNIT PACKAGE: 10

GENERAL MOTORS CLIPS & FASTENERS Sec. 20



20280
(25648693)
Gray Nylon

Rocker Panel
Moulding Clip
7/8" Wide
2" Long
Cadillac DeVille
& Seville
1998 - On

UNIT PACKAGE: 10



20522
(25691949, 25704001)
Black Nylon

Rocker Panel Moulding Clip
Width: 7/8", Length: 2"
Buick Park Ave.,
Cadillac DeVille & Seville
And Pontiac Bonneville
2000 - On

UNIT PACKAGE: 10



20318
(25722671)
Gray Nylon

Rocker Panel Clip
Width: 7/8"
Length: 2"
Buick LeSabre, Cadillac DeVille &
Seville, Oldsmobile Aurora and
Pontiac Bonneville
2000 - On

UNIT PACKAGE: 10



19390
(10270672)
Nylon

Rear Side Door
Lower Moulding Clip
Pontiac Trans Sport, Montana
1997-On

UNIT PACKAGE: 10



18390
(10082288)
Black Nylon

Front Door
Moulding Retainer
Chevrolet Beretta, Corsica
1987-On

UNIT PACKAGE: 25



18419
(16611887)
Nylon

Front Fender, Door
& Rear Quarter Panel
Center Moulding (Upper) Clip
Pontiac Grand Prix
1991-On

UNIT PACKAGE: 15



20408
(10287547)
White Nylon

Door & Rocker Panel
Moulding Clip
Top Head Size: 3.5mm x 8mm
Bottom Head Size: 8.7mm x 12mm
Stem Length: 8mm
Fits Into 8mm Hole
Buick Century, Regal &
Pontiac Grand Prix
1995 - On

UNIT PACKAGE: 25



19757
(10431524)
Black Nylon

Rocker Panel
Moulding Clip
Head Size: 11/16" x 1-5/16"
Stem Length: 9/16"
Snaps Into 5/16" Hole
Chevrolet Impala, Lumina
& Monte Carlo
2000 - On

UNIT PACKAGE: 15



18420
(16611888)
Nylon

Front Fender, Door
& Rear Quarter Panel
Center Moulding (Lower) Clip
Pontiac Grand Prix
1991-On

UNIT PACKAGE: 15



15695
(Toyota: 62955-20020;
GM: 94848834)
Nylon

Retainer With Sealer
Head Dia: 15mm
Stem Length: 9mm
Fits Into 8mm Hole
Toyota Pick-Up Truck
Pontiac Vibe

UNIT PACKAGE: 25



20326
(25718851)
Yellow Nylon

Door Trim Moulding Clip
Head Size: 9/16" x 3/4"
Stem Length: 3/8"
Cadillac DeVille & Seville
1998 - On

UNIT PACKAGE: 25





19800
(10437565)
Black Nylon

Rocker Panel
Moulding Clip
Head Size: 15/32" x 1-5/16"
Stem Length: 9/16"
Snaps Into 5/16" Hole
Chevrolet Impala,
Lumina & Monte Carlo
2000 - On

UNIT PACKAGE: 10



20809
(10352797)
Gray Nylon

Rocker Panel
Moulding Clip
Head Size: 11/16" x 1-5/16"
Stem Length: 11/16"
Fits Into 5/16" Hole
Chevrolet Impala, Lumina
& Monte Carlo
2000 - On

UNIT PACKAGE: 15



20975
(10353834)
Red Nylon

Rocker Panel Moulding Clip
Head Size: 15/32" x 1-9/32"
Stem Length: 11/16"
Fits Into 5/16" Hole
Chevrolet Impala, Lumina
& Monte Carlo
2000 - On

UNIT PACKAGE: 10



20810
(10431523)
Tan Nylon

Rocker Panel
Moulding Clip
Head Size: 11/16" x 1-5/16"
Stem Length: 9/16"
Fits Into 5/16" Hole
Chevrolet Impala, Lumina
& Monte Carlo
2000 - On

UNIT PACKAGE: 15



20808
(10352799)
Black Nylon

Rocker Panel
Moulding Clip
Head Size: 11/16" x 1-5/16"
Stem Length: 11/16"
Fits Into 5/16" Hole
Chevrolet Impala, Lumina
& Monte Carlo
2000 - On

UNIT PACKAGE: 15



20520
(10308063)
Black Nylon

Rocker Panel Moulding Clip
Head Size: 18mm x 35mm
Stem Length: 20mm
Fits Into 10mm Hole
Buick Rendezvous &
Pontiac Aztek
2001 - On

UNIT PACKAGE: 15



20811
(10431526)
Red Nylon

Rocker Panel
Moulding Clip
Head Size: 11/16" x 1-5/16"
Stem Length: 9/16"
Fits Into 5/16" Hole
Chevrolet Impala, Lumina
& Monte Carlo
2000 - On

UNIT PACKAGE: 15



20973
(10352798)
Tan Nylon

Rocker Panel Moulding Clip
Head Size: 11/16" x 1-5/16"
Stem Length: 11/16"
Fits Into 5/16" Hole
Chevrolet Impala, Lumina
& Monte Carlo
2000 - On

UNIT PACKAGE: 15



20976
(25742293)
Blue Nylon

Rocker Panel Moulding Clip
Top Head Size: 9/16" x 25/32"
Bottom Head Size: 5/8" x 25/32"
Stem Length: 9/16"
Fits Into 3/8" Hole
Cadillac DeVille & Seville
2000 - On

UNIT PACKAGE: 15



20775
(10352809)
White Nylon

Rocker Panel Moulding Clip
Head Size: 11/16" x 1-5/16"
Stem Length: 11/16"
Fits Into 5/16" Hole
Chevrolet Impala, Lumina &
Monte Carlo
2000 - On

UNIT PACKAGE: 15



20974
(10352804)
Maroon Nylon

Rocker Panel Moulding Clip
Head Size: 15/32" x 1-9/32"
Stem Length: 11/16"
Fits Into 5/16" Hole
Chevrolet Impala, Lumina
& Monte Carlo
2000 - On

UNIT PACKAGE: 10



20972
(11589176)
White Nylon

Rocker Panel Moulding Clip
Top Head Size: 3/4" x 1-1/32"
Bottom Head Size: 19/32" x 1-1/32"
Stem Length: 9/16"
Fits Into 3/8" Hole
Chevrolet Malibu
2004 - On

UNIT PACKAGE: 15

GENERAL MOTORS CLIPS & FASTENERS Sec. 20



20865
(15221959)
Gray Nylon

Rocker Panel Moulding Clip
Width: 9/16"
Length: 1-1/8"
Stem Length: 9/16"
Fits Into 1/2" Hole
Chevrolet Cobalt & HHR
2005 - On

UNIT PACKAGE: 15



19820
(22603384)
White Nylon

Rocker Panel Moulding Clip
Head Size: 3/4" x 1-3/16"
Stem Length: 19/32"
Fits Into 7/16" Hole
Oldsmobile Alero
& Pontiac Grand Am
1999 - On

UNIT PACKAGE: 15



20607
(10323057)
White Nylon

Rocker Moulding Clip
Top Head Size: 12mm x 20mm
Stem Length: 14mm
Fits Into 9mm Hole
Pontiac Grand Prix
2004 - On

UNIT PACKAGE: 15



20952
(15236894)
White Nylon

Rocker Panel Moulding Clip
Top Head Size: 9/16" x 23/32"
Overall Height: 5/8"
Stem Length: 7/16"
Fits Into 3/8" Hole,
Buick Lucerne and
Cadillac CTS & STS
2003 - On

UNIT PACKAGE: 15



20377
(11518357)
White Nylon

Rocker Panel Moulding Clip
With Sealer
Top Head Size: 9/16" x 13/16"
Bottom Head Size: 13/16" x 13/16"
Stem Length: 9/16"
Fits Into 7/16" Hole
Chevrolet Avalanche
2002 - On

UNIT PACKAGE: 15



20417
(91176726)
White Nylon

Side Door, Wheel Opening
& Rocker Panel
Moulding Clip With Sealer
Top Head Size: 15/32" x 25/32"
Bottom Head Size: 9/16" x 25/32"
Stem Length: 7/16"
Fits Into 7/16" Hole
Geo Tracker 2001 - On

UNIT PACKAGE: 15



20328
(10443956)
White Nylon

Rocker Panel Moulding Clip
Top Head Size: 9/16" x 13/16"
Bottom Head Size: 13/16" x 13/16"
Stem Length: 9/16"
Fits Into 7/16" Hole
Chevrolet Impala, Lumina,
Monte Carlo and C & K Trucks
2000 - On

UNIT PACKAGE: 15



19822
(25693852)
Gray Nylon

Rocker Panel Moulding Clip
Top Head: 9/16" x 3/4"
Bottom Head: 5/8" x 3/4"
Stem Length: 9/16"
Fits Into 7/16" Hole
Buick LeSabre; Cadillac Concours,
DeVille, Eldorado & Seville;
Chevrolet Impala, Lumina & Monte
Carlo; Oldsmobile Aurora and
Pontiac Bonneville
1995 - On

UNIT PACKAGE: 25



20885
(15288146,
15893516)
Gray Nylon

Windshield Pillar
Moulding Clip
Top Head Size: 12mm x 20mm
Bottom Head Size: 14mm x 20mm
Stem Length: 15mm
Fits Into 9mm Hole
Chevrolet Equinox &
Pontiac Torrent
2005 - On

UNIT PACKAGE: 15



20774
(25724529)
White Nylon

Rocker Moulding & Grille
Moulding Clip
Top Head Size: 9/16" x 13/16"
Bottom Head Size: 5/8" x 13/16"
Stem Length: 9/16"
Fits Into 3/8" Hole
Buick LeSabre & Rainier;
Cadillac Concours, CTS,
DeVille, Eldorado, Escalade,
Seville, SRX & STS; Chevrolet
Avalanche, Impala, Lumina,
Monte Carlo, SSR,
Vans & Trucks; Oldsmobile
Aurora & Bravada
and Pontiac Bonneville
1992 - On

UNIT PACKAGE: 15



20756
(5480852)
Yellow Nylon

Rocker Panel Moulding Clip
With Sealer
Top Head Size: 9/16" x 25/32"
Bottom Head Size: 5/8" x 13/16"
Stem Length: 9/16"
Chevrolet Equinox
2005 - On

UNIT PACKAGE: 10

Sec. 20**GENERAL MOTORS CLIPS & FASTENERS****20934**
(15127746)
White NylonBody Side Moulding Clip
Head Size: 12mm x 20mm
Stem Length: 11mm
Fits Into 9mm Hole
Buick Terraza, Chevrolet Uplander,
GMC Arcadia, Pontiac
Montana SV6 And
Saturn Relay
2005 - On

UNIT PACKAGE: 15

**20617**
(10242602)
Green NylonWheel Opening
Moulding Clip
Top Head Size: 9/16" x 13/16"
Bottom Head Size: 9/16" x 13/16"
Stem Length: 1/2"
Fits Into 7/16" Hole
Pontiac Trans Sport/ Montana
1997 - On

UNIT PACKAGE: 10

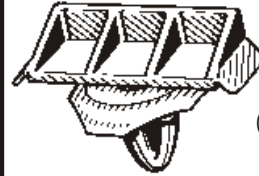
**18274**
(16614134)
NylonFront Fender &
Door Moulding Clip
Olds Cutlass Supreme
4 Door
1992 - On

UNIT PACKAGE: 25

**20481**
(10423553)
Green NylonSide Moulding, Fender &
Rocker Panel Moulding Clip
Top Head Size: 1/2" x 13/16"
Bottom Head Size: 19/32" x 13/16"
Stem Length: 9/16"
Fits Into 7/16" Hole
Pontiac Aztek And
GM C & K Trucks
2001 - On

UNIT PACKAGE: 15

**19381**
(10297368)
White NylonRear Wheel Opening
Moulding Clip
Top Head Size: 15/32" x 25/32"
Bottom Head Size: 1/2" x 25/32"
Stem Length: 9/16"
Fits Into 7/16" Hole
Pontiac Trans Sport, Montana
With Short Wheel Base
1997 - On

UNIT PACKAGE: 10

**20935**
(15116576,
15282120)
Green NylonBody Side Moulding Clip
Head Size: 16mm x 38mm
Stem Length: 15mm
Fits Into 10mm Hole
Buick Terraza, Cadillac C & K Truck,
Chevrolet C, K Truck & Uplander,
GMC Arcadia, C & K Truck,
Pontiac Montana SV6
And Saturn Relay
2005 - On

UNIT PACKAGE: 15

**20521**
(10242285, 10308019, 10297369)
Black Nylon With SealerRocker Panel Moulding Clip
Top Head Size: 15/32" x 25/32"
Bottom Head Size: 5/8" x 25/32"
Stem Length: 9/16"
Fits Into 7/16" Hole
Pontiac Aztek, Montana
& Trans Sport
1997 - On

UNIT PACKAGE: 15

**19379**
(10297371)
Yellow NylonRear Wheel Opening
Moulding Clip
Top Head Size: 19/32" x 25/32"
Stem Length: 9/16"
Fits Into 7/16" Hole
Pontiac Trans Sport, Montana
With Long Wheel Base
1997 - On

UNIT PACKAGE: 15

**21036**
(11518988)
White NylonFender, Spoiler & Roof Rack
Moulding Clip With Sealer
Top Head: 12mm x 21mm
Bottom Head: 12mm x 20mm
Stem Length: 15mm
Fits Into 9mm Hole
Buick Enclave, Chevrolet SSR, GMC
Acadia, Hummer H3, S & T Trucks
2002 - On

UNIT PACKAGE: 15

**20353**
(10442914)
White NylonRocker Panel Moulding Clip
Top Head Size: 1/2" x 9/16"
Bottom Head Size: 9/16" x 5/8"
Stem Length: 9/16"
Fits Into 7/16" Hole
Buick Rendezvous
2002 - On

UNIT PACKAGE: 15

**20825**
(10297370)
Brown NylonMoulding Clip
With Sealer
Top Head Size: 12mm x 20mm
Bottom Head Size: 15mm x 20mm
Stem Length: 14mm
Fits Into 11mm Hole
Chevrolet Venture,
Oldsmobile Silhouette,
Pontiac Trans Sport
APV & Montana
And Hummer
1997 - On

UNIT PACKAGE: 15

**21013**
Not Available
From O.E.M.
Yellow NylonRocker Panel
Moulding Clip
Top Head Size: 15/32" x 13/16"
Bottom Head Size:
15/32" x 25/32"
Stem Length: 9/16"
Fits Into 3/8" Hole
Hummer H3
2005 - On

UNIT PACKAGE: 15

GENERAL MOTORS CLIPS & FASTENERS Sec. 20



20951
(15236893)
Black Nylon

Rocker Panel Moulding Clip
Top Head Size: 3/4" x 1-9/16"
Overall Height: 11/16"
Stem Length: 7/16"
Fits Into 3/8" Hole
Buick Lucerne
2006 - On

UNIT PACKAGE: 15



20868
(11589182)
Black Nylon

Rocker Panel Moulding Clip
With Sealer
Head Size: 11/16" x 2-3/16"
Stem Length: 11/16"
Fits Into 5/8" Hole
Hummer
2006 - On

UNIT PACKAGE: 10



20950
(10384814)
White Nylon

Rocker Panel Moulding Clip
Top Head Size: 3/4" x 1-9/16"
Overall Height: 1-7/16"
Stem Length: 21/32"
Fits Into 7/16" Hole
Buick Lucerne
2006 - On

UNIT PACKAGE: 15



18833
(3531990)
Nylon

Rocker Panel
Push-Type
Moulding Clip
Cadillac Seville &
Touring Sedan
1994-On

UNIT PACKAGE: 5



20884
(11561491,
15872008)
Black Nylon

Rocker Panel
Moulding Clip
With Sealer
Top Head: 20mm x 30mm
Overall Length: 28mm
Fits Into 17mm Hole
Chevrolet Equinox &
Pontiac Torrent
2005 - On

UNIT PACKAGE: 10



20464
(10270517)
White Nylon

Rocker Panel &
Fender Flare
Moulding Clip
Overall Length: 41mm
Stem Length: 13mm
Fits Into 12mm Hole
Pontiac Trans Sport &
Montana
1997 - On

UNIT PACKAGE: 5



19008
(16616138)
Black Nylon

Rocker Panel Moulding Clip
Cavalier & Sunfire
1995-On

UNIT PACKAGE: 25



19821
(10431761)
Gray Nylon

Rocker Panel Moulding Clip
Top Head Size: 11/16" x 1-1/2"
Bottom Head Size: 7/8 x 1-9/16"
Stem Length: 1-1/4"
Fits Into 7/16" Hole
Chevrolet Impala,
Lumina & Monte Carlo
2000 - On

UNIT PACKAGE: 15



20891
(11589244,
11569973)
Yellow Nylon

Rocker Panel
Moulding Clip With Sealer
Top Head Size: 15/32" x 27/32"
Bottom Head Size:
15/32" x 25/32"
Stem Length: 1-3/8"
Fits Into 7/16" Hole
Chevrolet Equinox,
Pontiac Torrent And Trucks
2005 - On

UNIT PACKAGE: 10

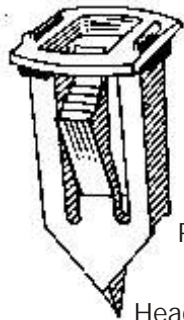

11118
(9617200)
Nylon

Roof, Inner Side
Front, Rear &
Panel
Headlining Clip
GM 1973-On

UNIT PACKAGE: 10

11119

Same as 11118 except packing

UNIT PACKAGE: 100

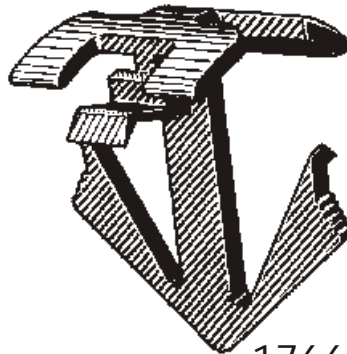

17666
(20632190)
Nylon

Garnish Moulding Clip
Back Window Upper &
Side Moulding Garnish
Buick LeSabre, Cadillac Fleetwood
Brougham, Chevrolet Caprice &
Impala, Olds Delta 88 & 98,
Pontiac Bonneville & Parisienne
1989-80

UNIT PACKAGE: 10

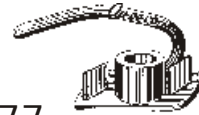

9477
(4490167)
Nylon

Tailgate Belt Moulding Fastener
Chevrolet El Camino

UNIT PACKAGE: 50



17233
(9662548)
Nylon

Headlining Wire Retainer Clip
Also Panel To Rear Bumper
Filler Clip
GM 1990-73

UNIT PACKAGE: 50



18398
(20058837)
Nylon

Windshield Upper Garnish
Moulding Clip
GM A & G Models
1988-78

UNIT PACKAGE: 10



18399
(20095324)
Nylon

Back Window Upper Garnish
Moulding Clip
GM (Except Cadillac) 1988-78

UNIT PACKAGE: 10



9965
(3944866, 1244839)

Universal Moulding Fastener
GM

UNIT PACKAGE: 25

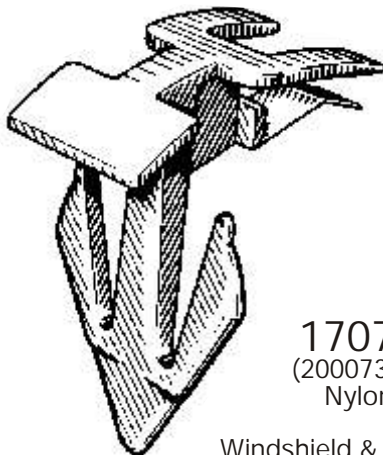

17074
(20007308)
Nylon

Windshield &
Back Window
Garnish Clip
Buick Electra & LeSabre;
Cadillac DeVille & Fleetwood;
Chevrolet Caprice & Impala;
Oldsmobile 88 & 98 and
Pontiac Bonneville 1984-77

UNIT PACKAGE: 25



16865
(20462090)
Nylon

Garnish Moulding Clip
Buick Century & Regal, Chevrolet
Camaro, Celebrity, Monte Carlo &
Malibu, Oldsmobile Cutlass & Ciera,
Pontiac Firebird Grand Prix & 6000
1978-On

UNIT PACKAGE: 25



2943
(4759145,
4761842,
4779348)

Front and Rear Fender and Door
Peak Moulding Fastener
GM

UNIT PACKAGE: 15

12966

Same as 2943 except packing

UNIT PACKAGE: 15



19602

Chevrolet Grille Bolt Kit
For installing and attaching Grille on
Chevrolet Cars.
Consists of: 50 pcs. 10-24 x 1/2"
Machine Screws
50 pcs. 10-24 Keps Nuts

UNIT PACKAGE: 50 Sets



20892
(12337831)
Black Nylon

Front Bumper
Push-Type Retainer
Head Size: 14mm x 26mm
Stem Length: 14mm
Fits Into 8mm Hole
Pontiac G6
2005 - On

UNIT PACKAGE: 50



19335
(22659122)
Black Nylon

Front Bumper Fascia
Push-Type Retainer
Head Size: 1-1/8" x 1-3/4"
Stem Length: 15/16"
Fits Into 1/2" Hole
Chevy Malibu, Olds Achieva
& Cutlass
1997 - On

UNIT PACKAGE: 10



14013
(GM: 20475949;
VW: 175-853-673)
Black Nylon

Air Vent Screw
Use With 14014

UNIT PACKAGE: 50



19433
(25618359)
Black Nylon

Front Bumper Fascia
Push-Type Retainer
Head Size: 15/32" x 7/8"
Stem Length: 15/32"
Fits Into 9/32" Hole
Buick Park Ave.
1996-92

UNIT PACKAGE: 25



14953
(GM: 15679091;
Ford: N803494S)
Black Nylon

Fascia, Trim & Grille Retainer
Head Size: 15/32" x 15/32"
Stem Length: 21/32"
Fits Into 1/4" Square
Hole or Slot
GM 1994 - On
Ford 1985 - On

UNIT PACKAGE: 25



14001
(14039420)
Black Nylon

Push-Type Retainer
Head Dia: 21/32"
Stem Length: 19/32"
Fits Into 5/16" Hole
GM (Including Saturn)

UNIT PACKAGE: 25



14008
(14032200)
Black Nylon

Grille Attachment
Retainer
Head Size:
3/4" x 19/32"
Stem Length: 19/32"
Fits Into 5/16" Hole
GM 1981-On

UNIT PACKAGE: 25

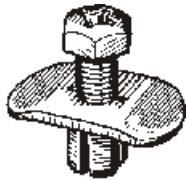

14727
(GM: 94221150;
Nissan: 63844-00100)
Black Nylon

Push-Type Retainer
Head Size: 14mm x 22mm
Stem Length: 9mm
Fits Into 7mm Hole
Geo Storm 1990-On

UNIT PACKAGE: 25



14697
(GM: 94198687;
Honda: 90657-SA6-0030;
Mazda: N304-13-356-A)
Black Nylon

Push-Type Retainer
Head Dia: 14mm
Stem Length: 11mm
Fits Into 7mm Hole

UNIT PACKAGE: 25

Looking For A New
Fastener That's Not In The
Auveco Catalog?
Send Us An E-Mail
About It.
mail@auveco.com



19726
(94858343)
Black Nylon

Door Trim Panel
Push-Type Retainer
Head Diameter: 14mm
Stem Length: 8mm
Fits Into 6mm Hole
Geo Prizm
1998-On

UNIT PACKAGE: 15



13457
(20451119)
Black Nylon

Front Compartment
Spare Tire Retainer
Head Diameter: 43/64"
Stem Length: 23/32"
Fits Into 5/16" Hole
GM

UNIT PACKAGE: 10



17214
(GM: 10089262,
21042098;
Chry: 55075139)
Black Nylon

Push-Type Retainer
Head Dia: 11mm (7/16")
Stem Length: 18mm (11/16")
Fits Into 6mm (15/64") Hole
GM & Saturn 4 Door
& Station Wagon
1987-On

UNIT PACKAGE: 25



19645
(94858864)
Gray Nylon

Door Trim Panel
Push-Type Retainer
Head Diameter: 14mm
Stem Length: 8mm
Fits Into 6mm Hole
Geo Prizm
1998 - On

UNIT PACKAGE: 15



20577
(GM: 88970494,
88973676;
Toyota:
90467-07168)
Black Nylon

Rocker Panel & Garnish Moulding
Push-Type Retainer
Head Diameter: 20mm
Stem Length: 8mm
Fits Into 7mm Hole
Pontiac Vibe 2003 - On
Lexus & Toyota
2000 - On

UNIT PACKAGE: 15

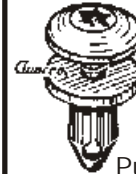

14990
(22538102)
Black Nylon

Push-Type Retainer
Head Diameter: 7/16"
Stem Length: 15/32"
Fits Into 15/64" Hole
GM 1987 - On

UNIT PACKAGE: 50



14260
(Toyota: 90467-06017;
Mazda: 9926-50-625;
GM: 20426301)
Black Nylon

Push-Type Retainer
Head Diameter: 15mm
Stem Length: 12mm
Fits Into 7mm Hole

UNIT PACKAGE: 15

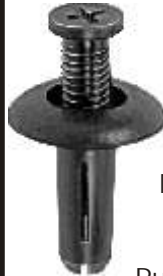

19140
(Acura:
90505-SL0-003;
GM: 94852368;
Mitsubishi:
MB888869; Toyota:
90467-08155)
Black Nylon

Push-Type Retainer
Head Diameter: 20mm
Stem Length: 21mm
Fits Into 8mm Hole
Acura, Dodge Avenger,
Eagle Talon, Geo Prizm
Mitsubishi Eclipse & Galant
and Toyota
1993-On

UNIT PACKAGE: 5



19788
(10246149; 22657634)
Black Nylon

Rocker Panel
Push-Type Retainer
Head Diameter: 11mm
Stem Length: 20mm
Fits Into 6mm Hole
Achieva, Cutlass,
Grand Am & Malibu
1999 - On

UNIT PACKAGE: 25



19243
(GM: 30008324;
Suzuki: 09409-07325)
Black Nylon

Push-Type Retainer
Head Diameter: 16mm
Stem Length: 10mm
(Not Including The Pin)
Fits Into 9mm Hole
Front & Rear Bumper Fascia
Geo Metro 1989-On
Radiator Grille
Suzuki Esteem 1995-On

UNIT PACKAGE: 15



19242
(15672149)
Black Nylon

Air Inlet Grille Panel
Push-Type Retainer
Head Dia. 13/32"
Stem Length: 11/16"
Fits Into 7/32" Hole
GM Jimmy, Blazer, S-10
& Bravada
1994-On

UNIT PACKAGE: 25



19787
(22657634)
Black Nylon

Fender & Rocker Panel
Push-Type Retainer
Head Diameter: 12mm
Stem Length: 17mm
Fits Into 6mm Hole
Achieva, Cutlass,
Grand Am & Malibu
1999 - On

UNIT PACKAGE: 25

GENERAL MOTORS CLIPS & FASTENERS Sec. 20



14995

(GM: 10195515,
Ford: N805026S;
Chrys: 4696488,
6503163)
Black Nylon

Push-Type Retainer
Head Diameter: 1/2"
Stem Length: 1-13/64"
Fits Into 9/32" Hole
GM, Ford & Chrysler
1987 - On

UNIT PACKAGE: 25



16859

(Nissan: 66860-01W01;
GM: 94051993)
Black Nylon

Cowl Panel To
Reinforcement Plate & Engine
Splash Shield Retainer
Head Dia: 14mm (9/16")
Stem Length: 16mm (5/8")
Fits Into 6mm (1/4") Hole
Nissan 1980-On
Geo Storm 1990-On

UNIT PACKAGE: 25



20943

(15014352)
Black Nylon

Cowl Vent
Push-Type Retainer
Head Diameter: 14mm
Stem Length: 23mm
Fits Into 7mm Hole
Buick Lucerne
2006 - On

UNIT PACKAGE: 15



21112

(94530438)
Black Nylon

Fender Liner
Push-Type Retainer
Head Diameter: 15mm
Stem Length: 14mm
Fits Into 6mm Hole
Chevrolet Aveo
2004 - On

UNIT PACKAGE: 25



14997

(10053182)
Black Nylon

Push-Type Retainer
Head Diameter: 19/32"
Stem Length: 13/16"
Fits Into 5/16" Hole
GM 1987 - On

UNIT PACKAGE: 25



14991

(GM: 10139822;
25680782;
Ford: N808147S)
Black Nylon

Push-Type Retainer
Head Diameter: 11/16"
Stem Length: 11/16"
Fits Into 1/4" Hole
GM & Ford 1987 - On

UNIT PACKAGE: 25



14753

(GM: 15773445, 20452072,
20664092;
Ford: N804570S;
Chrys: 4638136)
Black Nylon

Radiator Shroud &
Trim Retainer
Head Dia: 11/16"
Stem Length: 7/8"
Fits Into 1/4" Hole
GM 1982-On
Ford 1986-On
Chrysler 1998 - On

UNIT PACKAGE: 25



14993

(22538004)
Black Nylon

Push-Type Retainer
Head Diameter: 11/16"
Stem Length: 7/8"
Fits Into 1/4" Hole
GM 1987 - On

UNIT PACKAGE: 25

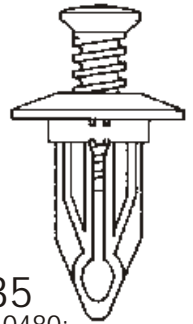

16835

(GM: 10140480;
Chry: 6502625)
Black Nylon

Rear Bumper
Fascia Retainer
Head Dia: 21mm (27/32")
Shoulder Length: 3mm (1/8")
Stem Length: 25mm (1")
Fits Into 12mm (1/2") Hole
APV Vans 1990-On

UNIT PACKAGE: 25



14998

(15672330,
15956470)
Black Nylon

Push-Type Retainer
Head Diameter: 27/32"
Stem Length: 1"
Fits Into 13/32" Hole
GM 1987 - On

UNIT PACKAGE: 25



20265

(25663903)
Black Nylon

Radiator Support Sight Shield
Push-Type Retainer
Head Diameter: 1"
Stem Length: 1"
Fits Into 1/4" Hole
Cadillac DeVille & Seville
1998 - On

UNIT PACKAGE: 10



17227
(21077405)
Black Nylon

Door Handle To Door Hardware Attachment
Push-Type Retainer
Head Diameter: 7mm
Stem Length: 10mm
Fits Into 5mm Hole
2 Door & 4 Door Models
GM Saturn 1991-On
UNIT PACKAGE: 25



20666
(22677979, 22677980)
Gray Nylon

Door Trim
Push-Type Retainer
Head Diameter: 12mm
Stem Length: 14mm (Exc. Pin)
Fits Into 6mm Hole
Chevrolet Malibu
2004 - On
UNIT PACKAGE: 25



19892
(25695687)
Black Nylon

Radiator Support
Sight Shield
Push-Type Retainer
Head Diameter: 27mm
Shoulder Length: 7mm
Stem Length: 18mm
Fits Into 10mm Hole
Cadillac DeVille & Seville
2000 - On
UNIT PACKAGE: 15



17383
(96057847)
Black Nylon

Radiator Grille & Trim Panel
Push-Type Retainer
Head Diameter: 11mm
Stem Length: 14mm
Fits Into 7mm Hole
Geo Tracker & Prizm
1992-89
UNIT PACKAGE: 10

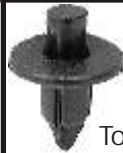

17162
(GM: 96057846;
Toyota: 90467-07041)
Black Nylon

Push-Type Retainer
Head Diameter: 15mm
Stem Length: 13mm
Fits Into 6.3mm Hole
Geo Metro & Tracker
1989-On
UNIT PACKAGE: 10



14011
(14019226,
14071289)
Black Nylon

Radiator Overflow
Bottle/Windshield
Washer Bottle Retainer
Head Dia: 21/32"
Stem Length: 9/16"
Fits Into 5/16" Hole
GM 1981-On
UNIT PACKAGE: 25

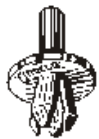

11854
(14005089)
Natural Nylon

Air Conditioning Vent & General Purpose Push-Type Retainer
Head Diameter: 7/16"
Stem Length: 9/32"
Fits Into 3/16" Hole
GM 1979 - On
UNIT PACKAGE: 25



19297
(21035345)
Black Nylon

Liftgate Upper Window & Lower Garnish Moulding
Push-Type Retainer
Head Diameter: 16mm
Stem Length: (Exc. Pin): 12mm
Fits Into 7mm Hole
GM Saturn 1998 - 93
UNIT PACKAGE: 15



12567
(GM: 14019205,
14019206, 16514113;
Chry: 34201621, 6504090)
Black Nylon

Front Fender Mud Skirt & Fender Liner
Push-Type Retainer
Head Dia: 11/16"
Stem Length: 9/16"
Fits Into 1/4" Hole
GM 1981 - On
UNIT PACKAGE: 25



18933
(15676045)
Black Nylon

Rear Window Wiper Motor Cover & Dash Board
Push-Type Retainer
Head Diameter: 7/16"
Stem Length: 1/2"
Fits Into 1/4" Hole
GM Trucks C & K, 1, 2
1991 - On
UNIT PACKAGE: 25



11699
(GM: 472434;
Chry: 6031390)
Black Nylon

Cowl Ledge Weatherstrip & Fender Liner
Push-Type Retainer
Head Dia: 11/16"
Stem Length: 5/8"
Fits Into 1/4" Hole
GM 1970-On
Chrysler 1968-On
UNIT PACKAGE: 50

14007
Same As 12567 Except Packing
UNIT PACKAGE: 50

Visit The Auveco
Web Site At
www.auveco.com

GENERAL MOTORS CLIPS & FASTENERS Sec. 20



19847
(5973823)
Blue Nylon

Fascia Retainer
Head Dia: 7/8"
Shoulder Length: 5/32"
Stem Length: 25/32"
Fits Into 1/2" Hole
GM 1979-On

UNIT PACKAGE: 25



12756
(5973996)
Brown Nylon

Fascia Retainer
Head Dia: 1"
Shoulder Length: 1/4"
Stem Length: 7/8"
Fits Into 1/2" Hole
GM: 1982-On

UNIT PACKAGE: 15



19522
(22644361)
Black Nylon

Door Sill Trim Plate
Push-Type Retainer
Head Diameter: 12mm
Stem Length: 18mm
Fits Into 6mm Square Hole
Chev. Malibu, Olds Achieva &
Cutlass
1997 - On

UNIT PACKAGE: 15



14010
(14045480)
Black Nylon

Fascia Retainer
Head Dia: 1"
Stem Length: 23/32"
Fits Into 3/8" Hole
GM 1982-On

UNIT PACKAGE: 25



19854
(21097229)
Black Nylon

Door Handle
Push-Type Retainer
Head Diameter: 7mm
Stem Length: 10mm
Fits Into 5mm Hole
Saturn 2 Door & 4 Door
1999 - On

UNIT PACKAGE: 25



17106
(GM: 22566221;
Chry: 6501577)
Black Nylon

Headlight Door Push-Type Retainer
Large Head Dia: 1/2"
Stem Length: 7/16"
Fits Into 3/16" Hole
GM Blazer & Suburban 1991 - On
Chrysler New Yorker
Landau & 5th Avenue 1988 - On

UNIT PACKAGE: 50



12757
(5973400)
Black Nylon

Fascia Retainer
Head Dia: 1"
Shoulder Length: 1/8"
Stem Length: 3/4"
Fits Into 1/2" Hole
GM 1979-On

UNIT PACKAGE: 15

16265

Same as 12757 except packing

UNIT PACKAGE: 50



14016
(GM: 16500308;
Chry: 6500787)
Black Nylon

Tail Light Retainer
Large Head Diameter: 3/8"
Stem Length: 7/16"
Fits Into 3/16" Hole
GM & Chrysler

UNIT PACKAGE: 25



19355
(15960621)
Black Nylon

Rear Door
Radio Speaker
Push-Type Retainer
Head Diameter: 17/32"
Stem Length: 1-5/64"
Fits Into 1/4" Hole
GM Trucks C & K 1, 2
1995 - On

UNIT PACKAGE: 25



13999
(20363491)
Black Nylon

Body Side Moulding
Push-Type Retainer
Large Head Diameter: 3/8"
Stem Length: 1/2"
Fits Into 7/32" Hole
GM 1979-On

UNIT PACKAGE: 25



16816
(21047094)
Black Nylon

Push-Type Retainer
Large Head Dia: 14mm
Stem Length: 14mm
Fits Into 6mm Hole
GM Saturn 1991 - On

UNIT PACKAGE: 25



17222

(GM: 11561878, 21075686;
Ford: F3LY-14570-B)
Black Nylon

Push-Type Retainer
Head Diameter: 15mm
Stem Length: 20mm
Fits Into 8mm Hole
Rocker Panel, Wheel Liner
& Air Inlet Duct Applications
GM Saturn
2 Door & 4 Door Models
1991-On
Ford

UNIT PACKAGE: 25



19801

(21077123)
Black Nylon

Wheel Opening Moulding
Push-Type Retainer
Head Diameter: 19/32" (15mm)
Stem Length: 3/4" (19mm)
Fits Into 1/4" (8mm) Hole
Saturn
1991 - On

UNIT PACKAGE: 25

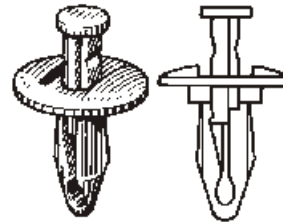

16624

(1636632, 20687704)
Black Nylon

Front Bumper
Fascia Retainer
Head Dia: 17mm
Shoulder Length: 2mm
Stem Length: 18mm
Fits Into 9.5mm (3/8") Hole
Buick Riviera/Reatta 1988-On

UNIT PACKAGE: 25



17103

(GM: 15681408;
Ford: N803709S)
Black Nylon

Fascia Retainer
Head Dia: 15mm
Stem Length: 23mm
Fits Into 6mm Hole
GM & Ford 1986-On

UNIT PACKAGE: 50



20542

(15994165)
Black Nylon

Bumper & Rear
Wheel Apron
Push-Type Retainer
Head Diameter: 16.5mm
Stem Length: 27mm
Fits Into 8mm Hole
Saturn L Series
2000 - On

UNIT PACKAGE: 25



18030

(Chry: 6501925;
GM: 10134407)
Black Nylon

Push-Type Retainer
Head Size: 11/16"
Stem Length: 13/16"
Fits Into 1/4" Hole
Chrysler Concorde & LHS
Dodge Intrepid & Eagle Vision
1993-On
Coolant Recovery Reservoir
GM 1992-On

UNIT PACKAGE: 25



17226

(10207146, 21077323)
Black Nylon

Rear Door Rocker Panel
To Underbody Bracket
Push-Type Retainer
Head Diameter: 15mm
Stem Length: 29mm
Fits Into 8mm Hole
GM Saturn
4 Door Models
1991 - On

UNIT PACKAGE: 25



19639

(GM: 15149708;
Chrys: 6506008AA)
Black Nylon

Radiator, Wheelhouse,
Fender & Front Bumper Cover
Push-Type Retainer
Head Diameter: 17mm
Stem Length: 16mm
Fits Into 6mm Hole
GM C & K Trucks 1999 - On
Jeep Liberty 2002 - On

UNIT PACKAGE: 25



13993

(GM:20510029;
Ford: N803362-S;
Chry: 34202672)
Black Nylon

Body Retainer
Head Dia: 11/16"
Stem Length: 7/8"
Fits Into 1/4" Hole
GM 1984-On
Ford 1984 - On

UNIT PACKAGE: 25

Inquire About
Our FasTrack Cost
Recovery Program For
Body Shops

Please Order
In Unit Package
Quantities
Not Number Of
Pieces



13996
(20452072, 20590899)
Black Nylon

Exterior Body Retainer
Head Dia: 11/16"
Stem Length: 7/8"
Fits Into 9/32" Hole
GM 1984-On

UNIT PACKAGE: 25



20869
(GM: 88970767;
Toyota: 90467-10183)
Black Nylon

Front Fender Liner
Push-Type Retainer
Head Diameter: 18mm
Stem Length: 7.5mm Hole
Fits Into 7mm Hole
Pontiac Vibe, Lexus and
Toyota
1999 - On

UNIT PACKAGE: 10



20365
(10301966, 10425306)
Black Nylon

Cowl Vent
Push-Type Retainer
Head Diameter: 18mm
Stem Length: 13mm
Fits Into 7.5mm Square Hole
Pontiac Aztek
2001 - On

UNIT PACKAGE: 10



20988
(GM: 11589289;
Chrysler: 6508863-AA)
Black Nylon

Air Distributor &
Windshield Defroster
Push-Type Retainer
Head Diameter: 18mm
Stem Length: 17.5mm
Panel Range: 2.0mm - 4.5mm
Fits Into 6.5mm Hole
Buick Enclave, Chevrolet Equinox,
Chevrolet & GMC
S & T Trucks, GMC Acadia
And Pontiac Torrent
2002 - On

UNIT PACKAGE: 25



20888
(GM: 11561368;
Chrys: 6508712AA)
Black Nylon

Fender, Wheel & Bumper
Push-Type Retainer
Head Diameter: 18mm
Stem Length: 20mm
Panel Range: 3.0mm - 5.8mm
Fits Into 9.5mm Hole
Chevrolet Impala &
Monte Carlo
And Pontiac Grand Prix
& Solstice
2004 - On
Jeep Wrangler
2000 - On

UNIT PACKAGE: 25



20880
(11589290)
Black Nylon

Air Inlet Grille,
Bumper Fascia &
Front Brake Caliper
Cooling Duct
Push-Type Retainer
Head Diameter: 18mm
Stem Length: 20mm
Panel Range: 4.5mm - 7.0mm
Fits Into 6.5mm Hole
Buick Enclave, Cadillac
CTS & STS, Chevrolet
Cobalt, Equinox & SSR,
GM Trucks and Pontiac
G5 & Torrent
2002 - On

UNIT PACKAGE: 50



20989
(GM: 11589291;
Ford: W713331-S300)
Black Nylon

Air Dam & Grille
Push-Type Retainer
Head Diameter: 18mm
Stem Length: 22mm
Panel Range:
7.0mm - 9.5mm
Fits Into 6.5mm Hole
Cadillac CTS, SRX
And STS
2003 - ON

UNIT PACKAGE: 25



16622
(10157900, 11517803,
15993201)
Black Nylon

Front Bumper
Fascia Retainer
Head Dia: 18mm
Stem Length: 23mm
Fits Into 9.5mm (3/8") Hole
Olds Cutlass 1990-On
GM Lt. Truck
1996 - On

UNIT PACKAGE: 25



20359
(11519444)
Black Nylon

Bumper Cover
Push-Type Retainer
Head Diameter: 18mm
Stem Length: 26mm
Fits Into 10mm Hole
Oldsmobile Intrigue, Pontiac
Aztek & Grand Prix
1997 - On

UNIT PACKAGE: 25



20631
(11588988)
Black Nylon

Front Bumper Cover
Push-Type Retainer
Head Diameter: 18mm
Stem Length: 26mm
Fits Into 10mm Hole
Pontiac Grand Prix
2004 - On

UNIT PACKAGE: 25



20826
(11609417)
Black Nylon

Fender Apron
Push-Type Retainer
Head Diameter: 19mm
Stem Length: 14mm
Panel Range: 2.7mm - 5.3mm
Fits Into 8.5mm Hole
Buick Enclave & LaCrosse, Cadillac
CTS, SRX & STS, Chevrolet
Cobalt, Equinox
& Malibu, GM Trucks and
Pontiac G5, G6 & Torrent
2003 - On

UNIT PACKAGE: 50



20990

(GM: 15296830;
Chrysler: 5116530-AA)
Black Nylon

Fascia & General Purpose
Push-Type Retainer
Head Diameter: 19mm
Stem Length: 16mm
Panel Range: 5.0mm - 7.0mm
Fits Into 8mm Hole
GM 2007 - On

UNIT PACKAGE: 25

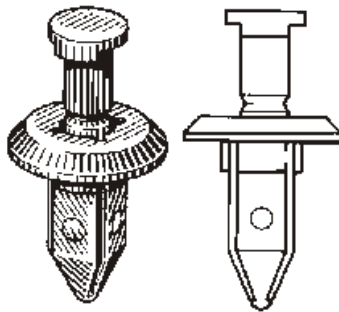

16625

(10108746)
Black Nylon

Front Bumper
Fascia Retainer
Head Dia: 20mm
Stem Length: 20mm
Fits Into 10mm Hole
GM Station Wagons 1991-On

UNIT PACKAGE: 25



20889

(GM: 11589293
Ford: W712196-S300)
Black Nylon

Cowl Vent & Fender
Push-Type Retainer
Head Diameter: 20mm
Stem Length: 22mm
Panel Range: 4.5mm - 7.0mm
Fits Into 8.5mm Hole
Buick Century, LaCrosse
& Regal, Cadillac,
Chevrolet Equinox,
GM Trucks, Hummer H3
And Pontiac Grand Prix & Torrent
1997 - On
Ford 2006 - On

UNIT PACKAGE: 25



18308

(3540858)
Black Nylon

Radiator Air Baffle
Push-Type Retainer
Large Head Diameter: 3/4"
Stem Length: 1-1/8"
Fits Into 1/4" Hole
Cadillac Eldorado
& Seville 1993-On

UNIT PACKAGE: 25



20991

(11589292)
Black Nylon

Bumper Fascia,
Flares & Air Dam
Push-Type Retainer
Head Diameter: 20mm
Stem Length: 20mm
Panel Range: 2.0mm - 4.5mm
Fits Into 8.5mm Hole
Chevrolet & GMC
C & K Trucks
2007 - On

UNIT PACKAGE: 25



20992

(11589294)
Black Nylon

Bumper Fascia, Fender
And Toe/Floor Panel
Push-Type Retainer
Head Diameter: 20mm
Stem Length: 24mm
Panel Range: 7.0mm - 10.0mm
Fits Into 8.5mm Hole
Buick Enclave & LaCrosse,
Chevrolet & GMC
C & K Trucks, GMC Acadia,
Hummer H3 and Saturn Outlook
2005 - On

UNIT PACKAGE: 25



17216

(GM: 21030249;
Ford: N807389S;
Chry: 6503598)
Black Nylon

Air Baffle To
Under Carriage
Push-Type Retainer
Head Diameter: 20mm
Stem Length: 20mm
Fits Into 8mm Hole
GM Saturn
2 Door & 4 Door
Models 1991 - On

UNIT PACKAGE: 25



19615

(15153415)
Black Nylon

Rear Bumper Cover
Push-Type Retainer
Large Head Dia.: 20mm
Stem Length: 21mm
Fits Into 9mm Hole
C & K Trucks
1999 - On

UNIT PACKAGE: 25



20632

(GM: 11518017)
Ford: W708530-S300)
Black Nylon

Bumper Cover &
Fender Shield
Push-Type Retainer
Head Diameter: 20mm
Stem Length: 26mm
Fits Into 8mm Hole
GM & Ford
1997 - On

UNIT PACKAGE: 15

Please Order
In Unit
Package Quantities
Not Number
Of Pieces

GENERAL MOTORS CLIPS & FASTENERS Sec. 20



18896
(21095797)
Black Nylon

Bumper Fascia
Push-Type Retainer
Large Head Dia.: 20mm
Stem Length: 28mm
Fits Into 8mm Hole
GM Saturn 1996 - On

UNIT PACKAGE: 25



15043
(14103461)
Black Nylon

Bumper Fascia Retainer
Head Dia.: 7/8"
Shoulder Length: 5/32"
Stem Length: 1-3/64"
Fits Into 1/2" Hole
GM 1987 - On

UNIT PACKAGE: 25

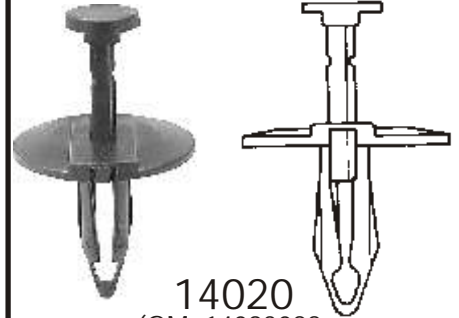

14020
(GM: 14093088;
Ford: N802781-S)
Black Nylon

Splash Shield & Fascia Retainer
Head Dia: 1
Stem Length: 7/8"
Fits Into 1/4" Hole
GM 1979 - On

UNIT PACKAGE: 25



20337
(24576759)
Black Nylon

Radiator Air Baffle
& General Purpose
Push-Type Retainer
Large Head Dia.: 20mm
Stem Length: 39mm
Fits Into 6mm Hole
Chevrolet Malibu,
Oldsmobile
Alero & Cutlass
And Pontiac Grand Am
1999 - On

UNIT PACKAGE: 15



20993
(GM: 11589295;
Ford: W712665-S300)
Black Nylon

Fender, Flare, Gas Tank
& Panel Attachment
Push-Type Retainer
Head Diameter: 25mm
Stem Length: 20mm
Panel Range: 3.0mm-6.0mm
Fits Into 10.5mm Hole
Chevrolet Cobalt & HHR,
GM C & K Trucks and
Pontiac G5
2005 - On

UNIT PACKAGE: 25



14147
(20547865)
Black Nylon

Body Retainer
Head Dia: 1"
Stem Length: 7/8"
Fits Into 1/4" Hole
GM 1984-On

UNIT PACKAGE: 25



20863
(5480772)
Black Nylon

Lower Rocker Moulding
Push-Type Retainer
Head Diameter: 22mm
Stem Length: 13mm
Fits Into 15mm Hole
Chevrolet Equinox
2005 - On

UNIT PACKAGE: 10



20994
(GM: 11589296)
Black Nylon

Panel Attachment
& General Purpose
Push-Type Retainer
Head Diameter: 25mm
Stem Length: 23mm
Panel Range: 6.0mm - 9.0mm
Fits Into 10.5mm Hole
Buick Enclave and
GMC Acadia
2007 - On

UNIT PACKAGE: 25



13994
(GM: 20570245, 20635065
Ford: N804614S)
Black Nylon

Splash Shield, Seat Cushion &
Spare Tire Retainer
Head Dia: 1"
Stem Length: 7/8"
Fits Into 5/16" Hole
GM 1984-On

UNIT PACKAGE: 25

Auveco...
The World's Largest
Supplier Of Body
Hardware & Specialty
Fasteners

Sec. 20

GENERAL MOTORS CLIPS & FASTENERS

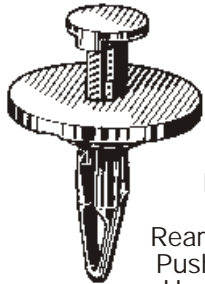

18310
(22587036)
Black Nylon

Rear Bumper Fascia
Push-Type Retainer
Head Diameter: 1"
Stem Length: 15/16"
Fits Into 3/8" Hole
Chevrolet Cavalier
& Pontiac Sunfire
1995 - On

UNIT PACKAGE: 25



15045
(10053388,
22542705)
Black Nylon

Bumper Fascia
Retainer
Head Dia: 1"
Shoulder Length: 1/8"
Stem Length: 1-7/64"
Fits Into 1/2" Hole
GM 1987-On

UNIT PACKAGE: 25



18334
(15959833)
Gray Nylon

Front License Plate
Bracket Push-Type
Retainer
Head Diameter: 1"
Stem Length: 1-3/4"
Fits Into 1/2" Hole
GM S-10 Truck
With Decor Package
1994-On

UNIT PACKAGE: 5



15702
(14101262)
Black Nylon

Plastic Cover On Eng.
Compartment Retainer
Head Dia: 1"
Shoulder Length: 1/8"
Stem Length: 15/16"
Fits Into 1/2" Hole
Buick, Olds & Pontiac
1988 - On

UNIT PACKAGE: 25

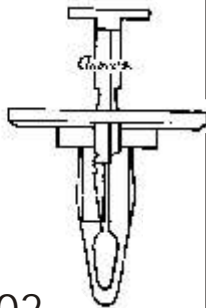

15042
(10077283)
Black Nylon

Bumper Fascia Retainer
Head Dia: 1"
Shoulder Length: 1/4"
Stem Length: 1-1/8"
Fits Into 1/2" Hole
GM 1982-On

UNIT PACKAGE: 25



17616
(21077131)
Black Nylon

Bumper Fascia
Push-Type Retainer
Head Dia: 1-3/16"
Stem Length: 2"
Fits Into 7/16" Hole
GM Saturn
1991-On

UNIT PACKAGE: 10



15044
(22535007)
Black Nylon

Bumper Fascia Retainer
Head Dia: 1"
Shoulder Length: 1/8"
Stem Length: 1"
Fits Into 1/2" Hole
GM 1987 - On

UNIT PACKAGE: 25



18268
(15959832)
Black Nylon

Front License
Plate Bracket
Push-Type Retainer
Head Diameter: 1"
Shoulder
Length: 9/64"
Stem Length: 1-5/8"
Fits Into 1/2" Hole
GM Truck 1994-On

UNIT PACKAGE: 5



20163
(25099299)
Black Nylon

Radiator Sight Shield
& Air Filter Housing
Push-Type Retainer
Head Diameter: 12.5mm
Stem Length: 17mm
Fits Into 6mm Hole
1994 - On

UNIT PACKAGE: 15



18353
(15960325)
White Nylon

Door Trim Panel
Push-Type Retainer
Head Dia: 9/16"
Stem length: 41/64"
Fits Into 1/4" Hole
GM Trucks C, K, 1, 2, 3
1995-On

UNIT PACKAGE: 50



20244
(25707329)
Green Nylon

Push-Type Retainer
With Sealer
Head Diameter: 19mm
Stem Length: 32mm
Fits Into 8mm Hole
Buick LeSabre, Oldsmobile Aurora
& Pontiac Bonneville
2000 - On
UNIT PACKAGE: 10



19417
(Chrys: 6503819,
6503401;
GM: 25631448)
Black Nylon

M7.5 x 35mm
Square Drive Truss Head
22mm Head Diameter
9mm Shoulder Diameter
Foam To Bumper Fascia
Chrysler
1993 - On
GM: 1997 - On
UNIT PACKAGE: 15



20970
Not Available From O.E.M.
Black Nylon
M14 x 34mm
Bumper and Door Insulator
Nylon Screw
22mm Head O.D.
No. 3 Square Drive
Fits Into 12mm Hole
GM, Ford & Chrysler
2005 - On
UNIT PACKAGE: 25



19387
(15989487)
Nylon

Front & Rear Door
Trim Panel Retainer
Astro & Safari Mini-Van,
S & T Trucks
1996-On
UNIT PACKAGE: 10



13860
(20478294)
Black Nylon

Carpet Retainer
Head Dia: 30mm
Fits Onto 6mm Stud
GM 1984-On
UNIT PACKAGE: 25



19530
(10281610)
Black Nylon

Air Inlet Grille Panel Retainer
Head Diameter: 30mm
Fits Onto 5mm Stud
Buick Century & Regal, Olds
Intrigue and Pontiac Grand Prix
1997 - On
UNIT PACKAGE: 15

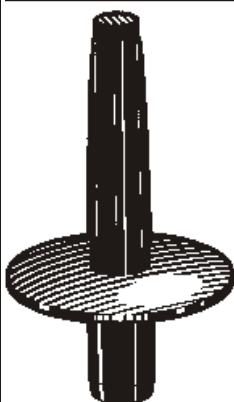

18691
(10186453)
Black Nylon

Dash Sound
Barrier Retainer
Flange Dia: 30mm
Overall Length: 52mm
Chevrolet Lumina APV,
Olds Silhouette And Pontiac Trans
Sport
1990-On
UNIT PACKAGE: 25



16953
(12337900,
14103435)
Nylon

Upper Radiator
Shield Retainer
Chevrolet Corsica
& Beretta
1987-On
UNIT PACKAGE: 10



19472
(GM: 25535963;
Ford: N811772S)
Nylon

Instrument Panel Insulation
And Front Compartment
Rear Sight Shield
Turn Retainer
Buick Electra, LeSabre, Park Ave. &
Skylark, Cadillac DeVille,
Oldsmobile Achieva, Cutlass, Delta
88, 88 Royale & 98 Regency And
Pontiac Bonneville
& Grand Am
1991 - On
Upper Deflector Shield
Ford
UNIT PACKAGE: 25

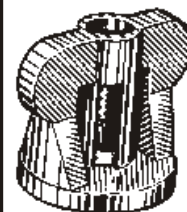

13856
(20461373)
Nylon

Rear Speaker Nut
M6 - 1.0 Thread
GM 1984-On
UNIT PACKAGE: 25

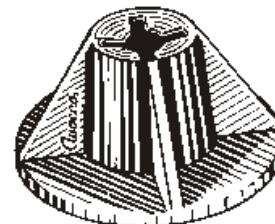

13456
(20478295)
Nylon

Carpet Retainer
GM
1985-On
UNIT PACKAGE: 10

Wire Loom Routing Clips

Black Nylon Routing Clips for Wire Loom (also called split flexible tubing, convoluted conduit or wiring harness)



19440
(12040984)
Black Nylon

Wire Loom Routing Clip
For 1/4" I.D.,
3/8" O.D. Loom

UNIT PACKAGE: 15



20397
(12160858)
Gray Nylon

Wire Loom
Routing Clip
For 10mm I.D.,
13mm O.D. Loom

UNIT PACKAGE: 15



14547
(3816659,
8917320)
Black Nylon

Wire Loom Routing Clip
For 3/4" I.D.,
1" O.D. Loom

UNIT PACKAGE: 25



19795
(12015631)
Black Nylon

Wire Loom Routing Clip
For 1/4" I.D.,
3/8" O.D. Loom

UNIT PACKAGE: 15



14545
(8911497)
Black Nylon

Wire Loom Routing Clip
For 13/32" I.D.,
19/32" O.D. Loom

UNIT PACKAGE: 25



20665
(12160374)
Black Nylon

Wire Loom Routing Clip
For 19mm I.D.,
24mm O.D. Loom

UNIT PACKAGE: 15



14544
(8911473)
Black Nylon

Wire Loom Routing Clip
For 11/32" I.D.,
1/2" O.D. Loom

UNIT PACKAGE: 25



14546
(8911472)
Black Nylon

Wire Loom Routing Clip
For 1/2" I.D.,
11/16" O.D. Loom

UNIT PACKAGE: 25



20471
(8905794)
Black Nylon

Wire Loom Routing Clip
For 10mm I.D.,
13mm O.D. Loom

UNIT PACKAGE: 15



19851
(12040983)
Black Nylon

Wire Loom Routing Clip
For 1/2" I.D.,
11/16" O.D. Loom

UNIT PACKAGE: 15



16941
(12015983)
Black Nylon

Wire Loom Routing Clip
For 1" I.D.,
1-9/32" O.D. Loom

UNIT PACKAGE: 25

GENERAL MOTORS CLIPS & FASTENERS Sec. 20



19909
(21170211)
Black Nylon

Wire Routing Clip
Stem Diameter: 9/32"
Stem Length: 7/16"
Saturn
1996 - On

UNIT PACKAGE: 25

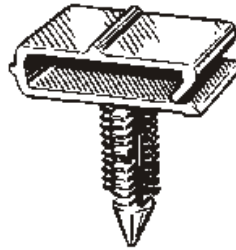

13855
(20418416)
Nylon

Shear Wall Wire Clip
Stem: 5/16" x 1" Long
GM 1984-On

UNIT PACKAGE: 25

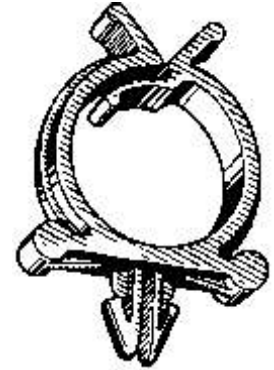

14217
(GM: 1257702,
20346654;
Ford: 383207-S;
AMC: 3693099)
Nylon

Routing Clip
GM, Ford & AMC

UNIT PACKAGE: 25



20514
(12160857)
Gray Nylon

Wiring Harness Clip
Head Size: 9mm x 37mm
Fits Into 6.3mm (1/4") Hole
GM

UNIT PACKAGE: 50

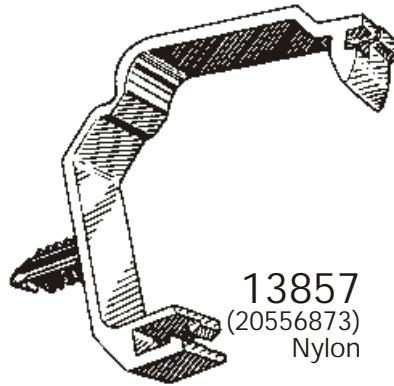

13857
(20556873)
Nylon

Inside Door Wire Clip
Stem: 1/4" x 7/32" x 9/16" Long
GM 1984-On

UNIT PACKAGE: 25

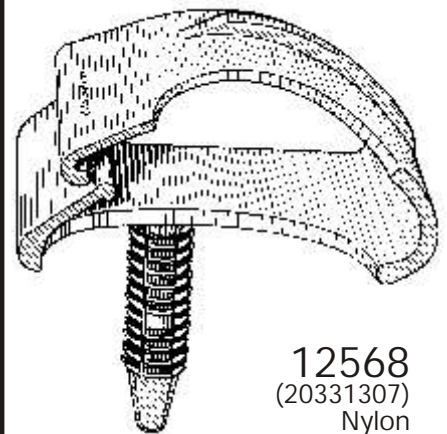

12568
(20331307)
Nylon

Wire Routing Clip
Stem: 5/16" x 11/32"
x 1-1/4" Long
GM 1981-On

UNIT PACKAGE: 10



19853
(12176844)
Gray Nylon

Wiring Harness Clip
Size: 3/8" x 2-1/2"
Stem Length: 1/2"
Fits Into 1/4" Hole
GM

UNIT PACKAGE: 25

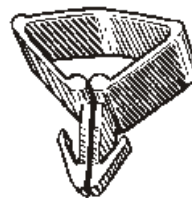

13858
(20430956)
Nylon

Wire Clip
Models With Sunroof
GM 1984-On

UNIT PACKAGE: 25



12728
(14046480)
Nylon

Wire
Retaining Clip
GM 1981-On

UNIT PACKAGE: 25



12729
(25512081)
Nylon

Engine Compartment
Wire Clip
For 1/4" Diameter Tube
Buick w/ V-6 Diesel
1985-On

UNIT PACKAGE: 25



20312
(GM: 15021761;
Chry: 5027550AB)
Yellow Nylon

Hood Prop Rod Clip
7mm Rod Diameter
Snaps Into 10mm Hole
GM Cars & Trucks 1988 - On
Chrysler PT Cruiser
Isuzu Hombre
1990 - On

UNIT PACKAGE: 10



11352
(3920179,
10013764)

Radiator Shroud Clip
Chevrolet 1968-On

UNIT PACKAGE: 100



19221
(15638098)
Nylon

Fuel Line
Retainer Clip
For 5/16" Fuel Hose
1989-On

UNIT PACKAGE: 10



11831
(554343,
562327; 1241972)

Bumper Fastener
GM 1973-On

UNIT PACKAGE: 50



18117
(10062366)

Retaining Clip
Map Pockets & Dash
GM 1990-On

UNIT PACKAGE: 25



19222
(15638097)
Nylon

Fuel Line
Retainer Clip
For 3/8" Fuel Hose
1989-On

UNIT PACKAGE: 10



The World's Largest
Selection Of Body
Hardware &
Specialty Fasteners
For The Collision
Repair Professional



20860
(15078238)
Black

Radiator Grille &
Bumper Cover Fastener
Width: 5/8"
Length: 1"
Overall Height: 5/8"
GM Trucks & Vans
1999 - On

UNIT PACKAGE: 15

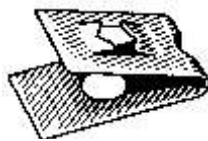

14968
(10005510)

Bumper Impact Strip
Retainer
GM 1978-On

UNIT PACKAGE: 50



19200
(25606274)
Zinc Organic

Side Marker, Parking
Light & Rear Bumper
Reflector Retainer
Buick Riviera, Cadillac
Eldorado & Oldsmobile Aurora
1995-On

UNIT PACKAGE: 25



19902
(21097292)
Natural Nylon

Hood Prop Rod Clip
5/16" Rod Diameter
Saturn
1997 - On

UNIT PACKAGE: 15

GENERAL MOTORS CLIPS & FASTENERS Sec. 20



19369
(3543865)
Zinc Organic

Bumper Filler Retainer
Cadillac Seville
1992-On

UNIT PACKAGE: 25



20883
(11588650)
Zinc

Garnish, Interior Trim, Bezel
& Scuff Plate Fastener
Width: 15/32"
Height: 11/16"
GM Cars & Light Trucks
2002 - On

UNIT PACKAGE: 10



19616
(15025531;
15764320)
Black & Gray Nylon

Radiator Grille Retainer
Long Head Dia.: 30mm
Wide Head Dia.: 19mm
Snaps Into 13mm Hole
C & K Trucks
1999-On

UNIT PACKAGE: 10



19438
(10274528,
10293836)
Black Zinc Phosphate

Bumper Fascia & Cooling
Air Inlet Duct Fastener
Cutlass, Grand Prix,
Intrigue, Lumina, Monte
Carlo & Regal
1996-On

UNIT PACKAGE: 10



20619
(15046306)
Olive Drab

Rocker Panel Fastener
Head Size: 7/16" x 1-7/16"
Overall Height: 11/16"
GM S & T Trucks
2002 - On

UNIT PACKAGE: 15



18262
(15002520,
15682898)
Zinc Organic

Radiator Grille Retainer
GM Pickup, Van, Blazer, Jimmy
1994-On

UNIT PACKAGE: 25



19519
(GM: 16662182;
Chrysler: 6502988)
Zinc Organic

Windshield Garnish Moulding,
Rear Side Door Garnish Moulding
& Liftgate Trim Finish Panel Fastener
Width: 1/2"
Height: 9/16"

Chevrolet Camaro, Corvette, &
Venture; Oldsmobile Silhouette and
Pontiac Firebird, Grand Prix &
Trans Sport
1993 - On
Chrysler 1996 - On

UNIT PACKAGE: 15



18105
(15607139)

Nameplate Retainer
GM Trucks
C & K 1987-On

UNIT PACKAGE: 15

Not Actual Size



18748
(22527147)
Black Nylon

Radiator Grille Retaining Clip
Oldsmobile Calais &
Delta 88 Royale 1986
Pontiac Bonneville 1991-88

UNIT PACKAGE: 15



20268
(15748479)
Zinc & Yellow

Garnish Moulding Fastener
Width: 1/2"
Height: 5/8"
GM Cars & Trucks
1994 - On

UNIT PACKAGE: 25

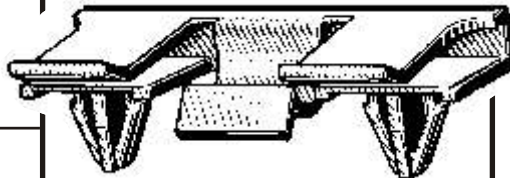

17356
(96061863)
Nylon

Radiator Grille Clip
Geo Tracker
2 Wheel & 4 Wheel Drive
1989-On

UNIT PACKAGE: 5



19502
(10056725)
Zinc Organic

Quarter Lower Trim Finish
Panel Nut
#8 Screw Size
Buick Regal, Chev. Astro, Caprice,
C & K Trucks, Lumina, Monte Carlo,
& Safari, Olds Cutlass and Pontiac
Grand Prix
1988 - On

UNIT PACKAGE: 25

Looking For A
Fastener
Not In The
Auveco Line?
E-mail Your New Item
Suggestion To:
mail@auveco.com



19317
(15707256)
Zinc Organic

Front Fender Extension
& License Plate Bracket
Retainer Nut
M6-1.0 Screw Size
GM Express &
Savanna
1996-On

UNIT PACKAGE: 10



17382
(14100784)
Phosphate

Bumper Valance Panel Retainer
Cadillac Eldorado & Seville
Chevrolet Lumina & Beretta
1987-On

UNIT PACKAGE: 25



21027
(11518531)
Zinc Organic

Fender Bracket
Retainer Nut
#8 (M4.2-1.41) Screw Size
Buick Enclave & Lucerne,
Chevrolet Equinox & Malibu,
Hummer and Pontiac G5,
G6, G8 & Solstice
2003 - On

UNIT PACKAGE: 15



20368
(11517769)
Zinc Organic

Door Trim Panel
Retainer Nut
M6-1.0 Screw Size
Buick LeSabre; Cadillac
DeVille & Seville; GM C & K
Trucks and Oldsmobile Aurora
1999 - On

UNIT PACKAGE: 10



20396
Zinc & Yellow

1/4" - 20 Specialty Insert
Grip: .030" - .165"
Head Diameter: 1/2"
Hex Size: 3/8"
Can be set with Auveco
Tool 11805

UNIT PACKAGE: 15



18153
(11561448, 15686142)
Zinc Phosphate

Radiator Grille Nut
#8 Screw Size
GM Trucks
C & K, 1, 2 & 3
1993-On

UNIT PACKAGE: 25

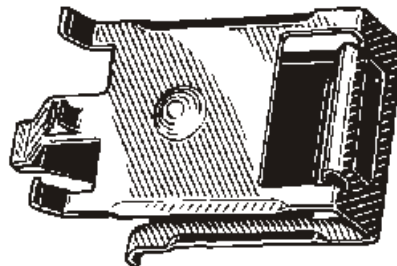

17508
(15632790)
Zinc Organic

Grille Clip
GM S-10 & S-15 Pick-Ups
1991-On

UNIT PACKAGE: 5



20742
Zinc & Yellow

M4-.7 Specialty Insert
Grip: 2mm - 3.3mm
Head Diameter: 9.5mm
Hex Size: 6.2mm
Can be set with Auveco Tool 11805

UNIT PACKAGE: 15



14820
(GM: 14083173,
17988488, 17997722,
Ford: N803685S)
Phosphate

Dash Panel Nut
Screw Size: #8 (M4.2-1.41)
GM & Ford 1982-On

UNIT PACKAGE: 25



20678
Zinc & Yellow

M5-.8 Specialty Insert
Grip: .5mm - 3.3mm
Head Diameter: 10mm
Hex Size: 7mm
Can be set with Auveco
Tool 11805

UNIT PACKAGE: 15

**Body Hardware &
Specialty Fasteners
= Auveco**



19220
(10237960)
Zinc & Yellow

M6-1.0 Specialty Insert
Grip: .7mm - 4.2mm
Head Diameter: 12.5mm
Inside Door Handle,
Window Regulator &
Air Bag Module Attachment
Chevrolet Lumina, Monte
Carlo & Pontiac Grand Prix
1995-On
Can be set With Auveco
Tool 11805

UNIT PACKAGE: 25



20415
(GM: 15685099;
Ford: N803763-S100)
Zinc & Yellow

M6-1.0 Specialty Insert w/ Sealer
Grip: .65mm - 2.0mm
Head Dia.: 12mm
Hex Size: 8mm
Roof Rack, Tailgate &
General Purpose
GM APV Vans, C & K Trucks
And Ford Explorer 1991 - On
Can be set with Auveco
Tool 11805

UNIT PACKAGE: 15



20395
(10281487)
Zinc & Yellow

M6-1.0 Specialty Insert
Grip: .7mm-4.2mm
Head Diameter: 13mm
Hex Size: 9.5mm (3/8")
Front Fender
Buick, Cadillac, Corvette,
L.D. Truck, Olds Aurora
And Pontiac
1997 - On
Can be set with Auveco
Tool 11805

UNIT PACKAGE: 15



20422
(11519952)
Zinc & Yellow

M6-1.0 Specialty Insert
Grip: .7mm-4mm
Head Diameter: 13mm
Hex Size: 9.5mm (3/8")
Front Core Support &
General Purpose
GM Envoy & Trailblazer
2002 - On
Can only be set with Pneumatic
Tool

UNIT PACKAGE: 15



20423
(11519960)
Zinc & Yellow

M8-1.25 Specialty Insert
Grip: .7mm-4mm
Head Diameter: 17mm
Hex Size: 12.5mm (1/2")
Front Core Support &
General Purpose
GM Envoy & Trailblazer
2002 - On
Can only be set with Pneumatic
Tool

UNIT PACKAGE: 15



9367
(4495047)

Front Seat
Arm Support
Hinge Pin Retainer
GM

UNIT PACKAGE: 100



15459
(1247872,
15567924)

Throttle Rod
Retaining Clip
For 1/4" Rod w/ 5/32" Groove
19/32" O.D.
GM 1975-On

UNIT PACKAGE: 50



9469
(3764554)
Nylon

Distributor To
Oil Pump Intermediate
Shaft Bushing
Chevrolet 1965-On
UNIT PACKAGE: 25



14924
PVC Plastic

Door Lock Striker Bushing
9/16" I.D., 11/16" O.D.
3/4" Long
GM 1977-On

UNIT PACKAGE: 25



20562
(9601750)

Door Lock Striker Bolt Assembly
With PVC Plastic Bushing
1/2" - 13 Thread
Overall Length: 2-1/4"
GM Cars & Trucks
1991 - 73

UNIT PACKAGE: 1



17069
(16606936,
16633853)
White Nylon

Door Lock Rod Clip
Rod Size: 4mm
Head Dia: 10mm
GM 1982-On

UNIT PACKAGE: 100



19399
(16609280)
Green Nylon

Door Handle Rod Clip
Rod Size: 5/32"
Buick Skylark, Chevrolet
Caprice & Cavalier,
Oldsmobile Achieva/Cutlass
and Pontiac Grand Am &
Sunfire
1991-On

UNIT PACKAGE: 50



18393
(20582533)
Natural Nylon

Door Lock Rod Clip
Rod Size: 5/32"
Buick Regal & Roadmaster Chevrolet
Caprice, Olds Custom Cruiser &
Cutlass And
Pontiac Grand Prix
1992-On

UNIT PACKAGE: 25

Not Actual Size



**PUT AN END TO
CONTINUAL TAILGATE
CABLE REPLACEMENT!**

20872

2004 - 1999 full size GM Pick-Up
Trucks are originally equipped with
galvanized, braided steel tailgate
cables that may corrode, weaken
and eventually break. Auveco's
new 20872 stainless steel tailgate
support straps are the ideal
replacement. Our support strap is
stronger and more durable than
cable. It mounts the same as the
original cable, uses the same
hardware and can be installed in 15
minutes. The 20872 can be used
for both sides of the tailgate.

UNIT PACKAGE: 1



Right-Hand Side Left-Hand Side

10262
Nylon

Door Lock Rod & Hood
Latch Locking Push Rod Clip
Rod Size: 5/32"
Fits Into 1/4" Hole
Chrysler, Ford, GM & AMC
UNIT PACKAGE: 20 Pieces
10 Rights - 10 Lefts



18926
(14037239,
15545178)
Natural Nylon

Tailgate Rod Clip
Rod Size: 3/16"
GM Trucks C, K 1, 2, 3
1981-On

UNIT PACKAGE: 10



19658
(16629990,
16675980)
Gray Nylon

Door Lock Rod Clip
Rod Size: 5/32"
Buick, Cadillac, Chevrolet,
Oldsmobile, Pontiac &
Trucks
1996 - On

UNIT PACKAGE: 15



19340
(3538281)
Rubber

Air Inlet Screen
Rubber Retainer
Head Diameter: 1"
Stem Length: 5/16"
Fits Into 1/4" Hole
Cadillac DeVille
1992-On

UNIT PACKAGE: 10

20675

(AMC: 4003672R;
Chry: 2945108R, 4658676;
GM: 16627328
Ford: N805350S)
White Nylon

Clip For Right-Hand Side Only

UNIT PACKAGE: 25



15518

(4234830, 12337868)

Door Lock Rod Clip
GM 1964-On

UNIT PACKAGE: 25



4406
Rubber

Brake Adjusting Screw
Hole Rubber Plug
Fits 5/16" x 1" Hole

UNIT PACKAGE: 25

14967

(AMC: 4003673L;
Chry: 2945109L, 4658677;
GM: 9815325, 16607593;
Ford: D2VZ-6521952A, N804344S)
Black Nylon

Clip For Left-Hand Side Only

UNIT PACKAGE: 50

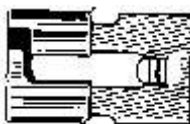

15759

(3998009,
9711304)

Door Lock Rod Clip
GM 1956-On

UNIT PACKAGE: 50



8275
Nylon

Brake Adjusting Screw
Hole Nylon Plug
Fits 3/8" x 1" Hole

UNIT PACKAGE: 100



18392
(20582532)
Black Nylon

Door Lock Rod Clip
Rod Size: 5/32"
Buick Regal & Roadmaster
Chevrolet Caprice, Olds Custom
Cruiser & Cutlass And
Pontiac Grand Prix
1992-On

UNIT PACKAGE: 25

GM Truck Door Hinge Pin & Bushing Repair Kits

Why bother with the hassle of cutting and grinding off a worn door hinge and welding on a new one when you can repair the bad hinge in a fraction of the time?

With our Door Hinge Pin & Bushing Repair Kits, fixing sagging doors caused by worn hinges due to pin failure is quick. It's easy. It works. And you don't have to repaint the welded heat flash area.

Each kit is designed to repair one hinge and contains all the pins, bushings and related hardware to do the job.

Here's how it works:

1. Remove the door from the truck body
2. Remove the original equipment pin and bushings
3. Install the bushings into the hinge holes
4. Install the longer pin into the top hinge hole
5. Thread on the lock nut
6. Install the shorter pin into the bottom hinge hole
7. Place the washer and a nut on the shorter pin
8. Tighten the nut to pull the pin into place.
9. Slowly tighten both upper and lower lock nuts
10. Reattach the door to the truck body



Detailed instructions are included with the kit.



Not Actual Size

20485
(89025539)

Door Hinge Pin and Bushing Kit
Cadillac Escalade
2006 - 2000
Chevrolet Silverado
& GMC Sierra:
1500/2500, HD / 3500, HD
2007 - 1999
Chevrolet Suburban 1500/2500
& Tahoe
2006 - 2000
GMC Yukon 2006 - 2001

UNIT PACKAGE: 1 Kit



Not Actual Size

21092
(89025543)

Extended Cab Rear
Door Hinge Pin and
Bushing Kit
Chevrolet Silverado &
GMC Sierra:
1500/2500/3500
2005 - 1999,
1500HD/2500HD/3500HD
2005 - 01
1500/2500HD
Classic Hybrid LT 2007 - 06,
1500 Classic Hybrid 2007 - 05

UNIT PACKAGE: 1 Kit

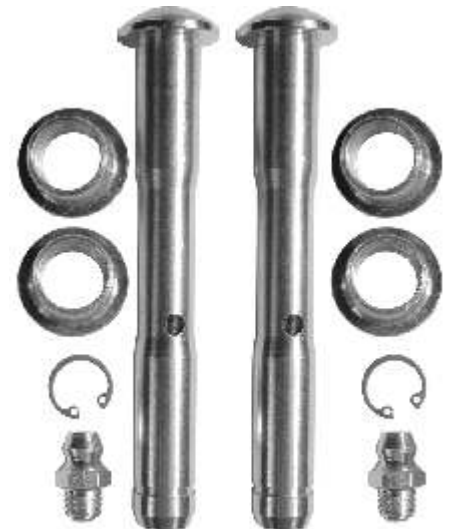

Not Actual Size

21072
(89025546)

Side Cargo Door
Greaseable Stainless Steel
Hinge Pin & Bushing Kit
Use With Auveco Hinge #20833
GM Savana Van &
Express Van
2008 - 1996

UNIT PACKAGE: 1 Kit



20833

Not Available From OEM

Side Cargo Door Hinge
Use With Auveco Pin &
Bushing Kit 21072
GM Savana Van &
Express Van
2006 - 1996

UNIT PACKAGE: 1



Not Actual Size

19725

Not Available
From O.E.M.
Zinc

Door Roller Pin
Assembly
Diameter: 9/16"
Length: 5-1/2"
Roller O.D.: 3/4"
Roller Groove Dia: 5/8"
Knurl Dia: 19/32"
GM C & K
Light Duty Trucks
2000 - 88

UNIT PACKAGE: 1



Not Actual Size

19782

(15672183)
Zinc

Door Roller
Pin Assembly
Pin Diameter: 25/64"
Overall Length: 5-1/16"
Roller O.D.: 3/4"
Roller Groove
Diameter: 5/8"
Use With Auveco 8829
E-Type Retaining Ring
Rear Door Upper Hinge
S & T Trucks
1994 - On

UNIT PACKAGE: 1



Not Actual Size

19781

(15653790)
Zinc & Yellow

Door Hinge Pin
Length: 4-1/8"
Pin Diameter: 11/32"
Shoulder O.D.: 3/8"
Head O.D.: 1/2"
Use With Auveco
Bushings
16936 & 16937 &
Pin Retainer 17976
S & T Trucks
1994 - On

UNIT PACKAGE: 2



Not Actual Size

14559

(GM: 6271989,
20046147)
Phosphate

Door Hinge Pin
Length: 4-1/16"
Pin Dia: 11/32"
Head O.D.: 9/16"

- Buick: Estate Wagon & LeSabre Wagon 90-82, Electra 82, Regal 87-82, Riviera 85-82, All exc. Skyhawk 77-76;
- Cadillac: Cimarron 88-82, Eldorado & Seville 85-82, Fleetwood
- Chevrolet: Brougham 92-82; Camaro 81-78, C & K Trucks 84 - 73 Monte Carlo, Malibu & El Camino 88-76 Impala & Caprice 90-82, Nova 79-77;
- Oldsmobile: Cutlass Supreme, Calais & Cruiser 88-76, Delta 88 90-77, Omega 79-77, Toronado 85-82, 98 Recency 82-77;
- Pontiac: Firebird 81-78, Grand Prix 87-77, LeMans & Grand Am 81-77 Phoenix & Ventura 79-77, Safari & Parisienne 89-83

UNIT PACKAGE: 10



Not Actual Size

19183

(GM: 20043351)
Phosphate

Door Hinge Pin
Length: 4"
Pin Dia: 11/32"
Head O.D.: 7/16"

- Buick: Skyhawk 88-82, Skylark 85-82;
- Chevrolet: Cavalier 94-82, Celebrity 90-82, Chevette 87-78, Citation 85-80
- Oldsmobile: Cutlass Ciera 95-82, Firenza 88-82, Omega 84-80,
- Pontiac: Phoenix 84-80, Sunbird 94-82, T-1000 87-82 6000 91-82

UNIT PACKAGE: 10

GENERAL MOTORS CLIPS & FASTENERS Sec. 20



Not Actual Size

19424

(15591860; 15691595;
15967691; 88891731)
Stainless Steel

Door Hinge Pin
Length: 5-1/4"
Pin Dia: 11/32"
Shoulder O.D.: 3/8"
Head O.D.: 9/16"

GM Trucks
C-K Models 1988-On
Use With Auveco
Bushings 16936 & 16937
& Pin Retainer 17976

UNIT PACKAGE: 4



17976

(15562610)
400 Series
Stainless Steel

Door Hinge Pin Retainer
21/64" I.D., 9/16" O.D.

1/64" Thick
GM Trucks C-K
1988-On

Used With 19424 & 19781
Door Hinge Pin

UNIT PACKAGE: 50



Not Actual Size

17436

(10102434)
Phos. & Oil

Trunk Lid Hinge Pin
Length: 2-21/32"
Pin Dia: 11/32"
Head O.D.: 15/32"
Buick Regal, Cadillac,
Eldorado & Seville,
Chevrolet Lumina,
Oldsmobile Cutlass
& Pontiac Grand Prix
1988-On

UNIT PACKAGE: 10



Not Actual Size

17343

(15646148)
Stainless Steel

Door Hinge Pin
Length: 4-1/8"
Pin Dia: 11/32"
Shoulder O.D.: 3/8"
Head O.D.: 9/16"

GM Trucks
C-K 1,2,3
4 Door Pick-Up
Rear Door
1992-On

UNIT PACKAGE: 5



17437

(12338015,
14066728)
Zinc & Yellow

Door Hinge Pin
Length: 4-5/32"
Pin Dia: 11/32"
Head O.D.: 15/32"
GM Astro Van,
Safari Van & S-10
1982-On

UNIT PACKAGE: 5



Not Actual Size

17345

(12337927, 15537954,
15660361)
Zinc

Door Hinge Pin
Length: 4-13/16"
Pin Dia: 15/64"
Head O.D.: 7/16"
GM Suburban &
4 Door Jimmy/Blazer
End Gate
1992-On

UNIT PACKAGE: 5



Not Actual Size

17344

(15598845)
Stainless Steel

Door Hinge Pin
Length: 3-1/4"
Pin Dia: 11/32"
Head O.D.: 1/2"
GM Astro &
Safari Mini-Vans
Rear Door
1985-On

UNIT PACKAGE: 5



Not Actual Size

17435

(20558726)
Zinc & Black

Lift Gate Hinge Pin
Length: 3-5/8"
Pin Dia: 3/16"
Head O.D.: 13/32"
Buick Century,
Chevrolet Celebrity,
Oldsmobile Ciera
& Pontiac 6000
Station Wagons
1984-On

UNIT PACKAGE: 5

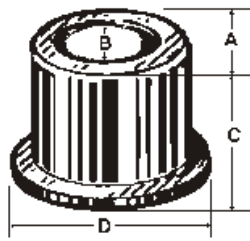

Door Hinge Bushings

Auveco Part No.	Dimensions			
	O.D. "A"	I.D. "B"	Height "C"	Flange O.D. "D"
14548	1/2"	3/8"	15/32"	5/8"
14549	1/2"	11/32"	3/8"	19/32"
14550	27/64"	11/32"	19/64"	19/32"
14553*	31/64"	11/32"	23/64"	19/32"
16936*	1/2"	11/32"	23/64"	43/64"
16937*	17/32"	25/64"	23/64"	11/16"

*Splined O.D.



14548
(9822198)

Buick 1975-42
Chevrolet:
Monza & Vega
1980-76
All (Exc. Corvette)
1975-62
Olds Starfire 1980-76
Pontiac:
Astre &
Sunbird 1980-76
All 1975-49

UNIT PACKAGE: 25



14549
(9716926, 20345137)
Thick Bushing

Buick 1976-On
Cadillac 1980-On
Chevrolet:
All 1976-On
Corvette 1982-73
Olds
Exc. Starfire 1980-On
Pontiac Exc. Astre &
Sunbird 1980-On

UNIT PACKAGE: 25



14550
(GM: 9721917;
Ford: D1AZ-6522841A)

Buick (Exc. Skyhawk)
1967-On
Cadillac 1946-On
Chevrolet:
Exc. Monza & Vega
1962-On
Corvette 1956-On
GM
C & K Trucks 1993 - 79
Olds Exc.
Starfire 1949-On
Pontiac Exc. Astre &
Sunbird 1932-On

UNIT PACKAGE: 25



14553
(20429500)

Splined O.D.
All GM (Including Pick-Ups
& Vans) 1968-On

UNIT PACKAGE: 25



16936
(12338074, 15691493, 15964971, 16632193)

Splined O.D.
Side Door Upper Hinge
GM Trucks
C-K Models 1988-On

UNIT PACKAGE: 25



16937
(15562609, 15964972 & 16632192)

Splined O.D.
Side Door Lower Hinge
GM Trucks
C-K Models 1988-On

UNIT PACKAGE: 25



12314
(20037597)

Clear Knob
GM 1952-On

UNIT PACKAGE: 1



12315
(1732326)

Black Knob
GM 1952-On

UNIT PACKAGE: 1



12316
(458030)

GM Trucks 1977-On

UNIT PACKAGE: 1

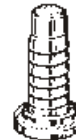
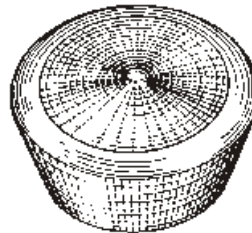

18195
Clear

Window Crank
Handle Knob
GM 1952-On

UNIT PACKAGE: 2

HELPFUL HINTS.....

FOR USING THE AUVECO CATALOG

1. The color-coded pages signify various sections:
 BLUE-Metric Items
 BEIGE-Electrical Accessories
 GREEN-Assortments, Cabinets, Bins & Racks
 GRAY-Key Blanks & Accessories
 PINK-Import Car Body Hardware
2. Most illustrations are actual size. You should be able to set a part on top of the illustration to positively identify it.
3. Our Display Boards, which are shown on the four-color pages in the front of the catalog, are a great aid in identifying product.
4. We have three different indexes in the front of the catalog to assist you.
 PICTORIAL QUICK INDEX
 ALPHABETICAL INDEX
 NUMERICAL INDEX
5. There are two OEM Part Number To AUVECO Part Number Cross References at the back of the catalog.