



**17440**  
(91501-SG0-003)  
Nylon

Body Side Moulding Clip  
Legend 1987-On

UNIT PACKAGE: 15



**19226**  
(90157-SP0-901)  
Nylon

Front Grille Clip  
Acura Legend Coupe  
1991-On  
Honda Odyssey  
1995-On

UNIT PACKAGE: 15



**19225**  
(91501-SP1-003)  
Nylon

Side Sill  
Garnish Moulding Clip  
Legend Coupe  
1991-On

UNIT PACKAGE: 10



**19507**  
(91504-SP1-003)  
White Nylon

Fender Moulding Clip  
Legend Coupe  
1995 - 91

UNIT PACKAGE: 5



**19740**  
(90666-SSO-003)  
White Nylon

Roof Moulding Clip  
Acura Integra & Legend  
Honda Prelude  
1992-On

UNIT PACKAGE: 10



**17323**  
(91513-SP0-003)  
Teal Nylon

Windshield Side Moulding Clip  
Use With 17324  
4 Door Legend 1991-On

UNIT PACKAGE: 10



**17324**  
(91511-SP0-003)  
Teal Nylon

Windshield Side Moulding Clip  
Use With 17323 & 18404  
4 Door Legend 1991-On

UNIT PACKAGE: 10

Visit The Auveco  
Web Site At  
[www.auveco.com](http://www.auveco.com) For  
The Latest Information  
On New Items.

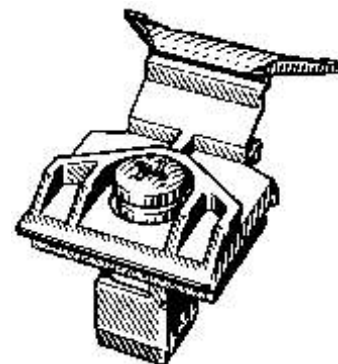

**18235**  
(91575-SL4-0040)  
Black Nylon  
w/Stainless  
Steel Screw

Windshield  
Holder Clip  
Vigor 1992-On

UNIT PACKAGE: 5



**17280**  
(91505-SG0-003)  
Orange Nylon

Windshield Moulding Clip  
Honda Prelude 1988-On  
Acura Legend 1988-On

UNIT PACKAGE: 10



**17282**  
(91534-SM4-003)  
White Nylon

Windshield Moulding Clip  
Honda Accord 1990-On  
Acura Legend 1991-On

UNIT PACKAGE: 10



**18756**  
(90621-SK7-003)  
White Nylon

Windshield Corner Moulding Clip  
Integra 1993-90

UNIT PACKAGE: 5

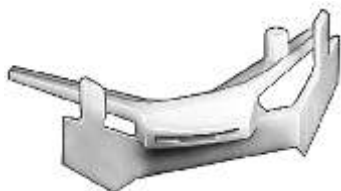

**18763**  
(90611-SK7-003)  
White Nylon

Windshield Corner Moulding Clip  
Integra 1993-90

UNIT PACKAGE: 5



**18764**  
(91514-SP0-003)  
Yellow Nylon

Windshield Side Moulding Clip  
Legend 4 Door  
1991-On

UNIT PACKAGE: 5



**18761**  
(91536-SP0-003)  
Light Blue Nylon

Windshield Corner Moulding Clip  
Legend 4 Door 1991-On

UNIT PACKAGE: 5



**19668**  
(91533-ST0-003)  
Yellow Nylon

Windshield Moulding Clip  
Integra  
1994-On

UNIT PACKAGE: 10



**18757**  
(91527-SP1-003)  
Green Nylon

Windshield Side Moulding Clip  
Legend 2 Door 1991-On

UNIT PACKAGE: 5



**18755**  
(91513-SP1-003)  
Gray Nylon

Windshield Side Moulding Clip  
Legend Coupe  
1991-On

UNIT PACKAGE: 10



**18759**  
(90601-SK7-003)  
Green Nylon

Windshield Side Moulding Clip  
Integra 3 & 4 Door  
1993-90

UNIT PACKAGE: 15

The Auveco FC-1  
Flip Chart Is A Great  
Selling Tool.  
Use It To Help  
Boost Your Sales.  
Refer To The Color  
Pages At The Front  
Of The Book.

# ACURA CLIPS & FASTENERS



**18765**  
(90612-SK7-003)  
White Nylon

Windshield Side Moulding Clip  
Integra 1993-90

UNIT PACKAGE: 10



**19478**  
(91574-SV2-003)  
Yellow Nylon

Windshield Moulding Clip  
Acura 2.2CL, 2.3CL & 3.0CL;  
Honda Accord  
1994 - On

UNIT PACKAGE: 15



**18760**  
(91514-SP1-003)  
Red Nylon

Windshield Side Moulding Clip  
Legend 2 Door  
1991-On

UNIT PACKAGE: 5



**18754**  
(91535-SP0-003)  
Green Nylon

Windshield Corner Moulding Clip  
Legend 4 Door  
1991-On

UNIT PACKAGE: 5



**18768**  
(91526-SP0-003)  
White Nylon

Windshield Side Moulding Clip  
Legend 4 Door  
1991-On

UNIT PACKAGE: 5



**18767**  
(91526-SP1-003)  
Blue Nylon

Windshield Side Moulding Clip  
Legend 2 Door 1991-On

UNIT PACKAGE: 5



**19476**  
(91577-SV4-003)  
Red Nylon

Windshield Left-Hand Corner  
Moulding Clip  
Acura 2.2CL, 2.3CL & 3.0CL;  
Honda Accord & Odyssey  
1994 - On

UNIT PACKAGE: 10

**18758**  
(91528-SP1-003)  
Yellow Nylon

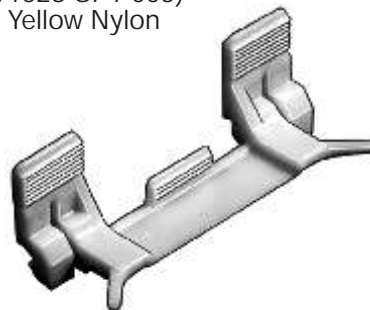

Windshield Side Moulding Clip  
Legend 2 Door  
1991-On

UNIT PACKAGE: 5



**19477**  
(91576-SV4-003)  
Green Nylon

Windshield Right-Hand Corner  
Moulding Clip  
Acura 2.2CL, 2.3CL & 3.0CL;  
Honda Accord & Odyssey  
1994 - On

UNIT PACKAGE: 10

Please Order In Unit  
Package Quantities  
Not Number Of  
Pieces



**18762**  
(91512-SP1-000)  
Black Nylon

Windshield Upper Moulding Clip  
Legend 2 Door  
1991-On

UNIT PACKAGE: 5

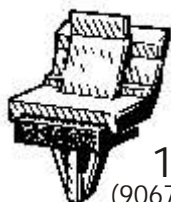

**17268**  
(90676-SD2-003)  
White Nylon

Quarter Window  
Moulding Clip  
Integra 1985-On

UNIT PACKAGE: 15



**19465**  
(91652-SPO-003)  
Natural Nylon

Center Pillar Garnish  
Screw Grommet  
#4 Screw Size 3.5 RL  
1996 - On

UNIT PACKAGE: 15

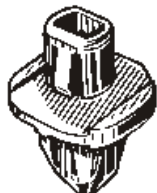

**18456**  
(90661-ST7-003)  
Nylon

Bumper Clip  
Integra 1994-On

UNIT PACKAGE: 5

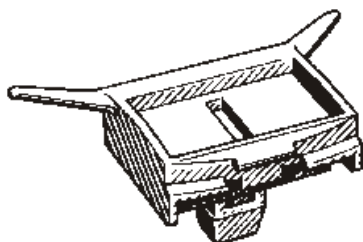

**18236**  
(91537-SP0-013)  
White Nylon

Windshield Clip  
Legend 1991-On

UNIT PACKAGE: 10



**19463**  
(91651-SZ3-003)  
Natural Nylon

Inner Front Door Lining  
Sash Garnish Grommet 3.5RL  
1996 - On

UNIT PACKAGE: 10



**17608**  
(91568-SL4-003)  
Black Nylon

Windshield Side Moulding Clip  
Vigor 1992-On

UNIT PACKAGE: 15



**19734**  
(90107-SX0-003)  
Black Nylon

Bumper Grommet  
#10 Screw Size  
Acura 2.2CL, 2.3CL,  
2.5TL, 3.2TL, 3.5RL  
Honda Accord & Prelude  
1996-On

UNIT PACKAGE: 15



**19723**  
(91503-SK7-013)  
Saddle Tan Nylon

Center Pillar Moulding  
Screw Grommet  
#4 Screw Size  
Head Size: 10mm x 14mm  
Stem Length: 10mm  
Integra  
1994 - On

UNIT PACKAGE: 15



**19479**  
(91561-SW5-003)  
White Nylon

Windshield Moulding Clip  
TL 2.5 & 3.2  
1996 - On

UNIT PACKAGE: 15



**19679**  
(91641-SH3-013)  
Yellow Nylon  
w/ Steel Insert

Garnish Moulding Grommet  
Head Diameter: 14mm x 26mm  
Acura Integra, Honda Civic  
& Prelude  
1988 - On

UNIT PACKAGE: 10



**20954**  
(90682-SEA-003)  
Black Nylon

Fender Apron Grommet  
Head Diameter: 20mm  
Stem Length: 12mm  
Fits Into 9mm Square Hole  
Acura TSX and  
Honda Civic & Odyssey  
2004 - On

UNIT PACKAGE: 25



**20472**

(91512-SR3-004)  
White Nylon

Tubular Nut  
With Sealer & Sealed End  
3mm Stud Size  
Head Dia: 8.5mm  
Fits Into 6mm Hole  
Emblem Nut  
Acura Integra,  
Honda Accord, Civic,  
CR-V & Prelude  
1994 - On

UNIT PACKAGE: 10



**19467**

(91501-SL4-003)  
Black Nylon

Front Cowl Retaining Clip  
Head Diameter: 13mm  
Stem Diameter: 6mm  
Stem Length: 10mm  
3.5RL  
1996 - On

UNIT PACKAGE: 25



**18746**

(90700-SJ4-000)  
Black Nylon

Hood Insulation Retainer  
Head Diameter: 30mm  
Stem Diameter: 15mm x 18mm  
Stem Length: 6mm  
Legend 1991-On  
Honda 1998-On

UNIT PACKAGE: 15



**18877**

(91530-SP1-003)  
Orange Nylon

Weatherstrip Retainer  
Head Size: 5mm x 15mm  
Stem Length: 10mm  
Fits Into 6mm Hole  
Acura 3.5 RL;  
Accord, Civic & Odyssey  
1992-On

UNIT PACKAGE: 25



**19114**

(91518-SM4-003)  
Black Nylon

Hood & Trunk Moulding  
Retaining Clip  
Head Diameter: 12mm  
Stem Length: 9mm  
Fits Into 6mm Hole  
Acura Integra & Honda Civic  
1994-On

UNIT PACKAGE: 10



**20609**

(91501-S1K-003)  
Black Nylon

Hood Insulation Retainer  
Head Diameter: 30mm  
Stem Diameter: 15mm x 20mm  
Stem Length: 14mm  
Acura 3.5RL & RSX and  
Honda Civic & CR-V  
2000 - On

UNIT PACKAGE: 25



**18114**

(91520-SM4-C010)  
Black Nylon

Hood Insulation Retaining Clip  
Head Diameter: 10mm  
Stem Length: 10mm  
Panel Thickness: 4mm  
Fits Into 6mm Hole  
Honda & Acura 1990-On

UNIT PACKAGE: 25



**19483**

(91515-SR3-000)  
Black Nylon

Rear Hood Cowl  
Weatherstrip Retaining Clip  
Head Size: 8mm x 18mm  
Stem Length: 15mm  
Fits Into 7mm Hole  
Acura Integra, Honda Civic, CR-V  
And Del Sol  
1992 - On

UNIT PACKAGE: 25



**19464**

(90667-SD4-003)  
Natural Nylon

Roof Lining Retainer  
Small Head Diameter: 13mm  
Large Head Diameter: 16mm  
Stem Diameter: 7mm  
Stem Length: 13mm  
NSX, 2.2CL & 2.3CL  
1991 - On

UNIT PACKAGE: 15



**19506**

(90666-SA7-003ZW)  
Black Nylon

Trunk Lining Retainer  
Head Diameter: 16mm  
Stem Diameter: 5mm Square  
Stem Length: 16mm  
Acura 2.5TL, 3.2TL, 3.5,  
Integra & Legend,  
Honda Accord Wagon & Prelude  
1987 - On

UNIT PACKAGE: 15



**19746**

(91652-SZ3-003)  
White Nylon

Door Lining Retainer  
Head Diameter: 10.5mm  
Stem Length: 15mm  
3.5RL  
1996-On

UNIT PACKAGE: 10



**21107**

(90602-SX0-003)  
White Nylon

Cowl Vent Retainer  
Top Head Diameter: 12mm  
Bottom Head Diameter: 16mm  
Stem Diameter: 4mm  
Stem Length: 13mm  
Acura MDX and Honda Civic,  
Insight, Odyssey & Prelude  
1995 - On

UNIT PACKAGE: 10



**19466**  
(91560-SZ3-003)  
White Nylon

Door Trim Panel Retainer  
Small Head Diameter: 13mm  
Large Head Diameter: 17mm  
Stem Diameter: 9.5mm  
Stem Length: 12mm  
3.5RL 1996 - On

UNIT PACKAGE: 15



**21059**  
(90602-S5A-003)  
Blue Nylon

Cowl Vent Retainer  
Top Head 12mm x 13mm  
Middle Head Diameter: 16mm  
Bottom Head Diameter: 18mm  
Stem Diameter: 8.5mm x 8.5mm  
Stem Length: 14mm  
Acura RSX and  
Honda Civic & CR-V  
2001 - On

UNIT PACKAGE: 15



**19233**  
(Acura: 91503-SZ3-003)  
Black Nylon

Front Bumper Push-Type Retainer  
Head Diameter: 20mm  
Stem Length: 13mm  
Fits Into 10mm Hole  
Acura 3.5 RL Sedan & Honda  
1996-On

UNIT PACKAGE: 15



**19145**  
(91560-SP0-003)  
Gray Nylon

Front & Rear Door  
Trim Panel Retainer  
Small Head Dia: 13mm  
Large Head Dia: 17mm  
Stem Diameter: 9mm  
Stem Length: 12mm  
Acura Integra & Legend  
Honda Accord, Civic,  
Prelude, Odyssey & Del Sol  
1991-On

UNIT PACKAGE: 25



**19186**  
(90657-SB0-003)  
Black Nylon

Front Bumper Cover  
Push-Type Retainer  
Head Diameter: 11mm  
Stem Length: 10mm  
Fits Into 8mm Hole  
Acura Legend, Honda Accord &  
Odyssey  
1991-On

UNIT PACKAGE: 10



**19239**  
(91512-SX0-003)  
Black Nylon

Front Fender  
Push-Type Retainer  
Head Diameter: 20mm  
Stem Length: 11mm  
Fits Into 8mm Hole  
Acura 3.5RL, Honda Accord,  
Prelude & Odyssey 1994-On

UNIT PACKAGE: 25



**20411**  
(91560-S84-A11)  
Black Nylon

Windshield Garnish  
Pillar Retainer  
Top Head Dia: 13mm  
Middle Head Dia: 16mm  
Bottom Head Dia: 14.5mm  
Stem Diameter: 9.5mm  
Stem Length: 12mm  
Acura 3.2CL, Honda Accord,  
Insight & Odyssey  
1998 - On

UNIT PACKAGE: 15



**19232**  
(91502-SZ5-003)  
Black Nylon

Front Fender  
Push-Type Retainer  
Head Diameter: 17mm  
Stem Length: 13mm  
Fits Into 7mm Hole  
3.5 RL Sedan  
1996-On

UNIT PACKAGE: 10



**20564**  
(91503-SZ5-003)  
Black Nylon

Front & Rear Bumper  
Push-Type Retainer  
Head Diameter: 20mm  
Stem Length: 18mm  
Fits Into 10mm Hole  
Acura 3.5RL and Honda Accord  
& Odyssey  
1996 - On

UNIT PACKAGE: 15



**20959**  
(91560-S9A-A01)  
Blue Nylon

Door Panel Retainer  
Top Head Diameter: 13mm  
Middle Head Diameter: 16mm  
Bottom Head Diameter: 15mm  
Stem Diameter: 9.5mm  
Stem Length: 13mm  
Acura TL & TSX and  
Honda Accord, Civic, CR-V  
& Odyssey  
2002 - On

UNIT PACKAGE: 25



**19231**  
(91505-SL0-003)  
Black Nylon

Push-Type Retainer  
Head Diameter: 18mm  
Stem Length: 16mm  
Fits Into 8mm Hole  
NSX  
1991-On

UNIT PACKAGE: 15



**19140**  
(Acura: 90505-SL0-003;  
GM: 94852368;  
Mitsubishi: MB888869;  
Toyota: 90467-08155)  
Black Nylon

Push-Type Retainer  
Head Diameter: 20mm  
Stem Length: 21mm  
Fits Into 8mm Hole  
Acura, Dodge Avenger,  
Eagle Talon, Geo  
Prizm, Mitsubishi  
Eclipse & Galant And  
Toyota 1993-On

UNIT PACKAGE: 5



**17267**  
(91503-SP0-003)  
Black Nylon

Front & Rear Bumper  
Push-Type Retainer  
Head Diameter: 20mm  
Stem Length: 15mm  
Fits Into 10mm Hole  
Legend 1991-On

UNIT PACKAGE: 15



**20380**

Not Supplied By O.E.M.  
Black Nylon

Cable Strap  
Length: 200mm (8")  
Max. Bundle Dia: 44mm (1-3/4")  
Fits Into 6.3mm (1/4") Hole  
Import Cars

UNIT PACKAGE: 25

## BMW CLIP & FASTENERS



**12641**  
(1-802-389-B)  
Nylon

Body Side Moulding  
Clip With Sealer

UNIT PACKAGE: 25

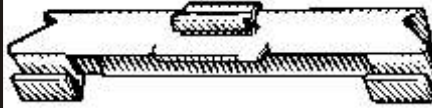

**17279**  
(5131-1-938-494)  
Nylon

Windshield Moulding Clip  
BMW 7 Series 1987-On

UNIT PACKAGE: 15



**20403**  
(51471-840-960)  
White Nylon

Scuff Plate Retainer  
Head Size: 9mm x 12mm  
Stem Length: 12mm  
Fits Into 6mm Hole  
Series 3, 5, Z3 & M  
1992 - On

UNIT PACKAGE: 25



**13158**  
(5113-1-804-205)  
Nylon

Moulding Clip  
With Sealer

UNIT PACKAGE: 50



**20333**  
(51-71-8-108-613)  
White Nylon

Cowl & Trunk Trim Clip  
Head Size: 11mm x 14mm  
Stem Length: 11mm  
Fits Into 9mm Hole  
Series 3, 5, 7, & 8  
1989 - On

UNIT PACKAGE: 25



**20255**  
(51-47-1-928-808)  
White Nylon

Scuff Plate Retainer  
Head Size: 11mm x 15mm  
Overall Length: 29mm  
Series 3, 5 & 7  
1987 - On

UNIT PACKAGE: 25

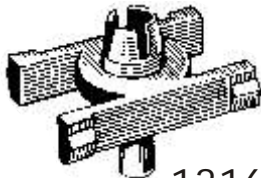

**13163**  
(5113-1-849-724)  
Nylon

Moulding Clip

UNIT PACKAGE: 10

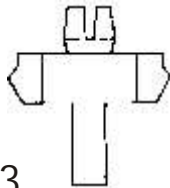

**13172**  
(5147-1-840-961)  
Nylon

Plastic Plug

UNIT PACKAGE: 25

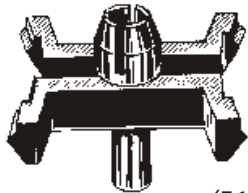

**13171**  
(5113-1-848-312)  
Nylon

Moulding Clip

UNIT PACKAGE: 10



**17645**  
(51711-916-197)  
Nylon

Headlight Cover Retainer  
BMW 3, 5, & 7 Series  
1984-On

Used With 17646

UNIT PACKAGE: 25



**17646**  
(51711-916-199)  
Nylon

Headlight Cover Grommet  
3, 5 & 7 Series 1984-On  
Used With 17645

UNIT PACKAGE: 25

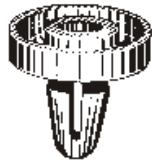

**13166**  
(5118-1-852-299)  
Nylon

Nut Type Fastener

UNIT PACKAGE: 50



**20270**  
(51-48-1-938-725)  
Black Nylon

Hood & Trunk Insulation  
Push-Type Retainer  
Head Dia: 20mm  
Stem Length: 9mm  
Fits Into 7mm Hole  
BMW Series 3, 5 & 7  
2001 - 84

UNIT PACKAGE: 25



**13159**  
(5113-5-680-113)  
Nylon Nut

UNIT PACKAGE: 50



**13164**  
(4133-5-480-120)  
Nylon

Plastic Nut  
4mm Thread

UNIT PACKAGE: 25



**13170**  
(5131-1-802-258)  
Nylon

Barrel Nut  
For 7mm Stud  
Fits Into 8mm Hole

UNIT PACKAGE: 50



**20253**  
(51-41-1-973-500)  
White Nylon

Trim Panel Retainer  
Top Head Dia: 14mm  
Middle Head Dia: 15mm  
Bottom Head Dia: 18mm  
Stem Dia: 9mm  
Stem Length: 15mm  
Series 3, 5 & 7  
1987 - On

UNIT PACKAGE: 50



**20734**  
(51-11-1-944-537)  
Black Nylon

Bumper, Wheel Opening,  
Scuff Plate & Interior Trim  
Push-Type Retainer  
Head Diameter: 20mm  
Stem Length: 15mm  
Fits Into 6.3mm Hole  
Series 3, 5, 7 & X5  
1989 - On

UNIT PACKAGE: 50



**20186**  
(51-14-1-902-279)  
Natural Nylon

Emblem Grommet  
Head Diameter: 12mm  
Stem Length: 8mm  
Fits Into 6.8mm Hole  
BMW Series 3, 5, 6 & 7  
2001 - 1986

UNIT PACKAGE: 15



**20234**  
(51-11-1-908-077)  
Black Nylon

Scuff Plate  
Push-Type Retainer  
Head Diameter: 15mm  
Stem Length: 15mm  
Fits Into 6.3mm Hole  
Series 3, 5, & 7  
1984 - On

UNIT PACKAGE: 50



**20248**  
(51-11-8-174-185)  
Black Nylon

Bumper Trim  
Push-Type Retainer  
Head Diameter: 20mm  
Stem Length: 17mm  
Fits Into 6.3mm Hole  
Series 3, 5 & 7  
1995 - On

UNIT PACKAGE: 25



**20254**  
(51-13-8-124-389)  
Black Plastic

Cowl Panel  
Moulding Insert  
Head Dia: 13mm  
Stem Length: 11mm  
Stem Diameter: 9mm  
Use With Auveco 20388  
Series 3 & 5  
1989 - On

UNIT PACKAGE: 50



**20388**  
(51218-205-295)  
Black Nylon

Cowl Vent  
Push-Type Retainer  
Head Diameter: 20mm  
Stem Length: 16mm  
Use With Auveco 20254  
Series 5  
1997 - On

UNIT PACKAGE: 50



**16115**  
(5113-1-885-399)  
Black Nylon

Push-Type Retainer  
Head Size: 7mm x 15mm  
Stem Length: 17mm  
Fits Into 6mm x 6mm Hole

UNIT PACKAGE: 25



**13167**  
(5121-6-442-159)  
Nylon

Moulding Insert  
UNIT PACKAGE: 25



**BMW (Cont.)**



**20653**  
Gray Nylon

Wire Routing Clip  
Inside Diameter: 7mm x 10mm  
Fits Into 6mm Hole  
BMW & Mercedes  
UNIT PACKAGE: 50



**13221**  
(0712-9-925-706)  
Plated

"U" Type Nut  
2.9mm Screw Size  
Panel Range: .5mm-1.5mm  
Center of Hole To Edge: 6mm  
UNIT PACKAGE: 50



**13223**  
(BMW:0712-9-925-708;  
Mercedes: 000-994-25-45)  
Plated

"U" Type Nut  
4.2mm (#8) Screw Size  
Panel Range: 3mm -4mm  
Center of Hole to Edge: 7mm  
UNIT PACKAGE: 50



**13216**  
Zinc

"U" Type Nut  
4.8mm (#10) Screw Size  
Panel Range: .9mm -2mm  
Center of Hole to Edge: 8mm  
UNIT PACKAGE: 25



**13218**  
(BMW: 0712-9-925-737;  
Mercedes: 000-994-06-45)  
Plated

"U" Type Nut  
4.8mm (#10) Screw Size  
Panel Range: .5mm-1.7mm  
Center of Hole to Edge: 7mm  
UNIT PACKAGE: 50

**BMW (Cont.)**



**20985**  
(07129-925-734)  
Zinc

"U" Type Nut  
M4.8 (#10) Screw Size  
Panel Range: 2.5mm - 3.75mm  
Center of Hole to Edge: 8mm  
Series 3, 7, 8 & Z3  
1991 - On  
UNIT PACKAGE: 50



**13215**  
(BMW: 0711-9-916-945;  
Mercedes: 000-994-14-45)  
Plated

"U" Type Nut  
4.8mm (#10) Screw Size  
Panel Range: .8mm -1.7mm  
Center of Hole To Edge: 11mm  
UNIT PACKAGE: 50



**13162**  
(0712-9-925-720)  
Plated

"U" Type Nut  
5.6mm Screw Size  
Panel Range: 1.2mm -2.0mm  
Center of Hole To Edge: 10mm  
UNIT PACKAGE: 50



**13222**  
(Mercedes: 000-994-50-45;  
BMW: 0712-9-925-730;  
VW: N15.457.1;  
Opel: 20-72-175)  
Plated

"U" Type Nut  
6.5mm Screw Size  
Panel Range: .7mm-1.5mm  
Center of Hole To Edge: 13mm  
UNIT PACKAGE: 50

**FIAT**



**13196**  
(4-40-13-10)  
Red Nylon  
Moulding Clip  
UNIT PACKAGE: 50



**13197**  
(14-20-23-83 L125)  
Nylon  
Push-In-Nut  
UNIT PACKAGE: 50



**13198**  
(4-29-29-06)  
Black Nylon  
Interior Trim Retainer  
Head Dia: 16mm (41/64")  
Stem Dia: 9mm (11/32")  
Stem Length: 18mm (11/16")  
UNIT PACKAGE: 50

**GERMAN MADE  
FORD CLIPS  
& FASTENERS**



**12639**  
Nylon  
Body Side  
Moulding Clip  
w/Sealer  
UNIT PACKAGE: 25

FasTrack®  
 Auveco's Cost  
 Recovery System  
 For Repair Fasteners.

Never Lose Money On  
 Fasteners Again.



**19226**  
 (90157-SP0-901)  
 Nylon

Front Grille Clip  
 Acura Legend Coupe  
 1991 - On  
 Honda Odyssey 1995 - On

UNIT PACKAGE: 15



**17195**  
 (Isuzu: 8942180270)  
 Black Nylon

Grille Clip  
 13mm Wide  
 22mm Long  
 Ford Escort, Honda,  
 Isuzu, Mitsubishi & Plymouth Laser

UNIT PACKAGE: 25



**18457**  
 (91578-SV4-003)  
 Nylon

Radiator  
 Grille Clip  
 Accord  
 1994-On

UNIT PACKAGE: 5



**19439**  
 (90116-S82-A01)  
 Nylon

Left Rear Bumper  
 Fascia Clip  
 Accord  
 1998-On

UNIT PACKAGE: 5



**12576**  
 (90665-SA0-9700)  
 Nylon

Side Protector Moulding Clip  
 20mm Wide  
 41mm Long  
 Snaps Into 8mm Hole

UNIT PACKAGE: 10



**20603**  
 (Honda:  
 71592-S5D-000)  
 White Nylon

Bumper Retainer  
 With Sealer  
 Head Size: 20mm x 23mm x 15mm  
 Stem Length: 22mm  
 2001 - On

UNIT PACKAGE: 15



**20331**  
 (90108-SS0-003)  
 Black Nylon

Bumper Clip  
 35mm Wide  
 38mm High  
 Use with #8 Screw  
 Accord  
 1998 - On

UNIT PACKAGE: 5



**20677**  
 (71598-S30-013)  
 Black Nylon

Rear Bumper Moulding Clip  
 With Sealer  
 Width: 34mm  
 Length: 30mm

Overall Height: 31mm  
 Accord  
 1998 - On

UNIT PACKAGE: 5

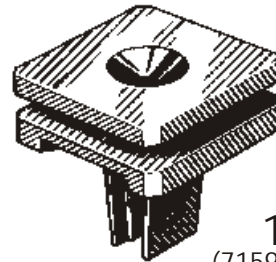

**18200**  
 (71593-SM4-0030)  
 Nylon

Bumper Retainer  
 Accord 1992-On

UNIT PACKAGE: 5



**19150**  
 (91509-SM4-000)  
 Natural Nylon

Bumper Grommet  
 Accord  
 1993-90

UNIT PACKAGE: 10



**15997**  
 (34355-SD2-003)  
 Nylon

Side Marker Clip  
 Accord  
 1986-On

UNIT PACKAGE: 25

# HONDA CLIPS & FASTENERS



**14306**  
(90675-692-0031)  
Nylon

Body Side  
Moulding Clip  
18mm Wide 15mm Long  
Snaps Into 10mm Hole

UNIT PACKAGE: 25



**20785**  
(75305-SH4-003)  
Red Nylon

Body Side Moulding Clip  
Head Size: 14mm x 15mm  
Stem Length: 14mm  
Civic  
1996 - On

UNIT PACKAGE: 10



**17270**  
(72413-SF1-0030)  
Nylon

Moulding Clip  
Prelude  
1988-On

UNIT PACKAGE: 15



**14308**  
(90679-692-0030)  
Nylon

Body Side Moulding Clip  
10mm Wide; 12mm Long  
Snaps Into 10mm Hole

UNIT PACKAGE: 25



**19737**  
(91515-SR4-003)  
Red Nylon

Side Moulding Clip  
Civic  
1995 - 92

UNIT PACKAGE: 10



**17443**  
(91534-SE0-000)  
Nylon

Body Side Moulding Clip  
Accord 1986-On

UNIT PACKAGE: 25



**20784**  
(75305-SH2-003)  
Blue Nylon

Body Side Moulding Clip  
Head Size: 12mm x 15mm  
Stem Length: 15mm  
Civic & CR-V  
1996 - On

UNIT PACKAGE: 10



**17981**  
(91510-SR3-003)  
Nylon

Belt Moulding Clip  
Civic  
1992-On

UNIT PACKAGE: 10



**20602**  
(75306-SV1-A01)  
White Nylon

Body Side Moulding Clip  
Head Size: 14mm x 14mm  
Stem Length: 14mm  
Accord 1998 - On

UNIT PACKAGE: 25

Please Order  
In Unit Package  
Quantities Not  
Number Of  
Pieces



**20272**  
(91589-SV4-003)  
Red Nylon

Belt Moulding Clip  
Width: 20mm  
Length: 24mm  
Accord  
1994 - On

UNIT PACKAGE: 25



**20783**  
(75305-S0A-003)  
White Nylon

Body Side Moulding Clip  
Head Size: 6.5mm & 13mm x 18mm  
Stem Length: 12mm  
Civic, CR-V, Odyssey & Pilot  
1999 - On

UNIT PACKAGE: 10



**21109**  
(75329-SH4-013)  
Red Nylon

Door Moulding Clip  
Head Size: 10mm x 12mm  
Stem Length: 13mm  
Accord  
1990 - On

UNIT PACKAGE: 15



**20737**  
(91562-S84-A01)  
Yellow Nylon

Belt Moulding Clip  
Width: 20mm  
Length: 27mm  
Accord  
1998 - On

UNIT PACKAGE: 10



**17442**

(90601-SH3-014)  
Nylon

Door Belt Moulding Clip  
Civic  
1988-On

UNIT PACKAGE: 10



**20340**

(91501-S5D-A01)  
White Nylon

Door Moulding Clip  
27mm Wide 40mm Long  
Civic  
2001 - On

UNIT PACKAGE: 15



**19359**

(91531-ST0-003)  
Nylon

Door Moulding Clip  
Civic  
2, 3 & 4 Door  
1995-On

UNIT PACKAGE: 10



**19415**

(91527-SM4-003, 91527-SZ3-003,  
91561-S84-A01)  
White Nylon

Belt Moulding Clip  
Accord & Odyssey  
1990-On

UNIT PACKAGE: 10



**19740**

(90666-SSO-003)  
White Nylon

Roof Moulding Clip  
Acura Integra & Legend  
Prelude  
1992 - On

UNIT PACKAGE: 10

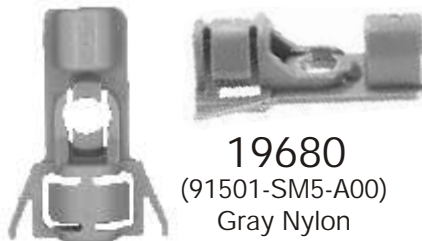

**19680**

(91501-SM5-A00)  
Gray Nylon

Roof Moulding Clip  
Odyssey  
1995 - On

UNIT PACKAGE: 10

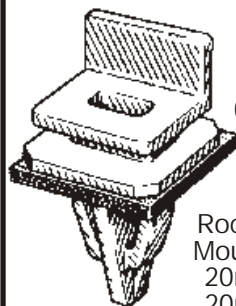

**17096**

(91513-SM4-000)  
Nylon

Rocker Panel  
Moulding Clip  
20mm Wide  
20mm Long  
Fits Into 12mm Hole  
Accord 1991-On

UNIT PACKAGE: 10



**17473**

(90611-SF1-003)  
Nylon

Quarter Window  
Moulding Clip  
Prelude  
1988-On

UNIT PACKAGE: 10



**17320**

(90612-AF1-003)  
Nylon

Window Reveal  
Moulding Clip  
Upper Quarter Glass  
Prelude  
1988-On

UNIT PACKAGE: 15

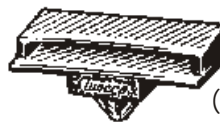

**17082**

(90610-SF1-003)  
Nylon

Rear Pillar  
Garnish Clip  
11mm Wide x 25mm Long  
Fits Into 6mm Hole  
Prelude 1988-On

UNIT PACKAGE: 15



**17089**

(90605-SF1-003)  
Nylon

Rear Pillar Garnish  
Moulding Clip  
11mm Wide, 25mm long  
Prelude 1988-On

UNIT PACKAGE: 10



**20782**

(75306-SDA-A01)  
White Nylon

Moulding Clip  
Head Size: 21mm x 27mm  
Stem Length: 11mm  
Accord  
2003 - On

UNIT PACKAGE: 10

# HONDA CLIPS & FASTENERS

Sec. 22



**19476**  
(91577-SV4-003)  
Red Nylon

Windshield Left-Hand Corner  
Moulding Clip  
Acura 2.2CL, 2.3CL & 3.0CL;  
Honda Accord & Odyssey  
1994-On

UNIT PACKAGE: 10



**19512**  
(91521-SR3-003)  
Purple Nylon

Windshield Side Moulding Clip  
Civic  
1995 - 92

UNIT PACKAGE: 10



**18865**  
(91529-SS0-003)  
Gray Nylon

Windshield Moulding Clip  
Prelude  
1992-On

UNIT PACKAGE: 15



**19477**  
(91576-SV4-003)  
Green Nylon

Windshield Right-Hand Corner  
Moulding Clip  
Acura 2.2CL, 2.3CL & 3.0CL;  
Honda Accord & Odyssey  
1994-On

UNIT PACKAGE: 10



**19513**  
(91519-SR3-003)  
Green Nylon

Windshield Side Moulding Clip  
Civic  
1995 - 92

UNIT PACKAGE: 10

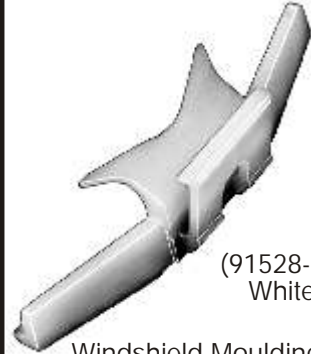

**18866**  
(91528-SS0-003)  
White Nylon

Windshield Moulding Clip  
Prelude  
1992-On

UNIT PACKAGE: 15

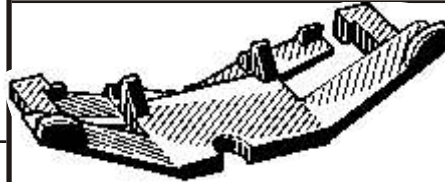

**18405**  
(91562-SV4-003)  
Yellow Nylon

Windshield Side Moulding Clip  
Accord 1994-On

UNIT PACKAGE: 5



**19478**  
(91574-SV2-003)  
Yellow Nylon

Windshield Moulding Clip  
Acura 2.2CL, 2.3CL & 3.0CL;  
Honda Accord  
1994-On

UNIT PACKAGE: 15



**18864**  
(91530-SS0-003)  
Black Nylon

Windshield Moulding Clip  
Prelude 1992-On

UNIT PACKAGE: 15



**18406**  
(91574-SV4-003)  
White Nylon

Windshield Side Moulding Clip  
Accord 1994-On

UNIT PACKAGE: 5

For the most  
up-to-date information  
on new items available  
from Auveco, refer to  
the "Hot New Items"  
section fo the  
Auveco web site  
([www.auveco.com](http://www.auveco.com))



**12580**  
(90674-692-0030)  
Black Nylon

Windshield Moulding Clip  
34mm Long, 16mm Wide  
Includes Adhesive  
Mounting Pads  
UNIT PACKAGE: 10



Not Actual Size  
**14685**  
(90683-SC6-0030;  
90683-SA6-0030)  
Gray Nylon

Windshield Moulding Clip  
60mm Long, 14mm Wide  
Includes Adhesive  
Mounting Pads  
UNIT PACKAGE: 10



**21096**  
(91571-SDA-A01)  
White Nylon

Windshield Moulding Clip  
Width: 16mm  
Length: 75mm  
Accord 2003 - On  
UNIT PACKAGE: 10



**14701**  
(90658-SB0-0030)  
Black Nylon

Windshield Moulding Clip  
34mm Long, 17mm Wide  
Includes Adhesive  
Mounting Pads  
UNIT PACKAGE: 10



**19223**  
(91511-SR2-004)  
Yellow Nylon

Windshield  
Side Moulding Clip  
Del Sol  
1993-On  
UNIT PACKAGE: 10



**20385**  
(91519-S5P-A01)  
Blue Nylon

Windshield Moulding Clip  
17mm Wide, 65mm Long  
Upper Area Of Windshield  
Civic Coupe  
2001 - On  
UNIT PACKAGE: 10



**17285**  
(91525-SM4-003)  
Pink Nylon

Windshield Side Moulding Clip  
Use With 17286  
Accord 1990-On  
UNIT PACKAGE: 15

FasTrack®  
Auveco's Cost  
Recovery System  
For Repair Fasteners...  
Never Lose Money On  
Fasteners Again!



**21095**  
(91570-SDA-A01)  
Blue Nylon

Windshield Moulding Clip  
Width: 15mm  
Length: 76mm  
Accord 2003 - On  
UNIT PACKAGE: 10



**20387**  
(91519-S5A-003)  
Black Nylon

Windshield Moulding Clip  
17mm Wide, 50mm Long  
Upper Area Of Windshield  
Civic Coupe  
2001 - On  
UNIT PACKAGE: 10



**20386**  
(91520-S5A-003)  
White Nylon

Windshield Moulding Clip  
23mm Wide, 63mm Long  
Lower Area Of Windshield  
Civic Sedan  
2001 - On

UNIT PACKAGE: 10



**17286**  
(91524-SM4-A11)  
Yellow Nylon

Windshield Side Moulding Clip  
Use With 17285  
Accord 1990-On

UNIT PACKAGE: 15



**17474**  
(91511-SR3-003)  
Orange Nylon

Windshield Side Moulding Clip  
Use With 17475  
Civic 1992-On

UNIT PACKAGE: 15

Body Hardware  
&  
Specialty Fasteners  
= Auveco



**19670**  
(91541-SM4-003,  
91542-SP0-003)  
Aqua Nylon  
Rear Window  
Adjustable Moulding Clip  
Accord  
1990 - On

UNIT PACKAGE: 10



**21094**  
(91572-SDA-A01)  
White Nylon

Windshield Moulding Clip  
Width: 14mm  
Length: 62mm  
Accord 2003 - On  
Civic 2006 - On

UNIT PACKAGE: 10



**19224**  
(91572-SV2-003)  
Natural Nylon

Windshield  
Side Moulding Clip  
Accord 1997-94

UNIT PACKAGE: 10



**17475**  
(91520-SR3-003)  
Red Nylon

Windshield Side Moulding Clip  
Use With 17474  
Civic 1992-On

UNIT PACKAGE: 15

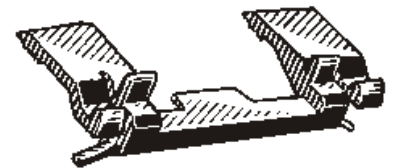

**18403**  
(91573-SV4-003)  
Teal Nylon

Windshield Side Moulding Clip

Accord 1994-On

UNIT PACKAGE: 10

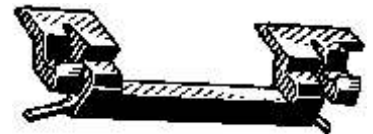

**18404**  
(91572-SV4-003)  
Pink Nylon

Windshield Side Moulding Clip  
Use With 17324  
Accord 1994-On

UNIT PACKAGE: 10

All Items Are  
Available In Bulk.  
Call For A Quotation.



14705

(90713-SB0-003)  
Black Nylon

Quarter Window  
Moulding Clip  
18mm Long  
18mm Wide  
Snaps Into 5mm Hole

UNIT PACKAGE: 25



15472

(90664-SB0-004)  
Black Nylon

Windshield Moulding Clip  
11mm Wide, 35mm Long  
Honda 1983-On

UNIT PACKAGE: 15



17281

(90694-SB0-003)  
Black Nylon

Windshield Moulding Clip  
Prelude 1983-On

UNIT PACKAGE: 15



14700

(90672-SA6-0030)  
Black Nylon

Windshield Moulding Clip  
35mm Long  
14mm Wide

UNIT PACKAGE: 25



17454

(74807-SB0-004)  
Black Nylon

Rear Window Moulding Clip  
1983-On

UNIT PACKAGE: 25



17282

(91534-SM4-003)  
White Nylon

Windshield Moulding Clip  
Accord 1990-On  
Acura Legend 1991-On

UNIT PACKAGE: 10



14703

(90673-SC6-0030)  
White Nylon

Windshield Moulding Clip  
35mm Long  
14mm Wide

UNIT PACKAGE: 25



15474

(90674-SC6-003)  
Black Nylon

Back Glass Moulding Clip  
15mm Wide, 38mm Long  
Accord 1984-On

UNIT PACKAGE: 15



17321

(90606-SF1-003)  
White Nylon

Window Reveal Moulding Clip  
Lower Quarter Glass  
Prelude 1988-On

UNIT PACKAGE: 10

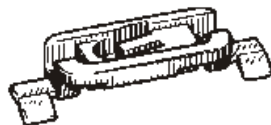

17280

(91505-SG0-003)  
Orange Nylon

Windshield Moulding Clip  
Prelude 1988-On  
Acura Legend 1988-On

UNIT PACKAGE: 15



19115

(91528-S01-A01)  
Blue Nylon

Drip Moulding Clip  
4 Door Civic  
1995-On

UNIT PACKAGE: 15

Please Order  
In Unit Package  
Quantities Not  
Pieces



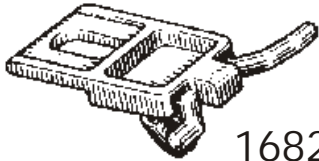

**16825**  
(74806-SB6-003)  
White Nylon

Back Glass Moulding Clip  
33mm Wide, 30mm Long  
Snaps Into 6mm Hole  
Civic, Hatchback 1984-On

UNIT PACKAGE: 25



**16861**  
(90664-692-0300)  
Black Nylon

Windshield Reveal Moulding Clip  
40mm Wide, 40mm Long  
Prelude 1979-On

UNIT PACKAGE: 25

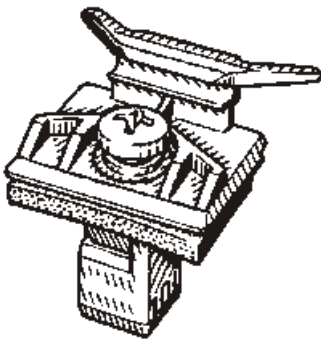

**17203**  
(91526-SM4-004)  
Black Nylon

w/ Stainless Steel Screw  
Windshield & Rear Window  
Holder Clip  
Accord 1990-On

UNIT PACKAGE: 5

Remember...  
All Items In This  
Catalog  
Are Available In Bulk.  
Call For A Quote

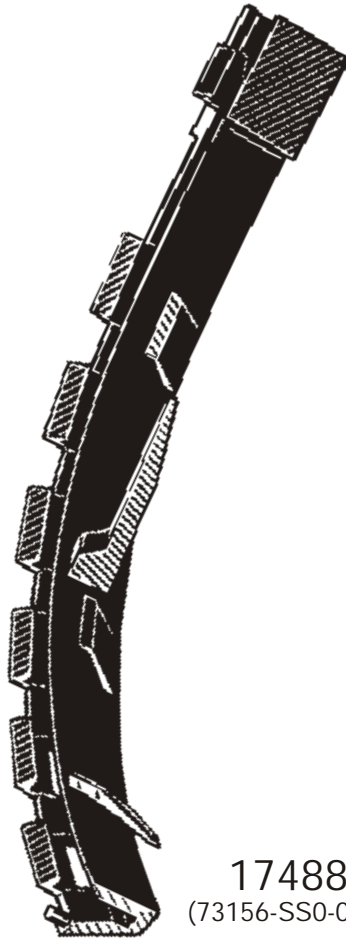

**17488**  
(73156-SS0-004)

Window Moulding Clip  
Left-Hand Corner  
Prelude  
1992-On

UNIT PACKAGE: 5



**14288**  
(90655-SAO-0030)  
Natural Nylon

#6 Screw Size  
9.5mm Wide; 9.5mm Long  
Snaps Into 6mm x 6mm Hole

UNIT PACKAGE: 50



**14317**  
(34301-692A-0000)  
White Nylon

#8 Screw Size  
9.5mm Wide; 9.5mm Long  
Snaps Into 6mm x 6mm Hole

UNIT PACKAGE: 50



**14255**  
(Honda: 75522-611-0000;  
Mazda: 9991-00-412;  
Mitsubishi: MS-480001)  
Black Nylon

#8 Screw Size  
9.5mm Wide, 9.5mm Long  
Snaps Into 7mm x 7mm Hole

UNIT PACKAGE: 50



**20350**  
(90866-SAO-000)  
Natural Nylon

Door Trim  
Nylon Nut  
#4 Screw Size  
Head Size: 13mm x 13mm  
Stem Length: 7mm  
Civic  
1998 - On

UNIT PACKAGE: 25



**20351**  
(90666-SD9-000)  
Natural Nylon

Nylon Nut  
#14 (M6.3) Screw Size  
Head Size: 16mm x 16mm  
Stem Length: 8mm  
CR-V  
1997 - On

UNIT PACKAGE: 25

Visit The Auveco  
Web Site At  
[www.auveco.com](http://www.auveco.com)



**17058**

(90676-SA7-003)  
Natural Nylon

Headlight Adjusting  
Screw Nut  
M5-.8 Screw Size  
Prelude & Accord 1986-On

UNIT PACKAGE: 25



**14274**

(Honda: 75521-611-0000;  
Mazda: 9991-00-601;  
Nissan: 96706-P0105  
Toyota: 90189-06010)  
Natural Nylon

#10 Screw Size  
13mm Wide, 13mm Long  
Snaps Into 8.5mm x  
8.5mm Hole

UNIT PACKAGE: 25



**20445**

(91637-SE3-003)  
Natural Nylon

Trim Pillar Garnish  
Screw Grommet  
M3.5 (#6) Screw Size  
Head Size: 13mm x 17  
CR-V  
1997 - On

UNIT PACKAGE: 15



**14287**

(90656-671-6310M1)  
Natural Nylon

#14 (1/4") Screw Size  
13mm Wide, 15mm Long  
Snaps Into 8.5mm x 10.5mm Hole

UNIT PACKAGE: 50



**19117**

(91619-SM4-003,  
91619-SM4-0030)  
Natural Nylon

Center Pillar Garnish  
Moulding (Oval) Screw Grommet  
#4 Screw Size  
Odyssey & Accord Wagon  
1991-On

UNIT PACKAGE: 25



**20612**

(90603-S7S-003)  
Blue Nylon  
With Sealer

Cowl Vent Grommet  
Flange Size: 10mm x 24mm  
Stem Length: 6mm  
Use With Auveco 20611  
Accord  
2003 - On

UNIT PACKAGE: 15



**14294**

(90675-SA6-0030)  
Natural Nylon

Screw Grommet  
With Sealer  
#6 Screw Size  
15mm Wide, 15mm Long  
Stem Length: 12mm  
Snaps Into 7mm x 7mm Hole

UNIT PACKAGE: 15



**14313**

(Honda: 90662-671-0030;  
Mazda: 9991-00-503;  
Nissan: 68425-H5000)  
Natural Nylon

#10 Screw Size  
17mm Wide  
17mm Long  
Snaps Into 8mm x 8.5mm Hole  
Also For Mazda & Nissan

UNIT PACKAGE: 25



**14280**

(90681-693-0000)  
Natural Nylon

Screw Grommet  
#6 Screw Size  
10mm Wide 17mm Long  
Stem Length: 15mm  
Fits Into 7mm x 13mm Hole

UNIT PACKAGE: 25



**14296**

(90668-688-0030)  
Natural Nylon

Screw Grommet  
With Sealer  
#6 Screw Size  
11mm Wide, 14mm Long  
Stem Length: 10mm  
Snaps Into 7mm x 10mm Hole

UNIT PACKAGE: 25

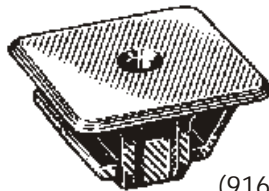

**17609**

(91635-SM4-003)  
Black Nylon

Headlight To Grille  
Spacer Bracket Grommet  
#10 Screw Size  
Accord  
1990-On

UNIT PACKAGE: 10



**14690**

(Honda: 90683-693-0000;  
Nissan: 78856-R4301)  
White Nylon

Screw Grommet  
#10 Screw Size  
12mm Wide  
19mm Long  
Stem Length: 17mm  
Fits Into 8mm x 15mm Hole

UNIT PACKAGE: 25



**19679**  
(91641-SH3-013)  
Yellow Nylon  
w/ Steel Insert

Garnish Moulding Grommet  
Head Diameter: 14mm x 26mm  
Acura Integra, Honda Civic  
& Prelude  
1988 - On

UNIT PACKAGE: 10



**14281**  
(Honda: 90662-693-0030;  
Toyota: 9018-04066)  
White Nylon

Screw Grommet  
#6 Screw Size  
Head Diameter: 14mm  
Stem Length: 10mm  
Fits Into 7mm x 7mm Hole

UNIT PACKAGE: 25



**20303**  
(90664-SB3-003)  
Natural Nylon

Trim Panel  
Screw Grommet  
#8 (M4.2) Screw Size  
Head Diameter: 15mm  
Stem Length: 15mm  
Fits Into 8mm x 8mm Hole  
Accord  
1998 - On

UNIT PACKAGE: 10



**19307**  
(91620-SR2-003)  
Natural Nylon

Center Pillar  
Screw Grommet  
#4 Screw Size  
Del Sol  
1993-On

UNIT PACKAGE: 10



**19741**  
(90670-SG0-003,  
91626-SH3-003)  
Natural Nylon

Door Panel Screw Grommet  
#8 (M4.2) Screw Size  
Head Diameter: 12mm  
Stem Length: 16mm  
Fits Into 7mm x 7mm Hole  
Civic & CR-V  
1993-On

UNIT PACKAGE: 15



**20954**  
(90682-SEA-003)  
Black Nylon

Fender Apron Screw Grommet  
#8 (M4.2) Screw Size  
Head Diameter: 20mm  
Stem Length: 12mm  
Fits Into 9mm Square Hole  
Acura TSX and  
Honda Civic & Odyssey  
2004 - On

UNIT PACKAGE: 25



**19646**  
(90665-SM4-000)  
Yellow Nylon

Front Door  
Screw Grommet  
#6 Screw Size  
Head Diameter: 14mm  
Stem Length: 10mm  
Fits Into 7mm x 7mm Hole  
Prelude  
1997 - On

UNIT PACKAGE: 15



**14695**  
(Honda: 90661-SC7-0030;  
Mazda: H001-50-841;  
Mitsubishi: MS-480012;  
Nissan: 01651-00481, 74798-S9000;  
Toyota: 90189-06042)  
White Nylon

Screw Grommet  
#8 (M4.2) Screw Size  
Head Diameter: 16mm  
Stem Length: 17mm  
Fits Into 8mm x 8mm Hole

UNIT PACKAGE: 25



**19650**  
(90106-SW3-003)  
White Nylon

Bumper Grommet  
Head Size: 18mm x 20mm  
Stem Length 19mm  
Fits Into 8mm x 11mm Hole  
Accord, Odyssey  
& Prelude  
1995 - On

UNIT PACKAGE: 10



**14268**  
(Honda: 90672-671-8110M1;  
Toyota: 90189-04013)  
White Nylon

Screw Grommet  
#6 Screw Size  
Head Diameter: 14mm  
Stem Length: 15mm  
Fits Into 7mm x 7mm Hole

UNIT PACKAGE: 25



**19143**  
(91623-SM2-0030)  
Natural Nylon

Door Glass  
Guide Grommet  
#6 Screw Size  
Prelude &  
2 Door Accord  
1990-On

UNIT PACKAGE: 10



**19533**  
(90107-S10-003)  
Black Nylon

Wheel Well Moulding  
Screw Grommet  
#10 Screw Size  
CR-V  
1997 - On

UNIT PACKAGE: 25



**14291**  
(66435-648-0000)  
Black Nylon

Retaining Clip  
Head Diameter: 11mm  
Stem Length: 13mm  
Snaps Into 5mm Hole  
Panel Thickness: 5mm

UNIT PACKAGE: 50



**19454**  
(90651-SL9-0130)  
Gray Nylon

Rear Bumper Fascia  
Grommet  
#8 (M4.2) Screw Size  
Accord  
1996 - 94

UNIT PACKAGE: 15



**20472**  
(91512-SR3-004)  
White Nylon

Tubular Nut  
With Sealer & Sealed End  
3mm Stud Size  
Head Dia: 8.5mm  
Fits Into 6mm Hole  
Emblem Nut  
Acura Integra,  
Honda Accord, Civic, CR-V  
& Prelude  
1994 - On

UNIT PACKAGE: 10



**14282**  
(90687-SA5-0030)  
Black Nylon

Retaining Clip  
Head Diameter: 13mm  
Stem Length: 15mm  
Snaps Into 5mm Hole  
Panel Thickness: 4mm

UNIT PACKAGE: 50



**19734**  
(90107-SX0-003)  
Black Nylon

Bumper Grommet  
#10 Screw Size  
Acura 2.2CL, 2.3CL, 2.5TL,  
3.2TL, & 3.5RL;  
Honda Accord & Prelude  
1996 - On

UNIT PACKAGE: 15



**17283**  
(90655-SB2-003)  
Nylon

Cowl Vent & Interior  
Trim Panel Retainer  
Civic 1984-On

UNIT PACKAGE: 25



**18157**  
(90672-671-003)  
Gray Nylon

Headliner & Cowl Grille  
Retaining Clip  
Head Diameter: 13mm  
Stem Length: 16mm  
Panel Thickness: 5mm  
Fits Into 5mm Hole  
Accord 1986-On

UNIT PACKAGE: 25



**18415**  
(71144-SR3-A00)  
Natural Nylon

Bumper Grommet  
M4.2 (#8) Screw Size  
Civic  
1993-On

UNIT PACKAGE: 25



**18115**  
(90676-SR4-003)  
Nylon

Reveal Moulding  
Pin Retainer  
Civic 1993-On

UNIT PACKAGE: 15



**20381**  
(Honda: 90667-671-013ZA;  
Mitsubishi: MC440901;  
Nissan: 62660-48600-1)  
Black Nylon

Trim Panel Retaining Clip  
Head Diameter: 16mm  
Stem Diameter: 7mm  
Stem Length: 16mm  
Honda, Mitsubishi & Nissan

UNIT PACKAGE: 25



**20882**  
(91501-SEA-003)  
Black Nylon

Cowl & Garnish Retainer  
Head Diameter: 20mm  
Stem Diameter: 7mm  
Stem Length: 15mm  
Civic  
2006 - On

UNIT PACKAGE: 10



**19470**  
(90108-SW3-003)  
Black Nylon

Bumper Retainer  
Head Diameter: 16mm  
Stem Diameter: 4mm  
Stem Length: 21mm  
Accord,  
Odyssey & Prelude  
1995-On

UNIT PACKAGE: 15



**16776**  
(Honda: 90667-SAO-0030;  
Nissan: 76996-01P02)  
Black Nylon

Trim Panel Retainer  
Head Dia: 18mm  
Stem Length: 20mm  
Fits Into 6mm Hole

UNIT PACKAGE: 25



**20334**  
(90667-SOD-003ZC)  
Black Nylon

Trunk Garnish Retainer  
Head Dia: 18mm  
Stem Dia: 7.5mm Sq.  
Stem Length: 20mm  
Civic  
1998 - On

UNIT PACKAGE: 15



**19506**  
(90666-SA7-003ZW)  
Black Nylon

Trunk Lining Retainer  
Head Diameter: 16mm  
Stem Diameter: 5mm Square  
Stem Length: 16mm  
Acura 2.5TL, 3.2TL, 3.5,  
Integra & Legend,  
Honda Accord Wagon  
& Prelude  
1987 - On

UNIT PACKAGE: 15



**15998**  
(90700-SB2-003)  
Black Nylon

Hood Insulation Retainer  
Head Dia: 30mm  
Stem Length: 9mm  
Fits Into 6mm Hole  
Honda Prelude 1985-On

UNIT PACKAGE: 15



**16781**  
(Honda: 90670-692-0030;  
Toyota: 90467-09065)  
Black Nylon

Retaining Clips  
Head Dia: 15mm  
Stem Length: 20mm  
Panel Thickness: 11mm  
Fits Into 7mm Hole

UNIT PACKAGE: 25



**19744**  
(90669-SP0-003ZA)  
Black Nylon

Trunk Trim Retainer  
Head Diameter: 16mm  
Stem Diameter: 6mm  
Stem Length: 27mm  
Civic  
1998 - On

UNIT PACKAGE: 10



**18746**  
(90700-SJ4-000)  
Black Nylon

Hood Insulation Retainer  
Head Diameter: 30mm  
Stem Diameter: 15mm x 18mm  
Stem Length: 6mm  
Acura Legend 1991 - On  
Honda 1998 - On

UNIT PACKAGE: 15



**14289**  
(90666-SAO-0030)  
Black Nylon

Retainer  
Head Diameter: 13mm  
Stem Length: 16mm  
Snaps Into 5mm Hole

UNIT PACKAGE: 25



**16775**  
(Honda: 90667-SA7-0030;  
Nissan: 89427-98070)  
Black Nylon

Trim Panel Retainer  
Head Dia: 20mm  
Stem Length: 15mm  
Fits Into 5mm Hole

UNIT PACKAGE: 25



**20609**  
(91501-S1K-003)  
Black Nylon

Hood Insulation Retainer  
Head Diameter: 30mm  
Stem Diameter: 15mm x 20mm  
Stem Length: 14mm  
Acura 3.5RL & RSX And  
Honda Civic & CR-V  
2000 - On

UNIT PACKAGE: 25



**18114**

(91520-SM4-C010)  
Black Nylon

Hood Insulation Retaining Clip  
Head Diameter: 10mm  
Stem Length: 10mm  
Panel Thickness: 4mm  
Fits Into 6mm Hole  
Honda & Acura 1990-On  
UNIT PACKAGE: 25



**14323**

(38529-689A-6300)  
Black Nylon

Retaining Clip  
Head Diameter: 18mm  
Stem Length: 15mm  
Snaps Into 7mm Hole  
Panel Thickness: 4mm  
UNIT PACKAGE: 25



**21107**

(90602-SX0-003)  
White Nylon

Cowl Vent Retainer  
Top Head Diameter: 12mm  
Bottom Head Diameter: 16mm  
Stem Diameter: 4mm  
Stem Length: 13mm  
Acura MDX, Honda Civic,  
Insight, Odyssey & Prelude  
1995 - On  
UNIT PACKAGE: 10



**19682**

(91518-S10-003)  
Black Nylon

Hood Seal Retaining Clip  
Head Diameter: 11mm  
Stem Length: 8mm  
Fits Into 6mm Hole  
Odyssey  
1999 - On  
UNIT PACKAGE: 25



**16779**

(Honda: 74842-659-0030;  
Toyota: 90467-12078)  
Black Nylon

Retaining Clip  
Head Dia: 18mm  
Stem Length: 15mm  
Panel Thickness: 6mm  
Fits Into 8mm Hole  
UNIT PACKAGE: 25



**19145**

(91560-SP0-003)  
Gray Nylon

Front & Rear Door  
Trim Panel Retainer  
Small Head Dia: 13mm  
Large Head Dia: 17mm  
Stem Diameter: 9mm  
Stem Length: 12mm  
Acura Integra & Legend  
Honda Accord, Civic,  
Prelude, Odyssey & Del Sol  
1991-On  
UNIT PACKAGE: 25



**19114**

(91518-SM4-003)  
Black Nylon

Hood & Trunk Moulding  
Retaining Clip  
Head Diameter: 12mm  
Stem Length: 9mm  
Fits Into 6mm Hole  
Acura Integra & Honda Civic  
1994 - On  
UNIT PACKAGE: 10



**14319**

(90687-671-0030)  
Black Nylon

Retaining Clip  
Head Diameter: 20mm  
Stem Length: 20mm  
Snaps Into 10mm Hole  
Panel Thickness: 6mm  
UNIT PACKAGE: 25



**20411**

(91560-S84-A11)  
Black Nylon

Windshield Garnish  
Pillar Retainer  
Top Head Dia: 13mm  
Middle Head Dia: 16mm  
Bottom Head Dia: 14.5mm  
Stem Diameter: 9.5mm  
Stem Length: 12mm  
Acura 3.2CL, Honda Accord,  
Insight & Odyssey  
1998 - On  
UNIT PACKAGE: 15



**17205**

(91501-SM4-003)  
Black Nylon

Cowl Top Retaining Clip  
Head Dia: 14mm  
Stem Length: 15mm  
Fits Into 6mm Hole  
Accord 1990-On  
UNIT PACKAGE: 15



**20611**

(90602-S7S-003)  
Blue Nylon

Cowl Vent Retainer  
Top Head Diameter: 12mm  
Bottom Head Diameter: 16mm  
Stem Diameter: 3mm  
Stem Length: 7mm  
Use With Auveco 20612  
Accord  
2003 - On  
UNIT PACKAGE: 25

You Can E-Mail  
Your New Item  
Suggestions  
To [mail@auveco.com](mailto:mail@auveco.com)



**20959**  
(91560-S9A-A01)  
Blue Nylon

Door Panel Retainer  
Top Head Diameter: 13mm  
Middle Head Diameter: 16mm  
Bottom Head Diameter: 15mm  
Stem Diameter: 9.5mm  
Stem Length: 13mm  
Acura TL & TSX and  
Honda Accord, Civic, CR-V  
& Odyssey  
2002 - On

UNIT PACKAGE: 25



**21087**  
(90602-SAA-003)  
Orange Nylon

Cowl Vent &  
Radiator Support Retainer  
Top Head Diameter: 12mm  
Middle Head Diameter: 16mm  
Bottom Head Diameter: 18mm  
Stem Diameter: 9.7mm  
Stem Length: 14mm  
Fit & CR-V  
2003 - On

UNIT PACKAGE: 15



**20610**  
(Honda: 91560-SM4-003)  
White Nylon

Door Trim Panel Retainer  
Top Head Diameter: 13mm  
Middle Head Diameter: 18mm  
Bottom Head Diameter: 16mm  
Stem Diameter: 9mm  
Stem Length: 15mm  
Accord  
1990 - On

UNIT PACKAGE: 25



**18294**  
(91566-SP0-003)  
White Nylon

Trim Panel Retainer  
Small Head Dia: 13mm  
Large Head Dia: 18mm  
Stem Length: 14mm  
Fits Into 9mm Hole  
Honda 1990-On

UNIT PACKAGE: 15



**21059**  
(90602-S5A-003)  
Blue Nylon

Cowl Vent Retainer  
Top Head: 12mm x 13mm  
Middle Head Diameter: 16mm  
Bottom Head Diameter: 18mm  
Stem Diameter: 8.5mm x 8.5mm  
Stem Length: 14mm  
Acura RSX and  
Honda Civic & CR-V  
2001 - On

UNIT PACKAGE: 15



**14299**  
(73862-672-0030)  
White Nylon

Weatherstrip Retainer  
7mm Wide  
16mm Long  
Stem Length: 5mm  
Fits Into 5mm Hole

UNIT PACKAGE: 50



**14328**  
(90664-671-0030)  
White Nylon

Weatherstrip Retainer  
7mm Wide  
16mm Long  
Stem Length: 10mm  
Fits Into 5mm Hole

UNIT PACKAGE: 50



**19673**  
(72311-S10-003)  
Black Nylon

Weatherstrip Retainer  
Head Size: 10mm x 15mm  
Stem Diameter: 5mm  
Stem Length: 10mm  
CR-V  
1997 - On

UNIT PACKAGE: 15



**18818**  
(91513-SE0-003)  
Natural Nylon

Hood Seal Retainer  
Head Size: 7mm x 16mm  
Stem Length: 12mm  
Fits Into 5mm Hole  
Accord & Prelude  
1983-On

UNIT PACKAGE: 25



**18877**  
(91530-SP1-003)  
Red Nylon

Weatherstrip Retainer  
Head Size: 5mm x 15mm  
Stem Length: 10mm  
Fits Into 6mm Hole  
Acura 3.5 RL & Honda  
Accord, Civic & Odyssey  
1992-On

UNIT PACKAGE: 25



**19116**  
(91530-ST5-003)  
Natural Nylon

Weatherstrip Retainer  
Head Size: 5mm x 15mm  
Stem Length: 10mm  
Fits Into 6mm Hole  
Front & Rear Doors  
Civic  
1995 - On

UNIT PACKAGE: 10



**19171**  
(91568-SR2-003)  
Green Nylon

Weatherstrip Retainer  
Head Size: 5mm x 15mm  
Stem Length: 10mm  
Fits Into 5mm Hole  
Odyssey  
1995 - On

UNIT PACKAGE: 100



**19683**  
(91502-S84-A11)  
Black Nylon

Cowl Vent  
Retaining Clip  
Head Diameter: 6mm x 16mm  
Stem Length: 14mm  
Fits Into 6mm Hole  
Odyssey  
1999 - On

UNIT PACKAGE: 15



**19483**  
(91515-SR3-000)  
Black Nylon

Rear Hood Cowl  
Weatherstrip Retaining Clip  
Head Size: 8mm x 18mm  
Stem Length: 15mm  
Fits Into 7mm Hole  
Acura Integra, Honda Civic, CR-V  
& Del Sol  
1992 - On

UNIT PACKAGE: 25



**14290**  
(90692-SA5-0030)  
Black Nylon

Niflock Rivet  
Diameter: 5mm  
Head Diameter: 12mm  
Stem Length: 17mm

UNIT PACKAGE: 25



**14293**  
(90674-SA5-0030)  
Black Nylon

Niflock Rivet  
Diameter: 6mm  
Head Diameter: 11mm  
Stem Length: 23mm

UNIT PACKAGE: 25



**19186**  
(90657-SB0-003)  
Black Nylon

Front Bumper Cover  
Push-Type Retainer  
Head Diameter: 11mm  
Stem Length: 10mm  
Fits Into 8mm Hole  
Acura Legend, Honda Accord &  
Odyssey  
1991-On

UNIT PACKAGE: 10



**19547**  
(91508-S50-003)  
Black Nylon

Cowl Top Retainer  
Head Diameter: 17mm  
Stem Length: 13mm (Exc. Pin)  
Fits Into 9mm Hole  
Accord & Odyssey  
1998 - On

UNIT PACKAGE: 5



**18165**  
(91508-SR3-000)  
Black Nylon

Cowl Panel  
Push-Type Retainer  
Head Diameter: 17mm  
Stem Length: 9mm  
Fits Into 8mm Hole  
Honda 1990-On

UNIT PACKAGE: 10



**20247**  
(Mitsubishi: MR200300)  
Black Nylon

Fender & Bumper  
Push-Type Retainer  
Head Diameter: 18mm  
Stem Length: 12mm  
Fits Into 9mm Hole  
Honda & Mitsubishi  
1998 - On

UNIT PACKAGE: 15



**17192**  
(91508-SM4-003)  
Black Nylon

Cowl Panel Push-Type Retainer  
Head Dia: 18mm  
Stem Length: 14mm  
Fits Into 8mm Hole  
Accord 1990-On

UNIT PACKAGE: 10



**19453**  
(90505-SX0-003)  
Black Nylon

Garnish Side Protector  
Push-Type Retainer  
Head Diameter: 18mm  
Stem Length: 15mm  
(Not Including The Pin)  
Fits Into 8mm Hole  
Odyssey  
1995 - On

UNIT PACKAGE: 15



**19118**  
(91501-S04-003)  
Black Nylon

Front Fender  
Push-Type Retainer  
Head Diameter: 20mm  
Stem Length: 10mm  
Fits Into 8mm Hole  
Civic & Del Sol 1993-On

UNIT PACKAGE: 15





**19233**  
 (Honda: 91503-SZ3-003;  
 Black Nylon  
 Front Bumper Push-Type Retainer  
 Head Diameter: 20mm  
 Stem Length: 13mm  
 Fits Into 10mm Hole  
 Acura 3.5 RL Sedan & Honda  
 1996-On  
 UNIT PACKAGE: 15



**20608**  
 (91503-S0K-A01)  
 Black Nylon  
 Grille Mounting  
 Push-Type Retainer  
 Head Diameter: 20mm  
 Stem Length: 14mm  
 Fits Into 10mm Hole  
 Element  
 2003 - On  
 UNIT PACKAGE: 15



**19416**  
 (Toyota: 90467-09139)  
 Black Nylon  
 Bumper Cover & Wheel Housing  
 Push-Type Retainer  
 Head Diameter: 18mm  
 Stem Length: 15mm  
 Fits Into 9mm Hole  
 Honda, Mazda 626 & Toyota Corolla  
 1992-On  
 UNIT PACKAGE: 15



**20986**  
 (91505-S9A-003)  
 Black Nylon  
 Front Bumper  
 Push-Type Retainer  
 With Internal Metal Insert  
 Head Diameter: 20mm  
 Stem Length: 13mm  
 Fits Into 10mm Hole  
 Civic  
 2006 - On  
 UNIT PACKAGE: 10



**20564**  
 (91503-SZ5-003)  
 Black Nylon  
 Front & Rear Bumper  
 Push-Type Retainer  
 Head Diameter: 20mm  
 Stem Length: 18mm  
 Fits Into 10mm Hole  
 Acura 3.5RL And  
 Honda Accord & Odyssey  
 1996 - On  
 UNIT PACKAGE: 15



**16782**  
 (Honda:  
 91545-SE0-0030-W1;  
 Nissan: 63848-01G00)  
 Black Nylon  
 Push-Type Retainer  
 Head Dia: 20mm  
 Stem Length: 14mm  
 Fits Into 8mm Hole  
 UNIT PACKAGE: 25



**19239**  
 (Honda:  
 91512-SX0-003;  
 Mitsubishi: MU000319)  
 Black Nylon  
 Front Fender & Bumper Support  
 Push-Type Retainer  
 Head Diameter: 20mm  
 Stem Length: 11mm  
 Fits Into 8mm Hole  
 Acura 3.5RL, Honda Accord,  
 Prelude & Odyssey  
 1994-On  
 Mitsubishi Lancer  
 2002-On  
 UNIT PACKAGE: 25



**20910**  
 (91505-ST7-003ZA)  
 Black Nylon  
 Door Panel  
 Push-Type Retainer  
 Head Diameter: 17mm  
 Stem Length: 12mm  
 Fits Into 8mm Hole  
 CR-V and S2000  
 2000 - On  
 UNIT PACKAGE: 10



**14286**  
 (90673-692-0030)  
 Black Nylon  
 Push-Type Retainer  
 15mm Wide  
 20mm Long  
 Stem Length: 9mm  
 Fits Into 8mm x 11.5mm Hole  
 UNIT PACKAGE: 25



**17287**  
 (90687-SB0-003,  
 90687-SB0-013)  
 Black Nylon  
 Cowl Vent Panel Retainer  
 Head Dia: 13mm  
 Stem Length: 11mm  
 Fits Into 6mm Hole  
 Prelude 1983-On  
 UNIT PACKAGE: 25



**14697**

(GM: 94198687;  
Honda: 90657-SA6-0030;  
Mazda: N304-13-356-A)  
Black Nylon

Push-Type Retainer  
Head Dia: 14mm  
Stem Length: 11mm  
Fits Into 7mm Hole  
UNIT PACKAGE: 25



**20352**

(91561-S84-A00-M1)  
Black Nylon

Rear Panel Assembly  
Push-Type Retainer  
Head Diameter: 16mm  
Stem Length: 21mm  
Fits Into 8mm Hole

UNIT PACKAGE: 10



**17057**

(90505-SM4-003)  
Black Nylon

Push-Type Retainer  
Head Dia: 18mm  
Stem Length: 21mm  
Fits Into 8mm Hole  
Accord 1990-On

UNIT PACKAGE: 10



**14696**

(Honda: 90684-SA5-0030;  
Isuzu: 8942981190;  
Nissan: 10998-30880)  
Black Nylon

Push-Type Retainer  
Head Dia: 15mm  
Stem Length: 11mm  
Fits Into 6mm Hole  
UNIT PACKAGE: 25



**19546**

(91570-SK7-003ZF)  
Black Nylon

Tailgate Lining Retainer  
Head Dia.: 17mm  
Stem Length: 16mm  
Fits Into 7mm Square Hole  
Prelude  
1997 - On

UNIT PACKAGE: 10



**16000**

(Honda: 90675-SB3-003;  
Mazda: FB01-56-964;  
Nissan: 63876-95596)  
Black Nylon

Push-Type Retainer  
Head Dia: 20mm  
Stem Length: 9mm  
Fits Into 8mm Hole

UNIT PACKAGE: 25



**19311**

(90683-SA5-003)  
Black Nylon

Front Fender Skirt  
Push-Type Retainer  
Head Diameter: 15mm  
Stem Length: 13mm  
Fits Into 6mm Hole  
Prelude  
1996-92

UNIT PACKAGE: 15



**17081**

(91524-SE0-003)  
Black Nylon

Cowl Push-Type Retainer  
Head Dia: 18mm  
Stem Length: 12mm  
Fits Into 6mm Hole  
Accord 1986-On

UNIT PACKAGE: 25



**17379**

(91512-SM4-003)  
Black Nylon

Fender Splash Shield  
Push-Type Retainer  
Head Diameter: 20mm  
Stem Length: 9mm  
Fits Into 8mm Hole  
Accord 1990-On

UNIT PACKAGE: 10



**19142**

(91550-SH3-003)  
Black Nylon

Pillar Garnish, Side And  
Trunk Lining  
Push-Type Retainer  
Head Diameter: 15mm  
Stem Length: 13mm  
Fits Into 7mm Square Hole  
Civic, Accord Wagon  
& Del Sol  
1993-On

UNIT PACKAGE: 5



**14698**

(90688-SB0-003)  
Black Nylon

Push-Type  
Retainer  
Head Dia: 18mm  
Stem Length: 11mm  
Fits Into 6mm Hole

UNIT PACKAGE: 25

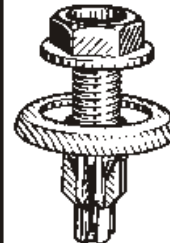

**17350**

(91516-SK7-013)  
Black Nylon

Splash Shield  
Push-Type Retainer  
Phillips Drive  
Head Dia: 20mm  
Stem Length: 15mm  
Fits Into 8mm Hole  
10mm Hex  
Civic 1992-On

UNIT PACKAGE: 10



**17144**  
(91504-SM4-000)  
Black Nylon

Push-Type Retainer  
Head Diameter: 20mm  
Stem Length: 24mm  
Fits Into 10mm Hole  
Bumper Fascia  
Accord 1990-On

UNIT PACKAGE: 10

**19408**

Same As 17144  
Except for packing

UNIT PACKAGE: 50



**18119**  
(91502-SP0-003)  
Black Nylon

Front & Rear Bumper  
Push-Type Retainer  
Head Diameter: 20mm  
Stem Length: 25mm  
Fits Into 10mm Hole  
Honda 1990-On

UNIT PACKAGE: 10



**17143**  
(91502-SM4-000)  
Black Nylon

Push-Type Retainer  
Head Diameter: 20mm  
Stem Length: 27mm  
Fits Into 10mm Hole  
Bumper Fascia  
Accord 1990-On

UNIT PACKAGE: 10

**19407**

Same as 17143  
Except for packing

UNIT PACKAGE: 50

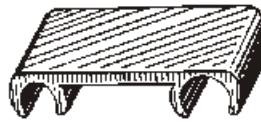

**14321**  
(17962-SA0-0030)  
Nylon

Tube/Cable Routing Clip  
One Cavity For  
5mm Tubes/Cables &  
One Cavity For  
7mm Tubes/Cables  
33mm Wide  
15mm Long

UNIT PACKAGE: 25

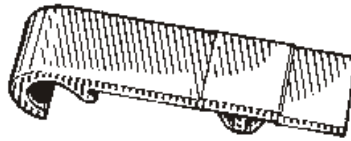

**18512**  
(91512-SE0-003)  
Gray Nylon

Windshield Washer Hose Clip  
11mm Wide, 42mm Long  
Holds 6.3mm (1/4") Hose  
Accord 1986-On

UNIT PACKAGE: 15

Not Actual Size



**20432**  
(91504-SR3-003)  
Black Nylon

Windshield Washer Hose Clip  
15mm Wide, 66mm Long  
Holds 6.3mm (1/4") Hose  
Accord, Civic,  
CR-V & Del Sol  
1993 - On

UNIT PACKAGE: 10



**14688**  
(91547-SE0-0030)  
Nylon

Hood Prop Rod Clip  
Holds 6mm Prop Rod  
Snaps Into 7mm Hole

UNIT PACKAGE: 25



**16949**  
(90652-SB2-023)  
Nylon

Windshield Washer  
Hose Retainer  
For 3mm (7/64") I.D.,  
5mm (13/64") O.D. Hose  
Fits Into 7mm (9/32")  
Square Hole

Honda 1986-On

UNIT PACKAGE: 15



**19672**  
(91558-SE3-003)  
Black Nylon

Wire Clip  
Maximum Wire Dia: 5mm  
For Hood Release Cable,  
Fuel Door Release Cable &  
Sliding Door Lock Cable  
Odyssey Van  
1999 - On

UNIT PACKAGE: 15

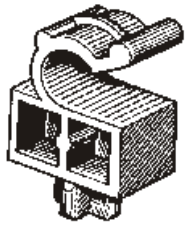

**14687**  
(90677-671-0031)  
Nylon

Hood Prop Rod Clip  
Holds 8mm Prop Rod  
Snaps Into 9mm x 9mm Hole

UNIT PACKAGE: 25



**18454**  
(91604-SD2-013)  
Nylon

Hood Prop Rod Grommet  
Civic 1989-On

UNIT PACKAGE: 5



Not Actual Size

**20380**  
Not Supplied  
By O.E.M.  
Black Nylon

Cable Strap  
Length: 200mm (8")  
5mm (3/16") Wide  
Max. Bundle Dia: 44mm (1-3/4")  
Fits Into 6.3mm (1/4") Hole  
Import Cars

UNIT PACKAGE: 25



**20330**  
(90602-S84-A01)  
Black Nylon

Hood Prop Rod Clip  
8mm Rod Diameter  
Accord  
1998 - On

UNIT PACKAGE: 10

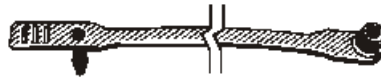

**14284**  
(Honda: 90669-671-0000,  
90669-671-0030;  
Toyota: 90463-10337)  
Nylon

Cable Strap  
Length: 110mm (5-5/16")  
Max. Bundle Dia.: 23mm  
Fits Into 6mm Hole

UNIT PACKAGE: 15



**17289**  
(60658-SB3-000)  
Nylon

Cowl Screen Screw Cover  
Head Dia: 17mm  
Fits Into 12mm Hole  
Civic 1984-On

UNIT PACKAGE: 25

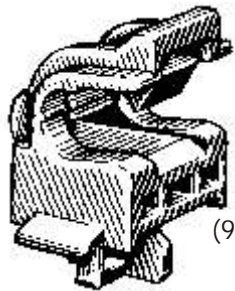

**16950**  
(90677-SE0-003)  
Nylon

Hood Prop  
Rod Clip  
Holds 8mm Prop Rod  
Accord 1986-On

UNIT PACKAGE: 5



Not Actual Size

**14298**  
(Honda: 90672-SA0-0030;  
Mazda: 9928-91-053)  
Nylon

Releasable Cable Strap  
Overall Length: 148mm (5-3/4")  
Max. Bundle Dia: 30mm  
Fits Into 7mm Hole

UNIT PACKAGE: 25



**16470**  
(90212-SA5-003)  
Zinc

M10-1.25  
Hex Flange Nut  
With Serrations  
20mm Flange O.D.

14mm Hex  
Class 10  
Used On Honda  
Exhaust Systems

UNIT PACKAGE: 25



**19730**  
(90654-SA4-003)  
Natural Nylon

Wire Routing Clip  
Holds 6mm Diameter Wire  
Fits Into 7mm Hole  
Civic  
1998 - On

UNIT PACKAGE: 15

Auveco Display Boards  
Are Great Selling Tools.  
Use Them To Help Boost  
Your Sales.  
Refer To The Color Pages  
At The Front Of The  
Catalog.

Please Order In Unit  
Package Quantities  
Not Number Of Pieces

**Honda (Cont'd)**



**20570**  
(Honda: 75307-SN7-000;  
Mini-Cooper: 07-13-0-702-715)  
Black Nylon

Nylon Moulding Nut  
With Brass Insert  
M4-0.7 Thread  
12mm Flange O.D.  
10mm Hex  
Height: 11mm  
1994 - On

UNIT PACKAGE: 15



**13225**  
Plated

"U" Type Nut  
4.2mm (#8) Screw Size  
11mm Wide  
16.5mm Long  
Panel Range: .5mm-2.5mm  
Center of Hole To Edge: 8mm

UNIT PACKAGE: 50

**HYUNDAI**



**21038**  
(87719-3D000)  
Natural Nylon

Body Side Moulding Clip  
Small Head: 6mm x 14mm  
Base Diameter: 14mm  
Overall Height: 6mm  
Elantra & Sonata  
2004 - On

UNIT PACKAGE: 15



**20566**  
(87756-3D000)  
White Nylon

Body Side Moulding Clip  
With Sealer  
Head Size: 14mm x 14mm  
Stem Length: 10mm  
M4.2 (#8) Screw Size  
Elantra & Sonata  
2002 - On

UNIT PACKAGE: 15



**20567**  
(87756-38000)  
Black Nylon

Body Side Moulding Clip  
With Sealer  
Small Head Size: 8mm x 9mm  
Large Head Size: 14mm x 18mm  
Stem Length: 10mm  
Elantra & Sonata  
2002 - On

UNIT PACKAGE: 15



**21064**  
(87758-35000)  
Yellow Nylon

Rocker Moulding Clip  
With Sealer  
Top Head Size: 10mm x 11mm  
Bottom Head Size: 14mm x 19mm  
Stem Length: 10mm  
Accent, Santa Fe & Tiburon  
1995 - On

UNIT PACKAGE: 15



**20568**  
(87758-3D000)  
Yellow Nylon

Rocker Panel Clip  
With Sealer  
Top Head Size: 16mm x 20mm  
Bottom Head Size: 14mm x 18mm  
Stem Length: 10mm  
Elantra & Sonata  
2002 - On

UNIT PACKAGE: 15



**21069**  
(92351-37000)  
Natural Nylon

Headlight Assembly Grommet  
Head Diameter: 15mm  
Stem Length: 8mm  
Fits Into 10mm Hole  
XG300/350  
2001 - On  
Kia  
2000 - On

UNIT PACKAGE: 25



**21065**  
(87756-35000)  
White Nylon

Rocker Moulding Nylon Nut  
M5.5 (#12) Screw Size  
Head Size: 13mm x 13mm  
Stem Length: 10mm  
Fits Into 9mm Hole  
Accent, Santa Fe,  
Sonata & Tiburon  
1995 - On

UNIT PACKAGE: 25



**21068**  
(86848-22000)  
Black Nylon

Fender Apron Nylon Nut  
M4.8 (#10) Screw Size  
Head Diameter: 16mm  
Stem Length: 11mm  
Fits Into 8.5mm Square Hole  
Accent, Elantra,  
Sonata & Tiburon  
1995 - On

UNIT PACKAGE: 25



**21066**  
(87758-37000)  
White Nylon

Fender & Rocker Moulding  
Nylon Nut With Sealer  
M4.2 (#8) Screw Size  
Head Size: 17mm x 17mm  
Stem Length: 14mm  
Hyundai Accent & Sonata  
1999 - On  
Kia  
2001 - On

UNIT PACKAGE: 25

HYUNDAI (Cont.)

INFINITI

INFINITI (Cont.)



**20543**  
(81126-37010)  
Black Nylon

Hood Insulation Retainer  
Head Diameter: 26mm  
Stem Diameter: 12mm  
Stem Length: 14mm  
Hyundai Elantra & Sonata  
And Kia Optima  
1995 - On

UNIT PACKAGE: 15



**20961**  
Not Available From O.E.M.  
White Nylon

Drip Moulding Clip  
With Sealer  
Top Width: 25mm  
Overall Height: 16mm  
Fits Into 5mm Hole  
Infiniti M45, I30 & G35  
2005 - On  
Nissan Altima, Maxima  
& 350Z  
2002 - On

UNIT PACKAGE: 15



**20673**  
(80874-0P000)  
White Nylon

Cowl Vent Grommet  
With Sealer  
Head Size: 13mm x 13mm  
Stem Length: 13mm  
Use With Auveco 17633  
Nissan & Infiniti  
1997 - On

UNIT PACKAGE: 15



**21070**  
(Hyundai: 82315-38000  
GM: 94530565)  
Yellow Nylon

Trim Panel Retainer;  
Top Head Diameter: 13mm  
Middle Head Diameter: 16mm  
Bottom Head Diameter: 16mm  
Stem Diameter: 9.5mm  
Stem Length: 10mm  
Chevrolet 2004 - On  
Hyundai Accent, Santa Fe, Sonata  
Tiburon & XG300/350 1999 - On  
and Kia 2001 - On

UNIT PACKAGE: 25



**20886**  
(76882-6P000)  
White Nylon

Moulding Clip  
Top Head Size: 8mm x 15mm  
Bottom Head Dia: 15mm  
Stem Length: 9mm  
Infiniti  
2005 - On

UNIT PACKAGE: 25



**20604**  
(01281-00711)  
Natural Nylon

Rocker Moulding  
Screw Grommet  
M4.2 (#8) Screw Size  
Head Diameter: 20mm  
Stem Length: 15mm  
Nissan & Infiniti  
1995 - On

UNIT PACKAGE: 10



**21111**  
(01281-00331)  
Natural Nylon

Bumper, Rocker Panel  
& Light Mounting  
Screw Grommet  
With Sealer  
M6.3 (#14) Screw Size  
Head Diameter: 20mm  
Stem Length: 16mm  
Fits Into 10mm Square Hole  
Infiniti  
1997 - On  
Nissan  
1996 - On

UNIT PACKAGE: 25



**21067**  
(86593-24000)  
Stainless Steel

Bumper & Grille Retainer  
Width: 13mm  
Length: 30mm  
Accent, Santa Fe & Sonata  
1995 - On

UNIT PACKAGE: 25



**20764**  
(01281-00831)  
Natural Nylon

Bumper, Fender & Light  
Screw Grommet  
M4.2 (#8) Screw Size  
Head Diameter: 16mm  
Stem Length: 10mm  
Fits Into 9mm x 9mm Hole  
Infiniti and Nissan 240SX,  
Altima, Frontier, Maxima, Pathfinder,  
Quest & Xterra  
1989 - On

UNIT PACKAGE: 25

## INFINITI (Cont.)



**20736**  
(01281-01081)  
Natural Nylon

Front Bumper Nylon Nut  
M4.8 (#10) Screw Size  
Flange Diameter: 16mm  
Overall Length: 22mm  
Infiniti & Nissan  
1997 - On

UNIT PACKAGE: 15



**19468**  
(65846-40F00)  
Black Nylon

Hood Insulation Retainer  
Head Diameter: 28mm  
Stem Diameter: 6mm  
Stem Length: 10mm  
J30, M30 & Q45  
1989-On

UNIT PACKAGE: 15



**20668**  
(01553-09791)  
White Nylon

Trim Panel Retainer  
Top Head Diameter: 13mm  
Middle Head Diameter: 16mm  
Bottom Head Diameter: 18mm  
Stem Diameter: 9mm  
Stem Length: 14mm  
Nissan & Infiniti  
1999 - On

UNIT PACKAGE: 15



**20669**  
(01553-07111)  
Black Nylon

Trim Panel Retainer  
Top Head Diameter: 13mm  
Middle Head Diameter: 15mm  
Bottom Head Diameter: 18mm  
Stem Diameter: 9mm  
Stem Length: 15mm  
Nissan Altima and Infiniti  
G35 & Q45  
1997 - On

UNIT PACKAGE: 25

## INFINITI (Cont.)



**20953**  
(11296-AG000)  
Black Nylon

Front Bumper And  
Radiator Support  
Push-Type Retainer  
Head Diameter: 20mm  
Stem Length: 13mm  
Fits Into 8mm Hole  
Infiniti FX 35/45 and  
Nissan Altima, Maxima  
& Quest  
2002 - On

UNIT PACKAGE: 25



**21017**  
(76882-0M000)  
White

Nylon "U" Nut  
M4.8 (#10) Screw Size  
Panel Range: Up To 1.5mm  
Center of Hole To Edge: 8mm  
Nissan & Infiniti  
1995 - On

UNIT PACKAGE: 15

## ISUZU



**17195**  
(Isuzu: 8942180270)  
Black Nylon

Grille Clip  
13mm Wide 22mm Long  
Ford Escort, Honda,  
Isuzu, Mitsubishi & Plymouth Laser

UNIT PACKAGE: 25



**17355**  
(GM: 94467458;  
Isuzu: 8944674584)  
Nylon

Windshield Reveal Moulding Clip  
Geo Storm  
1992-On

UNIT PACKAGE: 10

## ISUZU (Cont.)



**14739**  
(Isuzu: 8941340270;  
Toyota: 90189-05012)  
Natural Nylon

#6 Screw Size  
16mm Wide  
12mm Long  
Snaps Into 6mm x 10mm Hole

UNIT PACKAGE: 50



**14269**  
(Isuzu: 8942264920;  
Mazda: 9927-40-825;  
Toyota: 67771-01010,  
67771-12010)  
White Nylon

Door Panel Retainer  
Top Head Diameter: 13mm  
Middle Head Diameter: 15.5mm  
Bottom Head Diameter: 18mm  
Stem Length: 14mm  
Overall Length: 20.5mm  
Stem Diameter: 9.5mm

UNIT PACKAGE: 25



**14696**  
(Isuzu: 8942981190;  
Honda: 90684-SA5-0030;  
Nissan: 10998-30880)  
Black Nylon

Push-Type Retainer  
Head Diameter: 15mm  
Stem Length: 11mm  
Fits Into 6mm Hole

UNIT PACKAGE: 25

ISUZU (Cont.)

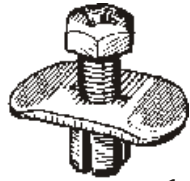

**14727**

(Isuzu: 8942211500;  
Nissan: 63844-00100)  
Black Nylon

Push-Type Retainer  
Head Size: 14mm x 22mm  
Stem Length: 9mm  
Fits Into 7mm Hole

UNIT PACKAGE: 25

KIA



**21069**

(92351-37000)  
Natural Nylon

Headlight Assembly Grommet  
Head Diameter: 15mm  
Stem Length: 8mm  
Fits Into 10mm Hole  
Hyundai  
2001 - On  
Kia Rio & Spectra  
2000 - On

UNIT PACKAGE: 25

KIA (Cont.)



**21070**

(Hyundai: 82315-38000)  
GM: 94530565)  
Yellow Nylon

Trim Panel Retainer  
Top Head Diameter: 13mm  
Middle Head Diameter: 16mm  
Bottom Head Diameter: 16mm  
Stem Diameter: 9.5mm  
Stem Length: 10mm  
Chevrolet 2004 - On  
Hyundai 1999 - On  
and Kia Optima, Rio &  
Sorento 2001 - On

UNIT PACKAGE: 25



**17076**

(GM: 94145515;  
Isuzu: 89414-55150)

Inner Fender Shield &  
Bumper Fascia Retainer  
Head Dia: 18mm  
Stem Length: 23mm  
Stem Dia: 7mm  
Geo Storm &  
Isuzu 1990-On

UNIT PACKAGE: 25



**21066**

(87758-37000)  
White Nylon

Fender & Rocker Moulding  
Nylon Nut With Sealer  
M4.2 (#8) Screw Size  
Head Size: 17mm x 17mm  
Stem Length: 14mm  
Hyundai 1999 - On  
Kia Optima & Sorrento  
2001 - On

UNIT PACKAGE: 25



**16858**

(Kia: MNA01-56-145;  
Mazda: NA01-56-145;  
Nissan: 63844-01A00;  
Ford: MNA01-56145,  
NA01-56145)  
Black Nylon

Inner Fender Push-Type Retainer  
Head Dia: 20mm (25/32")  
Stem Length: 18mm (23/32")  
Fits Into 8mm (5/16") Hole  
Kia, Ford, Mazda & Nissan

UNIT PACKAGE: 25

LEXUS



**20312**

(GM: 15021761;  
Chry: 5027550AB)  
Yellow Nylon

Hood Prop Rod Clip  
7mm Rod Diameter  
Snaps Into 10mm Hole  
GM Cars & Trucks  
Chrysler PT Cruiser  
Isuzu Hombre  
1990 - On

UNIT PACKAGE: 10



**20543**

(81126-37010)  
Black Nylon

Hood Insulation Retainer  
Head Diameter: 26mm  
Stem Diameter: 12mm  
Stem Length: 14mm  
Hyundai Elantra & Sonata  
And Kia Optima  
1995 - On

UNIT PACKAGE: 15



**19492**

(75039-33040)

Front Fender  
Moulding Clip  
ES300  
1991 - On

UNIT PACKAGE: 5

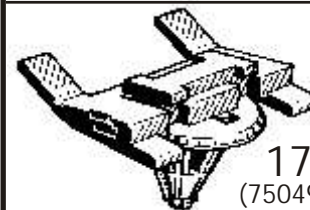

**17989**

(75049-33010)  
Black Nylon

Side Moulding Retainer  
Lexus 1990-On

UNIT PACKAGE: 5



# LEXUS CLIPS & FASTENERS

 <p><b>19899</b> (75397-48010) Red Nylon</p> <p>Moulding Clip ES300 &amp; RX300 1999 - On</p> <p>UNIT PACKAGE: 15</p>	 <p><b>20877</b> (75392-60030) Gray Nylon</p> <p>Rocker Panel Moulding Clip Head Diameter: 18mm Overall Length: 19mm Lexus 2000 - On</p> <p>UNIT PACKAGE: 15</p>	 <p><b>19482</b> (75039-33010) Brown &amp; White Nylon</p> <p>Front Door Outside Moulding Clip ES300 1991-On</p> <p>UNIT PACKAGE: 5</p>
 <p><b>20661</b> (75397-33010) White Nylon</p> <p>Body Side Moulding Clip With Sealer Head Size: 16mm x 20mm Stem Length: 9mm Lexus ES300 1997 - On</p> <p>UNIT PACKAGE: 10</p>	 <p><b>20875</b> (75394-60060) Yellow Nylon</p> <p>Fender Moulding Clip With Sealer Head Diameter: 18mm Stem Length: 20mm Lexus 2000 - On</p> <p>UNIT PACKAGE: 10</p>	 <p><b>20662</b> (90467-12070) Black Nylon</p> <p>Bumper Cover Clip Head Size: 13mm x 13mm Stem Length: 12mm Fits Into 9mm Square Hole Lexus GS300 &amp; GS400 1998 - On</p> <p>UNIT PACKAGE: 10</p>
 <p><b>20605</b> (75397-48030) Orange Nylon</p> <p>Moulding Clip With Sealer Head Size: 15mm x 20mm Stem Length: 15mm Lexus 1999 - On</p> <p>UNIT PACKAGE: 10</p>	 <p><b>20876</b> (75492-60030) Gray Nylon</p> <p>Fender Moulding Clip With Sealer Head Diameter: 18mm Stem Length: 20mm Lexus 2000 - On</p> <p>UNIT PACKAGE: 10</p>	 <p><b>19776</b> (75545-24030) White Nylon</p> <p>Windshield Moulding Clip SC300 &amp; SC400 1992 - On</p> <p>UNIT PACKAGE: 10</p>
 <p><b>19900</b> (75395-33030) Pink Nylon</p> <p>Moulding Clip ES300 &amp; RX300 1999 - On</p> <p>UNIT PACKAGE: 15</p>	 <p><b>19120</b> (75039-33060) Brown &amp; White Nylon</p> <p>Door Lower Moulding Clip ES300 1991-On</p> <p>UNIT PACKAGE: 10</p>	 <p><b>20738</b> (53271-44010) Black Nylon</p> <p>Headlight Bracket Clip 25mm Wide, 40.5mm Long Lexus IS-300 and Toyota Camry &amp; RAV 4 2001 - On</p> <p>UNIT PACKAGE: 4</p>



**19783**

(Ford: N811169-S,  
W705550-S300;  
Toyota: 90075-10801,  
90189-06111)  
White Nylon

Head Diameter: 13mm  
Stem Length: 9mm  
Fits Into 11mm Hole  
Ford, Lexus & Toyota

UNIT PACKAGE: 50



**21084**

(52599-0E010)  
Black Nylon

Rear Bumper Grommet  
With Sealer  
Head Diameter: 21mm  
Shoulder Diameter: 13mm  
Stem Length: 27mm  
RX 330, RX 350  
& RX 400h  
2004 - On

UNIT PACKAGE: 10



**19534**

(90467-10152)  
Natural Nylon

Cowl Vent Grommet  
Flange Diameter: 18mm  
Stem Length: 16mm  
Fits Into 9mm Hole  
Use With Auveco 19535  
Lexus ES300, Toyota Camry  
& Tercel  
1995 - On

UNIT PACKAGE: 10



**19742**

(90189-06104)  
Natural Nylon

Fender Lining  
Screw Grommet  
#12 (M5.5) Screw Size  
Head Diameter: 18mm  
Stem Length: 15mm  
Fits Into A 9mm Square Hole  
Lexus IS300 And Toyota  
Avalon, Camry & Sienna  
1997 - On

UNIT PACKAGE: 15



**19535**

(90467-07126)  
Black Nylon

Cowl Vent Pin Retainer  
Head Diameter: 16mm  
Stem Length: 17mm  
Use With Auveco 19534  
Lexus ES300, Toyota Camry  
& Tercel 1995 - On

UNIT PACKAGE: 10



**20660**

(90901-89004)  
Yellow Nylon

Bumper Screw Grommet  
With Sealer  
M6.3 (#14) Screw Size  
Head Size: 16.5mm x 18mm  
Stem Length: 25mm  
Lexus GS300 & GS400  
1998 - On

UNIT PACKAGE: 10



**20758**

(53879-58010)  
Black Nylon

Front Fender & Bumper  
Cover Clip  
Width: 25mm  
Length: 34mm  
Use With Auveco 20757  
Lexus and Toyota 4 Runner,  
Highlander, Sienna & Solara  
2000 - On

UNIT PACKAGE: 5



**14273**

(90189-06005)  
White Nylon

Screw Grommet  
#14 (1/4") or M6.3-1.81 Screw Size  
Head Diameter: 18mm  
Stem Length: 16mm  
Fits Into 8mm x 8mm Hole  
Lexus & Toyota

UNIT PACKAGE: 50



**21015**

(52535-50060,  
52535-0E010)  
Black Nylon

Front Bumper  
Screw Grommet  
M5.5 - M6 (#12) Screw Size  
Head Size: 17mm x 30mm  
Stem Length: 9mm  
Lexus IS250, IS350,  
RX330 & RX350 and  
Toyota Camry, Highlander  
& Tacoma  
2001 - On

UNIT PACKAGE: 5



**20757**

(47749-58010)  
Black Nylon

Front Fender & Bumper  
Cover Pin Retainer  
Head Diameter: 15mm  
Stem Length: 25mm  
Use With Auveco 20758  
Lexus and Toyota 4 Runner,  
Highlander, Sienna & Solara  
2000 - On

UNIT PACKAGE: 10



**14267**

(90189-06013)  
Black Nylon

Screw Grommet  
#14 (1/4") or M6.3-1.81 Screw Size  
Head Diameter: 20mm  
Stem Length: 17mm  
Fits Into 8mm x 8mm Hole  
Lexus & Toyota

UNIT PACKAGE: 25



**20878**  
(90467-A0008)  
Black Nylon

Bumper Cover Retainer  
Head Diameter: 19mm  
Stem Diameter: 7.5mm  
Stem Length: 16mm  
Lexus, Toyota & Scion  
1995 - On

UNIT PACKAGE: 50



**19113**  
(90467-08124)  
Black Nylon

Hood Insulation Retainer  
Head Diameter: 25mm  
Stem Diameter: 8mm  
Stem Length: 12mm  
Toyota Supra 1993-On  
Lexus 1994-89

UNIT PACKAGE: 15



**20473**  
(67771-12070)  
White Nylon

Door Panel &  
Rocker Moulding Retainer  
With Sealer  
Top Head Diameter: 13mm  
Bottom Head Diameter: 18mm  
Stem Diameter: 11mm  
Stem Length: 14mm  
Lexus SC300/400  
Toyota Avalon & Corolla  
1992 - On

UNIT PACKAGE: 15



**20874**  
(90467-07049-CO)  
Black Nylon

Trim Panel Retainer  
Head Diameter: 25mm  
Stem Diameter: 7mm  
Stem Length: 23mm  
Lexus  
2000 - On

UNIT PACKAGE: 25



**19729**  
(90467-09050)  
Black Nylon

Hood Insulation Retainer  
Head Diameter: 25mm  
Stem Length: 10mm  
Fits Into 7mm Hole  
Lexus, Toyota Camry & Solara  
1998-On

UNIT PACKAGE: 15



**20558**  
(62217-13010)  
White Nylon

Garnish Moulding Retainer  
Top Head Diameter: 13mm  
Middle Head Diameter: 16mm  
Bottom Head Diameter: 15mm  
Stem Diameter: 10mm  
Stem Length: 11mm  
Lexus and Toyota Corolla,  
Matrix & 4 Runner  
2003 - On

UNIT PACKAGE: 25



**18297**  
(Toyota: 90467-08004,  
90467-08011)  
(GM: 94842841, 94849113)  
Black Nylon

Hood Seal Retaining Clip  
Head Diameter: 13mm  
Stem Length: 11mm  
Fits Into 5mm Hole  
Lexus, Toyota, Geo Prizm & Nova  
1985 - On

UNIT PACKAGE: 50



**17991**  
(90467-06092)  
White Nylon

Retaining Clip  
Head Size: 8mm x 17mm  
Stem Length: 14mm  
Fits Into 8mm Hole  
Lexus 1990-On

UNIT PACKAGE: 10



**21012**  
(75867-AA010)  
Black Nylon

Rocker Panel &  
Scuff Plate Retainer  
Top Head Diameter: 13mm  
Bottom Head Diameter: 18mm  
Stem Diameter: 9.5mm  
Stem Length: 14mm  
Lexus ES300 & ES330  
2002 - On  
Toyota Avalon, Camry,  
Scion & Solara  
2004 - On

UNIT PACKAGE: 15



**20575**  
(67771-12080)  
Yellow & White Nylon

Door Panel & Rocker  
Moulding Retainer  
Top Head Diameter: 13mm  
Middle Head Diameter: 16mm  
Bottom Head Diameter: 18mm  
Stem Diameter: 10mm  
Stem Length: 13mm  
Overall Length: 20mm  
Toyota & Lexus  
1998 - On

UNIT PACKAGE: 15



**17990**  
(90467-09138)  
Black Nylon

Retaining Clip  
Head Size: 14mm x 15mm  
Stem Length: 19mm  
Fits Into 7mm Hole  
Lexus 1990-On

UNIT PACKAGE: 5



**20559**

(GM: 88970345;  
Toyota: 90467-10167)  
Blue Nylon

Garnish Moulding Retainer  
Top Head Diameter: 13mm  
Middle Head Diameter: 16mm  
Bottom Head Diameter: 18mm  
Stem Diameter: 9mm x 9mm  
Stem Length: 11mm  
Pontiac Vibe, Lexus and Toyota  
2000 - On

UNIT PACKAGE: 25



**17439**

(90467-09093)  
Black Nylon

Bumper Cover  
Push-Type Retainer  
Head Diameter: 15mm  
Stem Length: 27mm  
Fits Into 9mm Hole  
LS-400

UNIT PACKAGE: 10



**20955**

(90467-07201)  
Black Nylon

Engine Under Cover  
Push-Type Retainer  
Head Diameter: 20mm  
Stem Length: 10mm  
Fits Into 7mm Hole  
Lexus ES300/330 and  
Toyota Avalon, Camry & Solara  
2002 - On

UNIT PACKAGE: 10



**21102**

(90467-A0005)  
White Nylon

Door Trim Panel Retainer  
With Sealer  
Top Head Diameter: 13mm  
Middle Head Diameter: 16mm  
Bottom Head Diameter: 18mm  
Stem Diameter: 8.5mm  
Stem Length: 14mm  
Lexus ES 350, GX 470, IS 250, IS  
350, IS F, LS 460 & LS 600HL and  
Toyota Camry, FJ Cruiser,  
Highlander, RAV4 & 4-Runner  
2001 - On

UNIT PACKAGE: 15



**18939**

(90467-09101)  
Black Nylon

Bumper Cover  
Push-Type Retainer  
Head Diameter: 18mm  
Stem Length: 23mm  
Fits Into 9mm Hole  
ES300  
1993-On

UNIT PACKAGE: 25



**17992**

(90467-07138)  
Black Nylon

Push-Type Retainer  
Head Diameter: 20mm  
Stem Length: 12mm  
Fits Into 7mm Hole  
Lexus 1990-On

UNIT PACKAGE: 10



**17988**

(90467-09143)  
Black Nylon

Push-Type Retainer  
Head Diameter: 19mm  
Stem Length: 26mm  
Fits Into 9mm Hole  
Lexus 1990-On

UNIT PACKAGE: 10



**19219**

(90467-09096)  
Black Nylon

Front Bumper  
Push-Type Retainer  
Head Diameter: 15mm  
Stem Length: 27mm  
Fits Into 9mm Hole  
LS400 1993-On  
Toyota Celica & Supra  
1989-On

UNIT PACKAGE: 10



**19257**

(67771-12050)  
Maroon Nylon

Front & Rear Door  
Trim Board Retainer  
Small Head Diameter: 13mm  
Large Head Diameter: 18mm  
Stem Diameter: 9mm  
Stem Length: 14mm  
Lexus and Toyota Celica,  
Corolla & Previa 1990-On

UNIT PACKAGE: 15



**20577**

(GM: 88970494;  
Toyota:  
90467-07168)  
Black Nylon

Rocker Panel & Garnish Moulding  
Push-Type Retainer  
Head Diameter: 20mm  
Stem Length: 8mm  
Fits Into 7mm Hole  
Pontiac Vibe 2004 - 2003  
Lexus & Toyota  
2000 - On

UNIT PACKAGE: 15



**18270**

(90467-07117)  
Black Nylon

Push-Type Retainer  
Head Dia: 17mm  
Stem Length: 9mm  
Fits Into 7mm Hole  
Lexus 1990-On

UNIT PACKAGE: 10



**20869**

(GM: 88970767;  
Toyota: 90467-10183)  
Black Nylon

Front Fender Liner  
Push-Type Retainer  
Head Diameter: 18mm  
Stem Length: 7.5mm  
Fits Into 7mm Hole  
Lexus, Pontiac Vibe, and Toyota  
Celica, Corolla,  
Matrix & Solara  
1999 - On

UNIT PACKAGE: 10



**20534**

(69293-12050)  
Natural Nylon

Door Lock Rod Clip  
Rod Size: 5mm  
Fits Into 8.5mm Hole  
Right (Passenger) Side  
Lexus ES250, 300 & RX300  
And Toyota Tacoma  
1990 - On

UNIT PACKAGE: 10



**17993**

(90179-05060)  
Black Nylon

Nylon "U" Nut  
#10 Screw Size  
18mm Wide, 27mm Long  
Panel Range: Up To 3mm  
Center Of Hole To Edge: 14mm  
Lexus 1990-On

UNIT PACKAGE: 10



**20469**

(69293-12030)  
Natural Nylon

Door Lock Rod Clip  
Rod Size: 5mm  
Right (Passenger) Side  
Lexus ES 300 2001 - 97  
Toyota Camry, Celica, Corolla,  
Echo, Highlander, MR2, RAV4,  
Tundra and 4-Runner  
1994 - On

UNIT PACKAGE: 10



**20535**

(69293-12060)  
Yellow Nylon

Door Lock Rod Clip  
Rod Size: 5mm  
Fits Into 8.5mm Hole  
Left (Driver) Side  
Lexus ES250, 300 & RX300  
And Toyota Tacoma  
1990 - On

UNIT PACKAGE: 10



**20956**

(90467-05114)  
Black Nylon

Bumper & Fender Apron  
Nylon "U" Nut  
Screw Size: M5.5 (#12)  
Width: 20mm, Length: 36mm  
Center Of Hole To Edge: 14mm  
Panel Range: Up To 1mm  
Lexus & Toyota  
2000 - On

UNIT PACKAGE: 10



**20470**

(69293-12040)  
Yellow Nylon

Door Lock Rod Clip  
Rod Size: 5mm  
Left (Driver) Side  
Lexus ES 300 2001 - 97  
Toyota Camry, Celica, Corolla,  
Echo, Highlander, MR2, RAV4,  
Tundra and 4-Runner  
1994 - On

UNIT PACKAGE: 10



**20380**

Not Supplied By O.E.M.  
Black Nylon

Cable Strap  
Length: 200mm (8")  
Max. Bundle Dia: 44mm (1-3/4")  
Fits Into 6.3mm (1/4") Hole  
Import Cars

UNIT PACKAGE: 25

For The Most  
Up-To-Date  
Information  
On New Items  
Available  
From Auveco,  
refer to the  
"Hot New Items"  
Section of the  
Auveco Web Site  
([www.auveco.com](http://www.auveco.com))

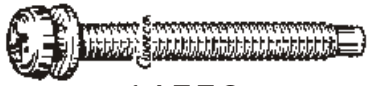

**16550**

(GJ21-51-047A)

M5-.8 x 42mm  
Headlight Adjusting Screw

UNIT PACKAGE: 25



**16555**

(GJ21-51-036)

Headlight Adjusting Spring

UNIT PACKAGE: 10



**19469**

(G219-51-081)

White Nylon

Front Combination  
Headlight  
Pivot Holder  
MX-6, MPV &  
Protege  
1995-On

UNIT PACKAGE: 10



**19228**

(NA01-50-101A)

Nylon

Bumper Clip  
Miata  
1992-On

UNIT PACKAGE: 10



**18822**

(KA80-51-RF5A)

Nylon

Body Side Garnish Moulding Clip  
Mazda Millenia & Ford Probe  
1995-On

UNIT PACKAGE: 15



**18882**

(Ford: KA80-51-PR6;  
Mazda: EA01-50-048)

Black Nylon

Body Side Lower  
Wide Moulding Grommet  
Ford Probe & Mazda MX6  
1993-On

UNIT PACKAGE: 10



**19450**

(T001-50-M48B)

Natural Nylon

Rear Door Garnish Clip  
Millenia  
1995 - On

UNIT PACKAGE: 25



**19451**

(B173-50-852A)

Black Nylon

Cowl Panel Clip  
Millenia  
1995 - On

UNIT PACKAGE: 15

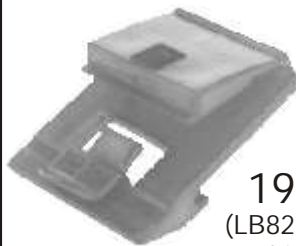

**19755**

(LB82-50-669A)

White Nylon

Door Belt  
Moulding Clip  
Width: 25mm  
Length: 32mm  
MPV  
1998 - On

UNIT PACKAGE: 10

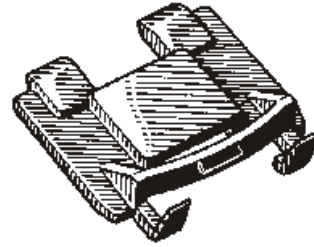

**12589**

(8173-50-931)

Nylon

Windshield Moulding Clip  
28mm Wide; 26mm Long

UNIT PACKAGE: 15

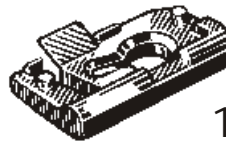

**15469**

Nylon

Windshield Reveal Moulding Clip  
15mm Wide, 25.5mm Long  
Nissan & Mazda

UNIT PACKAGE: 25



**14719**

(H001-50-609)

Nylon

Windshield Moulding Clip  
25mm Wide  
10mm Long

UNIT PACKAGE: 25



**17290**

(B092-50-609)

Nylon

Rear Window Moulding Clip  
MX6 1988-On  
Ford Probe 1988-On  
Mercury Tracer 1987-On

UNIT PACKAGE: 15

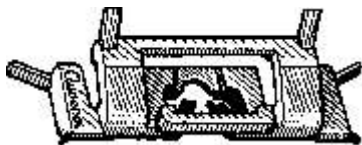

**14717**  
(HA01-50-609)  
Nylon

Windshield Moulding Clip  
45mm Wide  
13mm Long

UNIT PACKAGE: 25



**12591**  
(1243-50-609)  
Nylon

Windshield Moulding Clip  
28.5mm Wide  
Clip Length: 14.5mm  
Arm Length: 22.5mm

UNIT PACKAGE: 25



**19648**  
(HG30-50-6B9A)  
Brown Nylon

Windshield Clip  
Width: 13mm  
Length: 49mm  
Height: 11mm  
929 & Millenia  
1992 - On

UNIT PACKAGE: 10



**19452**  
(JOY1-50-619C)  
White Nylon

Rear Window  
Moulding Clip  
With Adhesive Backing  
Millenia  
1995 - On

UNIT PACKAGE: 10



**20958**  
(GJ6A-68-162)  
White Nylon

Windshield Garnish  
Moulding Retainer  
Top Head Size:  
10mm x 13mm  
Bottom Head  
Diameter: 16mm  
Stem Length: 33mm  
Fits Into 10mm Hole  
3,5 & RX8  
2004 - On

UNIT PACKAGE: 10



**20960**  
(GM9E-63-938A)  
White Nylon

Windshield Moulding Clip  
Head Size:  
17mm x 20mm  
Stem Length: 21mm  
Fits Into 8mm Hole  
Mazda 6  
2003 - On

UNIT PACKAGE: 10



**20957**  
(G6JA-50-0Z5)  
Natural Nylon

Front Bumper  
Screw Grommet  
Screw Size: M4.2 (#8)  
Head Size:  
23mm x 24mm  
Stem Length: 14mm  
Miata, MPV, RX8  
3, 5 & 6  
2000 - On

UNIT PACKAGE: 15



**20984**  
(BC1M-50-0Z5)  
Natural Nylon

Front Bumper  
Screw Grommet  
M4.2 (#8) Screw Size  
Head Size:  
24mm x 28mm  
Stem Length: 14mm  
323, 626, Miata  
MPV & Protégé  
1995 - On

UNIT PACKAGE: 10



**19831**  
(LA01-50-6A8A)  
White Nylon

Window Screw Grommet  
With Sealer Gasket  
#6 Screw Size  
MPV  
1998 - On

UNIT PACKAGE: 10



**13930**  
(Nissan: 96706-B0700;  
Mazda: 9991-00-412)  
Natural Nylon

#8 Screw Size  
9.5mm Wide  
9.5mm Long

Snaps Into 7mm x 7mm Hole

UNIT PACKAGE: 50



**14255**  
(Mitsubishi: MS-480001;  
Honda: 75522-611-0000;  
Mazda: 9991-00-412)  
Black Nylon

#8 Screw Size  
9.5mm Wide  
9.5mm Long

Snaps Into 7mm x 7mm Hole

UNIT PACKAGE: 50



**14274**

(Mazda: 9991-00-601;  
Honda: 75521-611-0000;  
Nissan: 96706-P0105;  
Toyota: 90189-06010)  
Natural Nylon

#10 Screw Size  
13mm Wide; 13mm Long  
Snaps Into 8.5mm x 8.5mm Hole

UNIT PACKAGE: 25



**14357**

(9991-00-501)  
Natural Nylon

#10 Screw Size  
12mm Wide  
12mm Long  
Snaps Into 8mm x 8mm Hole

UNIT PACKAGE: 25



**14313**

(Mazda: 9991-00-503)  
Honda: 90662-671-0030;  
Nissan: 68425-H5000)  
Natural Nylon

#10 Screw Size  
17mm Wide  
17mm Long  
Snaps Into 8mm x 8.5mm Hole

UNIT PACKAGE: 25



**14364**

(9991-00-403)  
Natural Nylon

#8 Screw Size  
Head Diameter: 13mm  
Fits Into 7mm x 7mm Hole

UNIT PACKAGE: 25



**14362**

(8545-50-786)  
Black Nylon

#10 Screw Size  
Head Diameter: 13mm  
Fits Into 7mm Hole

UNIT PACKAGE: 25



**14366**

(9991-00-402)  
Natural Nylon

Screw Grommet  
#6 Screw Size  
9.5mm Wide, 9.5mm Long  
Stem Length: 16mm  
Fits Into 7mm x 7mm Hole  
Also for Nissan/Datsun

UNIT PACKAGE: 50



**14695**

(Mazda: H001-50-841;  
Honda: 90661-SC7-0030;  
Mitsubishi: MS-480012;  
Nissan: 01651-00481,  
74798-S9000;  
Toyota: 90189-06042)  
White Nylon

Screw Grommet  
#8 Screw Size  
Head Diameter: 16mm  
Stem Length: 17mm  
Fits Into 8mm x 8mm Hole

UNIT PACKAGE: 25



**19832**

(LB84-68-AD5)  
White Nylon

Door Trim  
Screw Grommet  
With Sealer Gasket  
#6 Screw Size  
Head Size: 10mm x 10mm  
Stem Length: 15mm  
MPV

1998 - On

UNIT PACKAGE: 10



**20579**

(FD02-50-798)  
Black Nylon

Cowl Vent Grommet  
With Sealer  
M4.2 (#8) Screw Size  
Head Size: 12mm x 22mm  
Stem Length: 13mm  
323, 626, Millenia & MX6  
1995 - On

UNIT PACKAGE: 10



**19833**

(H260-50-6K8)  
White Nylon

Cowl Screw Grommet  
With Sealer Gasket  
#8 (M4.2 - 1.41) Screw Size  
Head Size: 16mm x 22mm  
Stem Length: 20mm  
MPV

1998 - On

UNIT PACKAGE: 10



**19743**

(GJ21-58-502A)  
Natural Nylon

Window Moulding  
Screw grommet  
#12 (M5.5) Screw Size  
18mm Wide, 22mm Long  
Snaps Into 11mm Hole

626

1998-On

UNIT PACKAGE: 15



**20463**

(S084-58-502)  
Natural Nylon

Door Glass  
Screw Grommet  
#12 Screw Size  
18mm Wide, 32mm Long  
Stem Length: 10mm

626

2000 - ON

UNIT PACKAGE: 10

When The World Thinks Of  
Body Hardware &  
Specialty Fasteners,  
Only One Name Comes To  
Mind... Auveco





**19753**  
(GA2A-56-399A)  
Black Nylon

Front Fender  
Plate Seal Clip  
Head Diameter: 18mm  
Stem Length: 26mm  
626  
1998 - On

UNIT PACKAGE: 10



**17451**  
(H001-68-719B)  
Natural Nylon

Rocker Scuff Plate Retainer  
Ford Probe 1988-On  
Mazda MX6 1988-On

UNIT PACKAGE: 25



**19138**  
(Ford: F1CZ-5802316A;  
Mazda: BW0A-50-792)  
Gray Nylon

Cowl Top Vent Grille Retainer  
Ford Escort & Tracer  
Mazda 1991 - On

UNIT PACKAGE: 15



**17551**  
(GJ21-50-H81)  
Natural Nylon

Cowl Screen Grommet  
Ford Probe 1988-On  
Mazda 626 & MX6 1988-On

UNIT PACKAGE: 25



**17552**  
(GJ21-50-H82)  
Natural Nylon

Cowl Screen Grommet  
Ford Probe 1988-On  
Mazda 626 & MX6 1988-On

UNIT PACKAGE: 25



**17553**  
(KA01-50-H16)  
Green Nylon

Rear Hatch Grommet  
Ford Probe 1988-On  
Mazda MX 6 1988-On  
Use With 17554

UNIT PACKAGE: 25



**17554**  
(KA01-50-H15A)  
Black Nylon

Rear Hatch Retainer  
Ford Probe 1988-On  
Mazda MX6 1988-On  
Use With 17553

UNIT PACKAGE: 25



**14367**  
(9924-90-512B)  
Black Nylon

Retainer  
Head Diameter: 12mm  
Stem Length: 12mm  
Snaps Into 4mm Hole  
Panel Thickness: 2mm

UNIT PACKAGE: 50



**18458**  
(Ford: F1CZ-16774-A;  
Mazda: B455-56-741)  
Black Nylon

Hood Insulation Retaining Clip  
Head Diameter: 14mm  
Stem Length: 10mm  
Fits Into 6mm Hole  
Ford Probe & MX6 1992-88

UNIT PACKAGE: 25



**14349**  
(Mazda: 9926-40-543A;  
Nissan: 01553-00291)  
Black Nylon

Retaining Clip  
Head Dia: 11mm  
Stem Length: 15mm  
Fits Into 5.5mm Hole  
Panel Thickness: 5mm

UNIT PACKAGE: 50



**18271**  
(9926-40-531B)  
Black Nylon

Hood Insulation Retainer  
Head Diameter: 14mm  
Stem Diameter: 6mm  
Stem Length: 15mm

UNIT PACKAGE: 25



**16777**  
(Mazda: B001-68-302-00;  
Toyota: 90950-01248)  
Black Nylon

Retaining Clip  
Head Dia: 15mm  
Stem Length: 15mm  
Panel Thickness: 2mm  
Fits Into 8mm Hole

UNIT PACKAGE: 25



**14380**  
(8133-50-022)  
Black Nylon

Retaining Clip  
Head Diameter: 18mm  
Stem Length: 18mm  
Snaps Into 8mm Hole  
Panel Thickness: 7mm

UNIT PACKAGE: 25



**14709**

(Mazda: G030-68-885-B-38;  
Ford: F22Z-16774-A,  
GA2A-56694)  
Black Nylon

Hood Insulation Retainer  
Head Diameter: 20mm  
Stem Length: 9mm  
Fits Into 6mm Hole  
UNIT PACKAGE: 25



**17453**

(B003-68-865-96)  
Gray Nylon

Rear Compartment  
Interior Trim Retainer  
Head Diameter: 15mm  
Stem Length: 14mm  
Stem Diameter: 6.5mm  
Ford Probe 1988-On  
Mazda MX6 1988-On  
UNIT PACKAGE: 50

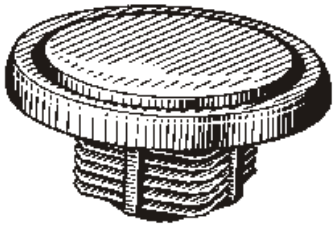

**14708**

(B100-68-695)  
Gray Nylon

Panel Fastener  
Head Diameter: 40mm  
Stem Length: 17mm  
Fits Into 20mm x 20mm Hole  
UNIT PACKAGE: 15



**18692**

(Mazda: G031-58-762;  
Toyota: 67867-89103,  
97868-89101)  
Natural Nylon

Weatherstrip Retainer  
Head Size: 5mm x 15mm  
Stem Length: 10mm  
Fits Into 5mm Hole  
4-Runner 1989-83  
Mazda 1996-On  
UNIT PACKAGE: 50



**20460**

(G043-50-742)  
Black Nylon

Cowl Panel Retainer  
With Sealer  
Top Head Dia.: 14mm  
Bottom Head Dia.: 18mm  
Stem Dia.: 9mm  
Stem Length: 13mm  
626  
2000 - On

UNIT PACKAGE: 10



**14269**

(Mazda: 9927-40-825;  
Isuzu: 8942264920;  
Toyota: 67771-01010,  
67771-12010)  
White Nylon

Door Panel Retainer  
Top Head Diameter: 13mm  
Middle Head Dia.: 15.5mm  
Bottom Head Diameter: 18mm  
Stem Diameter: 9.5mm  
Stem Length: 14mm  
Overall Length: 20.5mm  
UNIT PACKAGE: 25



**20932**

(G18K-51-SJ3)  
White Nylon

Door Trim Panel Retainer  
With Sealer  
Top Head Diameter: 14mm  
Bottom Head Diameter: 18mm  
Stem Diameter: 12mm  
Stem Length: 14mm  
3, 5, 6, CX-7  
Miata & Protégé  
2001 - On

UNIT PACKAGE: 10



**18824**

(G350-68-AB1)  
White Nylon

Trim Panel Retainer  
Top Head Diameter: 13mm  
Bottom Head Diameter: 15mm  
Stem Length: 9.5mm  
Fits Into 9mm Hole  
Mazda 626, MX6, Millenia, MX3,  
929, Protege & MPV  
Ford Probe  
1992-On

UNIT PACKAGE: 50



**20983**

(GJ6R-68-ABX)  
White Nylon

Trim Panel Retainer  
With Sealer  
Top Head Diameter: 13mm  
Middle Head Diameter: 16mm  
Bottom Head Diameter: 18mm  
Stem Diameter: 9mm  
Stem Length: 13mm  
3, 5, 6, Miata & RX-8  
2003 - On

UNIT PACKAGE: 15



**20459**

(GA2A-68-AB1A)  
Black Nylon

Trim Panel Retainer  
Top Head Dia.: 15mm  
Bottom Head Dia.: 16mm  
Stem Dia.: 9mm  
Stem Length: 10mm  
626  
2000 - On

UNIT PACKAGE: 10



**14363**  
(9927-40-821)  
Nylon

Door Panel Retainer

Bottom Head Diameter: 17mm  
Stem Length: 14mm  
Overall Length: 20mm  
Fits Into 8mm Hole

UNIT PACKAGE: 25



**16778**  
(Mazda: 9927-40-822;  
Toyota: 62581-14020)  
Natural Nylon

Trim Panel Retainer  
Small Head Dia: 14mm  
Large Head Dia: 18mm  
Stem Length: 14mm  
Fits Into 8mm Hole

UNIT PACKAGE: 25



**19481**  
(GA2A-58-762)  
Blue Nylon

Weatherstrip Retainer  
Head Size: 5mm x 15mm  
Stem Length: 8mm  
Fits Into 6mm Hole  
Front & Rear Door  
and Hood Weatherstrip  
626 & Millenia  
1995 - On

UNIT PACKAGE: 50



**14697**  
(Mazda: N304-13-356-A;  
GM: 94198687;  
Honda: 90657-SA6-0030)  
Black Nylon

Push-Type Retainer  
Head Diameter: 14mm  
Stem Length: 11mm  
Fits Into 7mm Hole

UNIT PACKAGE: 25



**17478**  
(B101-68-252-00)  
Black Nylon

Interior Trim  
Push-Type Retainer  
Head Diameter: 14mm  
Stem Length: 16mm  
Fits Into 6mm Hole  
Ford Probe 1988-On  
Mazda MX6 1988-On

UNIT PACKAGE: 25



**20923**  
(Ford: 3M8Z-1502316-A;  
Mazda: GJ6E-50-715A)  
Black Nylon

Cowl Vent  
Push-Type Retainer  
Head Size: 8.5mm x 12mm  
Stem Length: 9mm  
Fits Into 5mm Hole  
Ford Fusion, Milan & Zephyr  
2006 - On  
Mazda 5 & 6  
2003 - On

UNIT PACKAGE: 15



**14260**  
(Mazda: 9926-50-625;  
Toyota: 90467-06017)  
Black Nylon

Push-Type Retainer  
Head Diameter: 15mm  
Stem Length: 12mm  
Fits Into 7mm Hole

UNIT PACKAGE: 15



**19306**  
(GA5R-56-392)  
Black Nylon

Shroud Seal Board  
Push-Type Retainer  
Head Diameter: 16mm  
Stem Length: 12mm  
Fits Into 6mm Hole

626  
1994-On

UNIT PACKAGE: 10



**20465**  
(UB39-45-919)  
Black Nylon

Front & Rear Fender  
Push-Type Retainer  
Head Diameter: 18mm  
Stem Length: 9mm  
Fits Into 8mm Hole

626  
2000 - On

UNIT PACKAGE: 10



**19747**  
(UB39-50-795)  
Black Nylon

Stone Guard  
Push-Type Retainer  
Head Diameter: 18mm  
Stem Length: 10mm  
Fits Into 8mm Hole  
MPV  
1998-On

UNIT PACKAGE: 10



**17632**  
(Mazda: B092-51-833;  
Ford: MB-455-56143)  
Black Nylon

Push-Type Retainer  
Head Diameter: 18mm  
Stem Length: 12mm  
Fits Into 8mm Hole  
Mazda & Ford Aspire

UNIT PACKAGE: 10



**18206**  
(GJ21-68885-B69)  
Gray Nylon

Push-Type Retainer  
Head Diameter: 18mm  
Stem Length: 12mm  
Fits Into 6mm Hole  
Ford Probe &  
MX6 1989-On

UNIT PACKAGE: 25



**21110**  
(B100-68-8550)  
Black Nylon

Rear Light Access Door  
Push-Type Retainer  
Head Diameter: 18mm  
Stem Length: 12mm  
Fits Into 8.5mm Hole  
323  
1986 - On

UNIT PACKAGE: 15



**19416**  
(Toyota: 90467-09139)  
Black Nylon

Bumper Cover &  
Wheel Housing  
Push-Type Retainer  
Head Diameter: 18mm  
Stem Length: 15mm  
Fits Into 9mm Hole  
Honda, Mazda 626 &  
Toyota Corolla  
1992-On

UNIT PACKAGE: 15



**20755**  
(GD7A-50-EA1)  
Black Nylon

Bumper Cover & Grille  
Push-Type Retainer  
Head Diameter: 19.5mm  
Stem Length: 15mm  
Fits Into 10mm Hole  
Mazda  
1999 - On

UNIT PACKAGE: 10



**14369**  
(1395-68-676,  
9926-50-635)  
Black Nylon

Push-Type Retainer  
Head Diameter: 20mm  
Stem Length: 9mm  
Fits Into 6mm Hole

UNIT PACKAGE: 15



**16000**  
(Honda:  
90675-SB3-003;  
Mazda: FB01-56-964;  
Nissan:  
63876-95596)  
Black Nylon

Push-Type Retainer  
Head Dia: 20mm  
Stem Length: 9mm  
Fits Into 8mm Hole

UNIT PACKAGE: 25



**19315**  
(BC1D-56-145)  
Black Nylon

Mud Guard Push-Type Retainer  
Head Diameter: 20mm  
Stem Length: (Exc. Pin): 9mm  
Fits Into 8mm Hole  
Protege  
1996-On

UNIT PACKAGE: 15



**16858**  
(Mazda: NA01-56-145;  
Kia: MNA01-56-145;  
Nissan: 63844-01A00;  
Ford: MNA01-56145,  
NA01-56145)  
Black Nylon

Inner Fender Push-Type Retainer  
Head Dia: 20mm (25/32")  
Stem Length: 18mm (23/32")  
Fits Into 8mm (5/16") Hole  
Mazda, Kia, Ford & Nissan

UNIT PACKAGE: 25

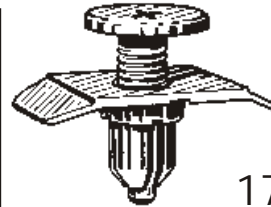

**17450**  
(Ford: E8B2-17C756C;  
Mazda: BF67-50-235)  
Black Nylon

Bumper Cover Retainer  
Head Size: 20mm x 30mm  
Stem Length: 11mm  
Fits Into 10mm Hole  
Ford Festiva 1988-On  
Mazda 323 1986-On

UNIT PACKAGE: 10

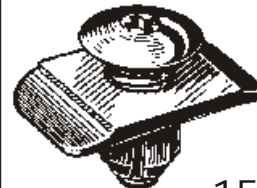

**15366**  
(Ford: E7GZ-17A904-B;  
Mazda: BF67-50-033)  
Gray Nylon

Bumper Retainer  
Head Size: 20mm x 30mm  
Stem Length: 11mm  
Fits Into 10mm Hole  
Mazda  
Mercury Tracer 1987-On

UNIT PACKAGE: 10



**16843**  
(Mazda:  
BF82-50-233;  
Nissan:  
01553-01393)  
Black Nylon

Bumper Cover Retainer  
Head Size: 20mm x 30mm  
Stem Length: 18mm  
Fits Into 10mm Hole

UNIT PACKAGE: 10

# MAZDA CLIPS & FASTENERS

Sec. 22



**17060**

(Ford: E92Z-17C756C;  
Mazda: GJ21-50-034)  
Black Nylon

Bumper Cover Retainer  
Head Size: 20mm x 30mm  
Stem Length: 20mm  
Fits Into 10mm Hole

Ford Probe & Mazda MX6 1989-On

UNIT PACKAGE: 10



**14365**

(9927-80-404)  
Nylon

Rod End Clip  
Holds 4mm Rods  
Snaps Into 6mm  
Hole

UNIT PACKAGE: 25

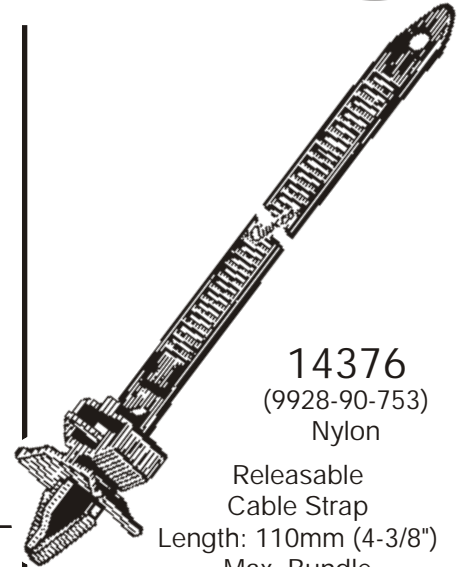

**14376**

(9928-90-753)  
Nylon

Releasable  
Cable Strap  
Length: 110mm (4-3/8")  
Max. Bundle  
Diameter: 25mm  
Fits Into 7mm Hole

UNIT PACKAGE: 15



**14378**

(9927-70-901)  
Nylon

Tube/Cable  
Routing Clip  
For Holding Multiple  
Cables or Tubes  
Diameter: 8mm  
Fits Into 6mm Hole

UNIT PACKAGE: 25



**20153**

White Door Lock Pawl  
Right-Hand Side  
Mazda Truck, Ford  
Continental, Contour,  
Explorer, Mountaineer, Mystique,  
Ranger, Sable & Taurus  
1996 - On

UNIT PACKAGE: 1



Not Actual Size

**14298**

(Mazda: 9928-91-053;  
Honda: 90672-SA0-0030)  
Nylon

Releasable Cable Strap  
Overall Length: 148mm (5-3/4")  
Max. Bundle  
Diameter: 30mm  
Fits Into 7mm Hole

UNIT PACKAGE: 25



**14714**

(GA976-1391)  
Nylon

Tube Clip  
For 12mm Tubes  
41mm Long

UNIT PACKAGE: 20



**20195**

Pink Door Lock Pawl  
Left-Hand Side  
Ford Continental, Contour,  
Explorer, Mountaineer, Mystique,  
Ranger, Sable  
& Taurus And Mazda Truck  
1996 - On

UNIT PACKAGE: 1



Not Actual Size

**20380**

Not Supplied By  
O.E.M.  
Black Nylon

Cable Strap  
Length: 200mm (8")  
5mm (3/16") Wide  
Max. Bundle Dia: 44mm (1-3/4")  
Fits Into 6.3mm (1/4") Hole  
Import Cars

UNIT PACKAGE: 25



**14359**

(9927-80-405)  
Nylon

Rod End Clip  
Holds 4mm Rods  
Snaps Into 6mm Hole

UNIT PACKAGE: 25

# Sec. 22 MERCEDES-BENZ CLIPS & FASTENERS

## MAZDA Cont.



**19754**  
(UB42-67-013)  
Black Nylon

Wiring Harness  
Routing Clip  
MPV  
1998 - On

UNIT PACKAGE: 15

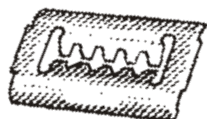

**17003**

(Mazda: GJ21-50-049;  
Ford: F32Z-17C756-S)

Bumper Cover Retainer  
Front & Rear Bumpers  
Mazda & Ford 1988 - On

UNIT PACKAGE: 50



**14750**

(Toyota: 53879-14010-A,  
53879-14020,  
53879-22030;  
GM: 94841226;  
Mazda: LA01-56-135)  
Black Nylon

Nylon "U" Nut  
Fender/Wheel  
Housing Applications  
#10 Screw Size

20mm Wide  
31mm Long  
Panel Range: Up to 1mm  
Center of Hole To Edge: 11mm  
Toyota, Geo Prizm & Nova and  
Mazda

UNIT PACKAGE: 15

**19669**

Same As 14750 Except For Packing

UNIT PACKAGE: 25

## MERCEDES-BENZ



**13142**

(000-990-21-92)  
Nylon

Moulding Clip

UNIT PACKAGE: 25



**20239**

(001-988-31-81)  
White Nylon

Body Side  
Moulding Clip  
Body Style 124  
1995 - 86

UNIT PACKAGE: 15



**13153**

(000-988-56-71)  
Nylon

Moulding Clip

UNIT PACKAGE: 25



**17668**

(123-990-01-92)  
Nylon

Moulding Clip  
Head Dia: 9mm x 11mm  
Stem Length: 10mm  
Fits Into 6mm x 6mm hole  
Mercedes-Benz  
1977-On

UNIT PACKAGE: 10



**20201**  
(006-988-30-78)  
Natural Nylon

Body Side  
Moulding Clip  
Body Style 124  
1995 - 86

UNIT PACKAGE: 10



**20657**

(004-988-76-78,  
004-988-77-78)  
Black Nylon

Moulding Clip  
11mm Wide  
20mm Long

UNIT PACKAGE: 15



**20658**

(201-988-06-78)  
Black Nylon

Moulding Clip  
16mm Wide  
22mm Long  
Fits Into 6mm Hole

UNIT PACKAGE: 10



**20197**

(201-988-07-78)  
Black Nylon

Body Side  
Moulding Clip  
Body Style 201  
1993 - 84

UNIT PACKAGE: 10

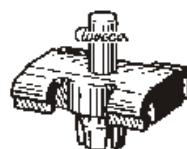

**16123**

(201-988-03-78)  
Nylon

Moulding Clip  
16.5mm Wide, 18mm Long  
Fits Into 6mm Hole

UNIT PACKAGE: 25



**20235**  
(002-994-65-45)  
White Nylon

Body Side Moulding Clip  
Body Styles  
124 & 201  
1995 - 84

UNIT PACKAGE: 10



**20202**  
(201-988-04-78)  
Natural Nylon

Body Side Quarter Panel  
Moulding Clip  
Body Style 201  
1995 - 84

UNIT PACKAGE: 10



**20198**  
(001-988-51-81)  
White Nylon

Body Side Moulding Clip  
Body Styles  
124 & 201  
1995 - 86

UNIT PACKAGE: 15



**20897**  
(002-988-51-81)  
Black Nylon

Grille Moulding Clip  
Fits Into 7mm Hole  
CLK320,  
CLK500 & ML350  
2003 - On

UNIT PACKAGE: 10



**20199**  
(006-988-35-78)  
White Nylon

Body Side Moulding Clip  
Body Style 201  
1993 - 87

UNIT PACKAGE: 10



**20236**  
(006-988-72-78)  
White Nylon

Body Side Moulding Clip  
Body Styles  
124 & 129  
1995 - 90

UNIT PACKAGE: 10



**20773**  
(211-988-00-81)  
Black Nylon

Cowl Cover Retainer  
Head Size: 20mm x 43mm  
Stem Length: 25mm  
Fits Into 8mm Hole  
E, CL & S Class  
2000 - On

UNIT PACKAGE: 10



**20656**  
(140-698-00-82)  
White Nylon

Rocker Moulding Clip  
Head Diameter: 12mm x 16mm  
Stem Length: 28mm  
Overall Length: 36mm

UNIT PACKAGE: 10



**20204**  
(001-988-29-81)  
Natural Nylon

Moulding Insert  
Head Diameter: 18mm  
Stem length: 13mm  
Fits Into 9mm Hole  
Body Styles  
124, 129 & 140  
1986 - On

UNIT PACKAGE: 15



**20205**  
(001-988-76-81)  
White Nylon

Moulding Insert  
Head Dia: 11.5mm  
Stem Length: 12mm  
Fits Into 9mm Hole  
Body Styles  
170, 202, 203, 208, 210 & 220  
1994 - On

UNIT PACKAGE: 25



**20659**  
(201-997-22-81)  
White Nylon

Hood & Trunk  
Moulding Insert  
Head Diameter: 7mm  
Stem Length: 6mm  
Fits Into 5.5mm Hole  
C, CL, CLK, E, SLK & S Class  
1996 - On

UNIT PACKAGE: 15



**20200**  
(001-988-77-81)  
Natural Nylon

Moulding Insert  
Head Dia: 8mm  
Stem Length: 5mm  
Fits Into 7mm Hole  
Body Styles  
202 & 210  
1994 - On

UNIT PACKAGE: 25



**13141**  
(000-988-15-81)  
Red Nylon

Moulding Insert  
UNIT PACKAGE: 50



**13144**  
(000-988-55-81)  
Blue Nylon

Moulding Insert  
UNIT PACKAGE: 50

# Sec. 22 MERCEDES-BENZ CLIPS & FASTENERS



**13157**  
(000-987-10-81)  
White Nylon

Moulding Insert  
UNIT PACKAGE: 50



**16124**  
(001-988-20-81)  
Red Nylon

Tubular Nut  
I.D.: 4.5mm, Length: 14mm  
Fits Into 9mm Hole  
UNIT PACKAGE: 50



**13150**  
(123-997-03-81)  
Nylon

Barrel Nut  
For 2mm Stud  
Fits Into 4mm Hole  
UNIT PACKAGE: 50



**20647**  
(000-988-16-25)  
White Nylon

Cowl Vent Nylon Nut  
M3.5 (#6) Screw Size  
Head Size: 9.5mm x 9.5mm  
Stem Length: 14mm  
Fits Into 6.5mm x 7mm Hole

UNIT PACKAGE: 25



**20646**  
(001-988-12-25)  
Natural Nylon

M3.5 (#6) Screw Size  
Head Diameter: 12mm  
Stem Length: 20mm  
Fits Into 5.5mm Hole

UNIT PACKAGE: 10



**20404**  
(000-988-86-25)  
Natural Nylon

Rocker Panel Moulding  
Screw Grommet  
Use With M4.2 (#8) Screw  
Class CL, E & S  
1996 - On

UNIT PACKAGE: 25



**20315**  
(673-988-00-25)  
Black Nylon

Screw Grommet  
#8 (M4.2) Screw Size  
Head Diameter: 25mm  
Stem Length: 17mm  
Body Styles  
124, 126, 170, 201,  
202, 208 & 210  
1991 - On

UNIT PACKAGE: 15



**13145**  
(000-988-23-78)  
Black Metal

Panel Fastener  
UNIT PACKAGE: 25



**20644**  
(003-988-19-78,  
201-988-25-78)  
Natural Nylon

Grille Retainer  
Head Size: 4mm x 6.5mm  
Stem Diameter: 4mm  
Stem Length: 8mm

UNIT PACKAGE: 25



**13148**  
(000-987-10-15)  
White Nylon

Retaining Clip  
UNIT PACKAGE: 25



**20643**  
(000-997-91-86)  
Black Nylon

Retainer  
Head Diameter: 13mm  
Stem Diameter: 6.5mm  
Stem Length: 11mm

UNIT PACKAGE: 10



**21105**  
(001-988-03-25)  
Black Nylon

Hood Insulation Retainer  
Head Diameter: 20mm  
Stem Diameter: 14mm  
Stem Length: 10mm  
Mercedes - Benz  
2002 - On

UNIT PACKAGE: 15



**20188**  
(003-988-41-78)  
White Nylon

Trim Panel Retainer  
Small Head Dia: 13mm  
Large Head Dia: 18mm  
Stem Diameter: 8.5mm  
Stem Length: 11mm  
Body Styles 107, 108,  
109, 114, 115, 123 & 124  
1995 - 68

UNIT PACKAGE: 10



**20735**  
(463-933-02-78)  
Black Nylon

Door Panel Retainer  
Top Head Diameter: 11.5mm  
Bottom Head Diameter: 18mm  
Stem Diameter: 9mm  
Stem Length: 14mm  
G55 & G500  
2002 - On

UNIT PACKAGE: 25





**20642**  
 (000-990-57-92)  
 Gray Nylon  
 Door Panel Retaining Clip  
 Top Head Diameter: 13mm  
 Bottom Head Diameter: 16mm  
 Stem Diameter: 9mm  
 Stem Length: 13mm  
 UNIT PACKAGE: 10



**21037**  
 (000-990-84-92)  
 Black Nylon  
 Push-Type Retainer  
 Head Diameter: 10mm  
 Stem Length: 10mm  
 Fits Into 6mm Hole  
 Mercedes - Benz  
 2005 - On



**21044**  
 (123-990-05-92,  
 126-990-03-92)  
 Black Nylon  
 Cowl Screen Cover  
 Push-Type Retainer  
 Head Diameter: 16mm  
 Stem Length: 11mm  
 Fits Into 6.3mm Hole  
 E, CL & S Class  
 2000 - On



**20879**  
 (007-988-99-78,  
 007-988-34-78)  
 Green Nylon  
 Door Trim Panel Retainer  
 Top Head Diameter: 13mm  
 Bottom Head Diameter: 17mm  
 Stem Diameter: 9mm  
 Stem Length: 14mm  
 Mercedes-Benz  
 1996 - On



**20314**  
 (000-990-37-92)  
 Black Nylon  
 Trunk Trim &  
 General Purpose  
 Push-Type Retainer  
 Head Diameter: 13mm  
 Stem Length: 14mm  
 Fits Into 8mm Hole  
 SL500 & SL600 Convertible  
 1999 - On



**20641**  
 (000-990-46-92)  
 Black Nylon  
 Push-Type Retainer  
 Head Diameter: 17mm  
 Stem Length: 15mm  
 Fits Into 6mm Hole  
 UNIT PACKAGE: 10



**13230**  
 (Mercedes  
 000-990-03-92;  
 Volvo: 947-098)  
 Black Nylon  
 Push-Type Retainer  
 Head Dia. 10mm  
 Stem Length: 7mm  
 Fits Into 5mm Hole  
 UNIT PACKAGE: 50



**20640**  
 (000-990-40-92,  
 124-990-05-92-9051)  
 Black Nylon  
 Push-Type Retainer  
 Head Diameter: 12mm  
 Stem Length: 11mm  
 Fits Into 5mm Hole  
 UNIT PACKAGE: 25



**20636**  
 (123-990-00-92)  
 Dark Gray Nylon  
 Push-Type Retainer  
 Head Diameter: 12mm  
 Stem Length: 10mm  
 Fits Into 8.5mm Hole  
 UNIT PACKAGE: 15



**20187**  
 (000-990-34-92)  
 Black Nylon  
 Radiator Housing  
 Push-Type Retainer  
 Head Diameter: 10mm  
 Stem Length: 10mm  
 Fits Into 6mm Hole  
 Body Styles 116, 123, 124, 126,  
 129, 140, 170, 201, 208 & 210  
 1974 - On  
 UNIT PACKAGE: 15



**20639**  
 (000-990-44-92)  
 Black Nylon  
 Push-Type Retainer  
 Head Diameter: 12mm  
 Stem Length: 11mm  
 Fits Into 5mm x 5mm Hole  
 UNIT PACKAGE: 25



**20772**  
 (001-990-13-92)  
 Black Nylon  
 Back Glass Moulding  
 Push-Type Retainer  
 Head Diameter: 15mm  
 Stem Length: 11mm  
 Fits Into 5mm Hole  
 C & SL Class  
 2001 - On  
 UNIT PACKAGE: 15

# Sec. 22 MERCEDES-BENZ CLIPS & FASTENERS



**20909**

(124-990-04-92)  
Black Nylon

Push-Type Retainer  
Head Diameter: 16mm  
Stem Length: 18mm  
Fits Into 7mm Hole  
Mercedes-Benz  
2003 - On

UNIT PACKAGE: 15



**20203**

(124-990-07-92)  
Black Nylon

Push-Type Retainer  
Head Size: 11mm x 14mm  
Stem Length: 8mm  
Fits Into 7mm x 8mm Hole  
Body Styles  
124, 129, 140, 170, 202,  
203, 208, 210, 215, & 220  
1986 - On

UNIT PACKAGE: 25



Not Actual Size

**20655**

(114-997-02-90)  
Black Nylon

Cable Strap  
Overall Length: 160mm (6-1/2")  
Fits Into 8mm Hole

UNIT PACKAGE: 10



**20637**

(123-990-02-92)  
Black Nylon

Push-Type Retainer  
Head Diameter: 20mm  
Stem Length: 9mm  
Fits Into 8mm Hole

UNIT PACKAGE: 10



**20645**

(201-990-00-50)  
Black Nylon

Rear Compartment  
Carpet Retainer  
Fits Onto 5mm Stud  
Head Diameter: 24mm  
10mm Hex

UNIT PACKAGE: 25



**13152**

(000-994-13-45)  
Metal

Snap-In Nut  
M4.2 (#8) Screw Size

UNIT PACKAGE: 50



**21086**

(230-990-01-92)  
Black Nylon

Hood Insulation  
Push-Type Retainer  
Head Diameter: 20mm  
Stem Length: 10mm  
Fits Into 8mm Hole  
GL, M, R,  
SL & SLK  
2005 - On

UNIT PACKAGE: 15



**20653**

Gray Nylon

Wire Routing Clip  
Inside Diameter: 7mm x 10mm  
Fits Into 6mm Hole  
BMW & Mercedes

UNIT PACKAGE: 50



**20652**

(123-994-03-45)  
Zinc & Yellow

M6.5 Tapping Screw Size  
15mm x 30mm

UNIT PACKAGE: 25



**20648**

(123-994-01-45)  
Zinc & Yellow

M2.9 (#4) Screw Size  
Panel Range: .7mm - 1.5mm  
Center of Hole to Edge: 4mm

UNIT PACKAGE: 50



**20638**

(201-990-02-92)  
Black Nylon

Push-Type Retainer  
Head Diameter: 20mm  
Stem Length: 14mm  
Fits Into 8.5mm Hole

UNIT PACKAGE: 25



**20654**

(001-997-42-90)  
Black Nylon

Cable Strap  
Overall Length: 120mm (4-3/4")  
Fits Into 8mm Hole

UNIT PACKAGE: 10



**20649**

Zinc & Yellow

M3.5 (#6) Screw Size  
Panel Range: .5mm - 1.5mm  
Center of Hole to Edge: 8mm

UNIT PACKAGE: 50



**13223**

(BMW: 0712-9-925-708;  
Mercedes: 000-994-25-45)  
Plated

"U" Type Nut  
4.2mm (#8) Screw Size  
Panel Range: 3mm-4mm  
Center of Hole To Edge: 7mm  
UNIT PACKAGE: 50



**13224**

(000-994-04-45)  
Plated

"U" Type Nut  
4.2mm (#8) Screw Size  
Panel Range: .5mm-1.7mm  
Center of Hole To Edge: 8mm  
UNIT PACKAGE: 50



**20650**

(123-994-08-45)  
Zinc & Yellow

M4.2 (#8) Screw Size  
Panel Range: .5mm - 2.5mm  
Center of Hole to Edge: 14mm

UNIT PACKAGE: 25



**13218**

(BMW: 0712-9-925-737;  
Mercedes 000-994-06-45)  
Plated

"U" Type Nut  
4.8mm Screw Size  
Panel Range: .5mm-1.7mm  
Center of Hole To Edge: 7mm  
UNIT PACKAGE: 50



**13215**

(BMW: 0711-9-916-945,  
Mercedes 000-994-14-45)  
Plated

"U" Type Nut  
4.8mm Screw Size  
Panel Range: .8mm-1.7mm  
Center Of Hole To Edge: 11mm

UNIT PACKAGE: 50



**13216**

Zinc

"U" Type Nut  
4.8mm Screw Size  
Panel Range: .9mm-2.0mm  
Center of Hole to Edge: 8mm

UNIT PACKAGE: 25



**13220**

(Mercedes:  
000-994-09-45;  
Volvo: 946-418;  
Opel: 20-72-175)  
Plated

"U" Type Nut  
6.3mm Screw Size  
Panel Range: .7mm-1.5mm  
Center of Hole To Edge: 13mm

UNIT PACKAGE: 50

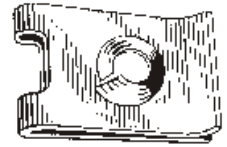

**13222**

(Mercedes 000-994-50-45;  
BMW 0712-9-925-730;  
VW: N15.457.1;  
Opel: 20-72-175)  
Plated

6.5mm Screw Size  
Panel Range: .7mm-1.5mm  
Center of Hole to Edge: 13mm

UNIT PACKAGE: 50



**20651**

(001-990-00-91)  
Zinc

M6 - 1.0 Screw Size  
Panel Range: .5mm - 1.7mm  
Center of Hole To Edge: 15mm

UNIT PACKAGE: 10

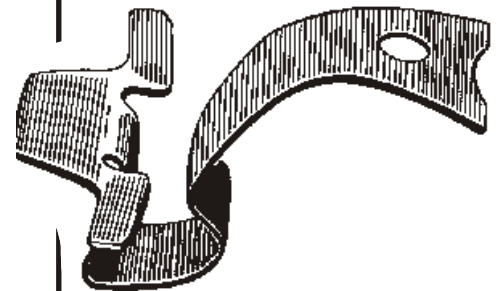

**13149**

(123-401-01-28)  
Plated Metal

Hub Cap Clip

UNIT PACKAGE: 10

**MINI-COOPER**



**20570**

(Mini-Cooper: 07-13-0-702-715;  
Honda: 75307-SN7-000)

Wheel Opening  
Nylon Moulding Nut  
With Brass Insert  
M4-0.7 Thread  
12mm Flange O.D.  
10mm Hex  
Height: 11mm

UNIT PACKAGE: 15

**MITSUBISHI**



**19343**

(MB608137)  
Natural Nylon

Windshield Moulding Clip  
Diamante  
1995-91

UNIT PACKAGE: 15



**19473**

(MR154127)  
Teal Nylon

Windshield Moulding Clip  
Diamante  
1997-On

UNIT PACKAGE: 10



**19474**

(MR154128)  
Natural Nylon

Windshield Moulding Clip  
Diamante  
1997-On

UNIT PACKAGE: 15



**19475**

(MB608156)  
Natural Nylon

Windshield Moulding Clip  
With Adhesive Backing  
Diamante  
1996-91

UNIT PACKAGE: 10



**19342**

(MB608134)  
Nylon

Windshield & Rear Window  
Reveal Moulding Clip  
Diamante  
1995-91

UNIT PACKAGE: 15



**17295**

(MB-198536)  
Nylon

Windshield Moulding Clip  
Mitsubishi 1984-On  
Dodge Conquest 1984-On

UNIT PACKAGE: 25



**19745**

(MB880455)  
Yellow Nylon

Windshield Moulding Clip  
Montero  
1992-On

UNIT PACKAGE: 10



**19314**

(MB814419)  
Nylon

Drip Moulding  
& Garnish  
Moulding Clip  
Galant  
1993-On

UNIT PACKAGE: 25



**17195**

Black Nylon

Grille Clip  
13mm Wide  
22mm Long  
Ford Escort, Honda,  
Isuzu, Mitsubishi & Plymouth Laser

UNIT PACKAGE: 25



**20572**

(MB846992)  
White Nylon

Rocker Panel Retainer  
Top Head Diameter: 12mm  
Bottom Head Diameter: 16mm  
Stem Length: 14mm  
Fits Into 7mm Hole  
Montero  
2001 - On

UNIT PACKAGE: 10



**19330**

(MB608140)  
White Nylon

Trunk Air Dam  
Side Moulding Clip  
Diamante  
1991-On

UNIT PACKAGE: 10



**14255**

(Mitsubishi: MS-480001;  
Honda: 75522-611-0000;  
Mazda: 9991-00-412)

Black Nylon

#8 Screw Size  
9.5mm Wide  
9.5mm Long

Snaps Into 7mm x 7mm Hole

UNIT PACKAGE: 50



**19487**

(MB419858)  
Natural Nylon

Scuff Plate Screw Grommet  
#6 Screw Size  
Diamante  
1995-91

UNIT PACKAGE: 15



**13932**

(Mitsubishi: MS-480002;  
Toyota: 90189-05013)  
Natural Nylon

#10 Screw Size  
12mm Wide  
12mm Long

Fits Into 8mm x 9mm Hole

UNIT PACKAGE: 50



**19485**

Natural Nylon

#14 (M6.3) Screw Size  
Fits Into 3/8" x 3/8" Hole  
Eclipse

UNIT PACKAGE: 10



**20573**

(MB817060)  
White Nylon

Headliner Nylon Nut  
Head Diameter: 15mm  
Inside Diameter: 6mm  
Stem Length: 11mm  
Fits Into 9mm Hole  
Montero  
1997 - On

UNIT PACKAGE: 15



**14335**

(Mitsubishi: MB-106212;  
Nissan: 96706-H9400,  
-K1300,-K1351)  
Natural Nylon

Screw Grommet  
#8 Screw Size  
Head Diameter: 13.5mm  
Stem Length: 16mm  
Fits Into 6mm x 6mm Hole

UNIT PACKAGE: 50



**14695**

(Mitsubishi: MS-480012;  
Honda: 90661-SC7-0030;  
Mazda: H001-50-841;  
Nissan: 01651-00481, 74798-S9000;  
Toyota: 90189-06042)  
White Nylon

Screw Grommet  
#8 Screw Size  
Head Diameter: 16mm  
Stem Length: 17mm  
Fits Into 8mm x 8mm Hole

UNIT PACKAGE: 25



**19322**

(MU480034)  
Natural Nylon

Rear Side & Trunk Trim  
Screw Grommet  
#8 Screw Size  
Eclipse  
1994-On

UNIT PACKAGE: 15



**14275**

(Mitsubishi: MB-098145;  
Nissan: 01281-00023;  
Toyota: 90189-06001)  
White Nylon

Screw Grommet  
#10 Screw Size  
Head Diameter: 18mm  
Stem Length: 17mm  
Fits Into 8.5mm x 8.5mm Hole  
UNIT PACKAGE: 25



**19324**

(MB888561)  
Natural Nylon

Drip Moulding Screw Grommet  
#8 Screw Size  
Eclipse  
1994-On  
UNIT PACKAGE: 25



**20381**

(Honda: 90667-671-013ZA;  
Mitsubishi: MC440901;  
Nissan: 62660-48600-1)  
Black Nylon

Trim Panel Retaining Clip  
Head Diameter: 16mm  
Stem Diameter: 7mm  
Stem Length: 16mm  
Honda, Mitsubishi &  
Nissan  
UNIT PACKAGE: 25



**20581**

(MR478263)  
Black Rubber

Bumper Cover &  
Garnish Moulding Grommet  
With Sealer  
Head Diameter: 16mm  
Stem Length: 20mm  
Fits Into 9mm Hole  
Use With Auveco 20580  
Chrysler Sebring & Stratus  
And Mitsubishi Eclipse  
2000 - On  
UNIT PACKAGE: 15



**21025**

(MB645307)  
Black Nylon

Back Glass Lower Moulding,  
Quarter Glass Moulding &  
Spoiler Grommet With Sealer  
Head Size: 12mm x 16mm  
Stem Length: 14mm  
Dodge Avenger & Stealth and  
Chrysler Sebring  
1991 - On  
Mitsubishi  
1991 - On  
UNIT PACKAGE: 15



**14720**

(HB-121467)  
Black Nylon

Retaining Clip  
Head Diameter: 18mm  
Shank Length: 15mm  
Snaps Into 8mm Hole  
Panel Thickness: 5mm  
UNIT PACKAGE: 25



**19323**

(MU481187)  
Black Nylon

Hood Insulation Retainer  
Head Diameter: 26mm  
Stem Diameter: 10mm  
Stem Length: 8mm  
Diamante  
1993-On  
UNIT PACKAGE: 15



**20565**

(MB271999)  
Black Nylon

Bumper Cover Grommet  
Head Diameter: 24mm  
Stem Length: 21mm  
Fits into 13mm Hole  
Chrysler Colt, Eagle, Sebring  
& Stratus 1989 - On  
Mitsubishi Eclipse, Galant  
& Mirage 1993 - On  
UNIT PACKAGE: 10



**19331**

(MB869072)  
Black Nylon

Headliner & Trunk Trim  
Retaining Clip  
Head Diameter: 14mm  
Stem Length: 11mm  
Fits Into 7mm Hole  
Diamante  
1995-91  
UNIT PACKAGE: 15



**19385**

(MB020923)  
Gray Nylon

Hood Insulation Retainer  
Head Diameter: 26mm  
Stem Diameter: 10mm  
Stem Length: 8mm  
Jeep Eagle &  
Mitsubishi Eclipse  
1992-On  
UNIT PACKAGE: 10



**19334**  
(MB566720)  
Natural Nylon

Rear Pillar Trim &  
Air Inlet Grille Retainer  
Small Head Diameter: 12mm  
Large Head Diameter: 16mm  
Stem Diameter: 9mm  
Stem Length: 15  
Eclipse  
1994-On

UNIT PACKAGE: 15



**19325**  
(MU481027)  
Brown Nylon

Hood Weatherstrip  
Retainer  
Head Size: 5mm x 13mm  
Stem Diameter: 7mm  
Stem Length: 6mm  
Eclipse & Diamante  
1991-On

UNIT PACKAGE: 25



**20247**  
(MR200300)  
Black Nylon

Fender & Bumper  
Push-Type Retainer  
Head Diameter: 18mm  
Stem Length: 12mm  
Fits Into 9mm Hole  
Honda & Mitsubishi  
1998 - On

UNIT PACKAGE: 15



**19320**  
(MB696120)  
White Nylon

Side Garnish &  
Moulding Trim Retainer  
Small Head Diameter: 12mm  
Large Head Diameter: 16mm  
Stem Diameter: 9mm  
Stem Length: 11mm  
Eclipse  
1994-On

UNIT PACKAGE: 15



**20580**  
(MR478262)  
Black Nylon

Bumper Cover &  
Garnish Moulding  
Push-Type Retainer  
Top Head Diameter: 15mm  
Bottom Head Diameter: 14mm  
Stem Length: 12mm  
Fits Into 7mm Hole  
Use With Auveco 20581  
Chrysler Sebring & Stratus  
And Mitsubishi Eclipse  
2000 - On

UNIT PACKAGE: 15

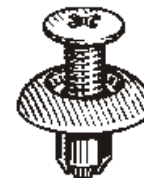

**17351**  
(MB-253964)  
Black Nylon

Front & Rear Bumper  
Push-Type Retainer  
Head Diameter: 17mm  
Stem Length: 10mm  
Fits Into 7mm Hole  
Tredia 1988-83

UNIT PACKAGE: 10



**20571**  
(MR435918)  
White Nylon

Rocker Panel Retainer  
Top Head Diameter: 13mm  
Bottom Head Diameter: 18mm  
Stem Diameter: 9mm  
Stem Length: 9mm  
Montero  
2001 - On

UNIT PACKAGE: 15



**19239**  
(Honda: 91512-SX0-003;  
Mitsubishi: MU000319)  
Black Nylon

Front Fender &  
Bumper Support  
Push-Type Retainer  
Head Diameter: 20mm  
Stem Length: 11mm  
Fits Into 8mm Hole  
Acura 3.5RL, Honda Accord,  
Prelude & Odyssey  
1994-On  
Mitsubishi Lancer  
2002-On

UNIT PACKAGE: 25

View the Auveco  
catalog on-line at  
[www.auveco.com](http://www.auveco.com).

You can search by  
Auveco part number,  
description, OEM  
number and  
competitive part  
number.



**17472**  
 (Mitsubishi: MB547806;  
 Nissan: 63854-01A00)  
 Black Nylon  
 Front Bumper Fascia  
 Push-Type Retainer  
 Head Diameter: 20mm  
 Stem Length: 20mm  
 Fits Into 8mm Hole

UNIT PACKAGE: 15



**18951**  
 (MR-138807)  
 Black Nylon  
 Front Bumper  
 & Support  
 Push-Type Retainer  
 Head Diameter: 20mm  
 Stem Length: 26mm  
 Fits Into 8mm Hole  
 Eclipse 1994-On  
 UNIT PACKAGE: 5



Not Actual Size

**20380**  
 Not Supplied By O.E.M.  
 Black Nylon

Cable Strap  
 Length: 200mm (8")  
 5mm (3/16") Wide  
 Max. Bundle Dia: 44mm (1-3/4")  
 Fits Into 6.3mm (1/4") Hole  
 Import Cars

UNIT PACKAGE: 25



**19140**  
 (Acura: 90505-SL0-003;  
 GM: 94852638;  
 Mitsubishi: MB888869;  
 Toyota: 90467-08155)  
 Black Nylon  
 Push-Type Retainer  
 Head Diameter: 20mm  
 Stem Length: 21mm  
 Fits Into 8mm Hole  
 Acura, Dodge Avenger,  
 Eagle Talon, Geo Prizm, Mitsubishi  
 Eclipse & Galant  
 and Toyota 1993-On  
 UNIT PACKAGE: 5



**19328**  
 (MR201466)  
 White Nylon  
 Trunk Trim Cap  
 Eclipse  
 1994-On  
 UNIT PACKAGE: 15



**13225**  
 Plated  
 "U" Type Nut  
 4.2mm (#8) Screw Size  
 11mm Wide 16.5mm Long  
 Panel Range: .5mm-2.5mm  
 Center of Hole to Edge: 8mm  
 UNIT PACKAGE: 50

HELPFUL HINTS.....

FOR USING THE AUVECO CATALOG

1. The color-coded pages signify various sections:  
 BLUE-Metric Items  
 BEIGE-Electrical Accessories  
 GREEN-Assortments, Cabinets, Bins & Racks  
 GRAY-Key Blanks & Accessories  
 PINK-Import Car Body Hardware
2. Most illustrations are actual size. You should be able to set a part on top of the illustration to positively identify it.
3. Our Display Boards, which are shown on the four-color pages in the front of the catalog, are a great aid in identifying product.
4. We have three different indexes in the front of the catalog to assist you.  
 PICTORIAL QUICK INDEX  
 ALPHABETICAL INDEX  
 NUMERICAL INDEX
5. There are two OEM Part Number To AUVECO Part Number Cross References at the back of the catalog.





**21085**  
Not Available  
From O.E.M.  
Light Blue Nylon

Rocker Panel  
Moulding Clip  
Overall Height: 15mm  
Stem Length: 9mm  
Murano  
2003 - On

UNIT PACKAGE: 15



**20614**  
(66820-3S510)  
White Nylon

Cowl Vent Retainer  
Head Size: 10mm x 18mm  
Stem Diameter: 6mm  
Stem Length: 13mm  
Frontier & Xterra  
1998 - On

UNIT PACKAGE: 25



**20674**  
(85284-AD005)  
Black Nylon

Rear Bumper Retainer  
With Sealer  
Head Diameter: 18mm  
Stem Length: 21mm  
Overall Length: 38mm  
Quest  
2004 - On

UNIT PACKAGE: 10



**20873**  
(73858-8J000)  
Black Nylon

Drip Rail Moulding Clip  
Width: 13.5mm  
Length: 31mm  
Nissan  
2000 - On

UNIT PACKAGE: 10



**12583**  
(76884-90100)  
Nylon

Step Moulding Clip  
24mm Wide  
14mm Long  
Snaps Into 8mm Hole

UNIT PACKAGE: 15



**14333**  
(79896-P7100)  
Nylon

Moulding Clip  
27mm Wide; 25mm Long  
Fits Into 14mm x 16mm Hole

UNIT PACKAGE: 10



**12585**  
(255 Y 3616-10)  
Nylon

Side Window Moulding Clip  
12mm Wide  
12mm Long  
Snaps Into 5mm Hole

UNIT PACKAGE: 15



**15468**  
(72826-01P00)  
Nylon

Windshield Moulding Clip  
11mm Wide, 40mm Long  
300ZX 1984-On

UNIT PACKAGE: 15



**20961**  
Not Available From O.E.M.  
White Nylon

Drip Moulding Clip  
With Sealer  
Top Width: 25mm  
Overall Height: 16mm  
Fits Into 5mm Hole  
Infiniti M45, I30 & G35  
2005 - On  
Nissan Altima, Maxima  
& 350Z  
2002 - On

UNIT PACKAGE: 15



**21117**  
(85284-CD000)  
White Nylon

Bumper Retainer  
With Sealer  
Head Diameter: 22mm  
Stem Length: 21mm  
Overall Length: 39mm  
Nissan  
2004 - On

UNIT PACKAGE: 10

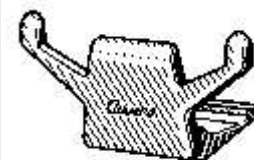

**17348**  
(73856-51E00)  
Nylon

Roof Side Moulding Clip  
Stanza 1990-On

UNIT PACKAGE: 25

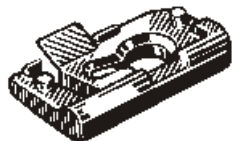

**15469**  
Nylon

Windshield Reveal Moulding Clip  
15mm Wide, 25.5mm Long  
Nissan & Mazda  
UNIT PACKAGE: 25



**17349**  
(79796-71E00)  
Nylon

Window Reveal Moulding Clip  
Back Glass  
Maxima  
1990-On  
UNIT PACKAGE: 25

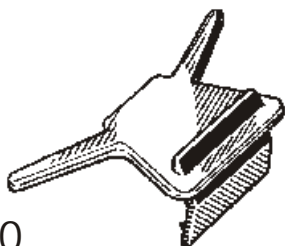

**15470**  
(72727-W1000)  
White Nylon

Windshield Reveal Moulding Clip  
21mm Wide, 40mm Long  
UNIT PACKAGE: 15



**21097**  
Not Available From O.E.M.  
Black Nylon

Windshield Moulding Clip  
Width: 22mm  
Length: 46mm  
Altima 2004 - On  
UNIT PACKAGE: 25

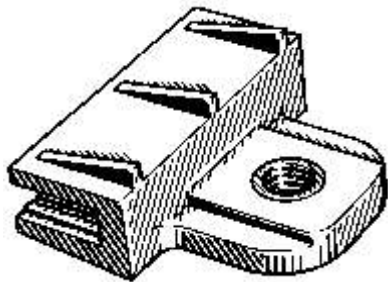

**18113**  
(69951-12180)  
Nylon With  
Steel Threaded Insert

Glass Mount  
M6-1.0 Thread  
Nissan, Ford & Imports  
UNIT PACKAGE: 5

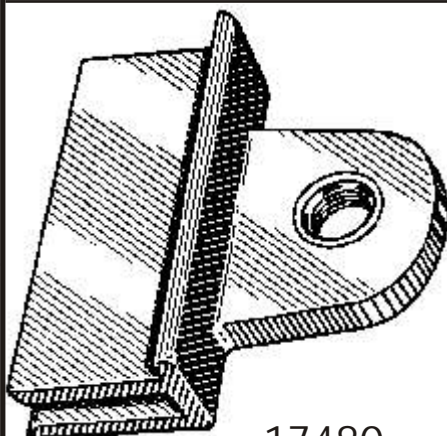

**17480**  
Nylon With Steel Threaded Insert  
Glass Mount  
M6-1.0 Thread  
Pathfinder & 850 Pick-Up Truck  
1986-On

UNIT PACKAGE: 2

Not Actual Size



**21108**  
(62228-7Y000)  
Black Nylon

Front Bumper Cover  
Width: 40mm  
Length: 93mm  
Maxima & Quest  
2004 - On  
UNIT PACKAGE: 5



**21018**  
(26398-2Y001)  
White Nylon

Headlight Housing Clip  
Width: 25mm  
Length: 38mm  
Stem Length: 11mm  
Sentra  
2000 - On  
UNIT PACKAGE: 5



**16549**  
(26025-N8500)  
Black Nylon

Headlight Adjusting Screw Nut  
200SX, 210,  
620 & 720 1980-On  
UNIT PACKAGE: 25



**13931**  
(26023-H1000)  
White Nylon

Screw Grommet  
For Headlight Adjusting Screws  
Use With 5mm Screws  
14mm Wide  
14mm Long  
UNIT PACKAGE: 50



**13930**  
(Nissan: 96706-B0700;  
Mazda: 9991-00-412)  
White Nylon

#8 Screw Size  
9.5mm Wide 9.5mm Long  
Snaps Into 7mm x 7mm Hole  
UNIT PACKAGE: 50



**14274**  
(Mazda: 9991-00-601;  
Honda: 75521-611-0000;  
Nissan: 96706-P0105;  
Toyota: 90189-06010)  
Natural Nylon

#10 Screw Size  
13mm Wide; 13mm Long  
Snaps Into 8.5mm x 8.5mm Hole  
UNIT PACKAGE: 25



**19897**

(76881-9E000)  
Green Nylon

Door Panel Sash  
Screw Grommet  
M4.2 (#8) Screw Size  
Head Size: 10mm Sq.  
Stem Length: 8mm  
Maxima  
1999 - On

UNIT PACKAGE: 25



**14334**

(96706-N8000)  
Natural Nylon

#8 Screw Size  
12mm Wide; 15mm Long  
Fits Into 8mm x 12mm Hole

UNIT PACKAGE: 25



**14313**

(Nissan: 68425-H5000;  
Honda: 90662-671-0030;  
Mazda: 9991-00-503)  
Natural Nylon

#10 Screw Size  
17mm Wide; 17mm Long  
Snaps Into 8mm x 8.5mm Hole

UNIT PACKAGE: 25



**20764**

(01281-00831)  
Natural Nylon

Bumper, Fender & Light  
Screw Grommet  
M4.2 (#8) Screw Size  
Head Diameter: 16mm  
Stem Length: 10mm  
Fits Into 9mm x 9mm Hole  
Nissan 240SX, Altima,  
Frontier, Maxima, Pathfinder,  
Quest & Xterra And Infiniti  
1989 - On

UNIT PACKAGE: 25



**14331**

(01281-00022)  
Natural Nylon

#10 Screw Size  
Head Diameter: 13mm  
Fits Into 8mm x 8mm Hole

UNIT PACKAGE: 50



**17342**

(01281-00441)  
Black Nylon

Front Bumper Apron  
Nylon Nut  
#10 Screw Size  
15mm Head Diameter  
Snaps Into 8mm x 8mm Hole  
Stanza  
1990-On

UNIT PACKAGE: 25



**20266**

(62319-0W000)  
Natural Nylon

Front Bumper  
Nylon Nut  
M5.5 (#12) Screw Size  
Head Dia: 16mm  
Stem Length: 11mm  
Frontier Truck  
1997 - On

UNIT PACKAGE: 10



**20673**

(80874-0P000)  
White Nylon

Cowl Vent Grommet  
With Sealer  
Head Size: 13mm x 13mm  
Stem Length: 13mm  
Use With Auveco 17633  
Nissan & Infiniti  
1997 - On

UNIT PACKAGE: 15



**20257**

(76848-50Y00)  
Blue Nylon

Windshield Moulding  
Screw Grommet  
Head Size: 12mm x 16mm  
Stem Length: 12mm  
M3.5 (#6) Screw Size  
Maxima  
1999 - On

UNIT PACKAGE: 10



**14724**

(96706-H2500)  
Natural Nylon

Screw Grommet  
#6 Screw Size  
Head Diameter: 11.5mm  
Stem Diameter: 9.5mm  
Fits Into 7mm x 7mm Hole

UNIT PACKAGE: 25



**14366**

(Nissan: 96706-89901;  
Mazda: 9991-00-402)  
Natural Nylon

Screw Grommet  
#6 Screw Size  
9.5mm Wide; 9.5mm Long  
Stem Length: 16mm  
Fits Into 7mm x 7mm Hole

UNIT PACKAGE: 50



**14335**

(Nissan: 96706-H9400;  
-K1300, -K1351;  
Mitsubishi: MB-106212)  
Natural Nylon

Screw Grommet  
#4 Screw Size  
Head Diameter: 13.5mm  
Stem Length: 16mm  
Fits Into 6mm x 6mm Hole

UNIT PACKAGE: 50



**20258**  
(01281-00741)  
Natural Nylon

Floor Trim  
Screw Grommet  
Head Dia: 11mm  
Stem Length: 13mm  
M3.5 (#6) Screw Size  
Quest  
1998 - On

UNIT PACKAGE: 10



**19293**  
(01281-00601)  
Natural Nylon

Body Side Moulding  
Floor & Trunk  
Screw Grommet  
#10 Screw Size  
Maxima, Sentra,  
240SX & 300ZX  
1986-On

UNIT PACKAGE: 15



**14690**  
(Nissan: 78856-R4301,  
Honda: 90683-693-0000)  
White Nylon

Screw Grommet  
#10 Screw Size  
12mm Wide; 19mm Long  
Stem Length: 17mm  
Fits Into 8mm x 15mm Hole

UNIT PACKAGE: 25



**14695**  
(Nissan: 01651-00481  
74798-S9000;  
Honda: 90661-SC7-0030;  
Mazda: H001-50-841;  
Mitsubishi: MS-480012;  
Toyota: 90189-06042)  
White Nylon

Screw Grommet  
#8 Screw Size  
Head Diameter: 16mm  
Stem Length: 17mm  
Fits Into 8mm x 8mm Hole

UNIT PACKAGE: 25



**21111**  
(01281-00331)  
Natural Nylon

Bumper, Rocker Panel  
& Light Mounting  
Screw Grommet  
With Sealer  
M6.3 (#14) Screw Size  
Head Diameter: 20mm  
Stem Length: 16mm  
Fits Into 10mm Square Hole  
Infiniti  
1997 - On  
Nissan  
1996 - On

UNIT PACKAGE: 25



**20166**  
(76881-0P000)  
Natural Nylon

Window Moulding  
Screw Grommet  
#8 Screw Size  
Head Size: 16mm x 22mm  
Stem Length: 16mm  
Sentra & Stanza  
1994 - On

UNIT PACKAGE: 15



**20604**  
(01281-00711)  
Natural Nylon

Rocker Moulding  
Screw Grommet  
M4.2 (#8) Screw Size  
Head Diameter: 20mm  
Stem Length: 15mm  
Nissan & Infiniti  
1995 - On

UNIT PACKAGE: 10



**20786**  
(76848-8J010)  
Black Nylon

Headlight Assembly Grommet  
Head Size: 17mm x 23mm  
Stem Length: 10mm  
Altima  
2002 - On

UNIT PACKAGE: 10



**14275**  
(Nissan: 01281-00023;  
Mitsubishi: MB-098145;  
Toyota: 90189-06001)  
White Nylon

Screw Grommet  
#10 Screw Size  
Head Diameter: 18mm  
Stem Length: 17mm  
Fits Into 8.5mm x 8.5mm Hole

UNIT PACKAGE: 25



**20736**  
(01281-01081)  
Natural Nylon

Front Bumper Nylon Nut  
M4.8 (#10) Screw Size  
Flange Diameter: 16mm  
Overall Length: 22mm  
Nissan & Infiniti  
1997 - On

UNIT PACKAGE: 15



**17196**  
(62380-U7400)  
Black Nylon

Grille Grommet  
22mm Wide, 26mm Long  
Nissan 1987-On

UNIT PACKAGE: 10



**19736**  
(76988-3J000)  
White Nylon

Kick Plate Retainer Grommet  
Head Size: 14mm x 34mm  
Stem Length: 14mm  
Altima  
1997-On

UNIT PACKAGE: 15



**20790**  
(85222-0M000)  
Black Nylon

Rear Bumper  
Fascia Clip  
With Sealer  
Overall Height: 35mm  
Stem Length: 16mm  
Pathfinder  
2004 - On

UNIT PACKAGE: 5



**19146**  
(01281-00481)  
Natural Nylon

Front Windshield  
Moulding Grommet  
#6 Screw Size  
Pathfinder & Truck  
1986-On

UNIT PACKAGE: 10



**20813**  
(63846-9E000)  
Natural Nylon

Rear Bumper  
Moulding Grommet  
With Sealer  
Head Size: 18mm x 18mm  
Stem Length: 15mm  
Use With Auveco Retainer 20812  
Altima  
2001 - 1998

UNIT PACKAGE: 15



**20812**  
(63848-9E000)  
Black Nylon

Rear Bumper  
Moulding Retainer  
Head Diameter: 20mm  
Overall Length: 19mm  
Use With Auveco Grommet 20813  
Altima  
2001 - 1998

UNIT PACKAGE: 15



**17633**  
(66820-88E00)  
Nylon

Cowl Screen Pin Retainer  
Maxima 1990-On

UNIT PACKAGE: 25



**17634**  
(01553-01781)  
Black Nylon

Cowl Grille Retainer  
Head Dia: 12mm  
Stem Length: 16mm  
Stem Dia: 6mm  
240SX  
1990-On

UNIT PACKAGE: 25



**14355**  
(01553-00401)  
Black Nylon

Retaining Clip  
Head Diameter: 11mm  
Stem Length: 13mm  
Snaps Into 5mm Hole  
Panel Range: 4mm

UNIT PACKAGE: 50



**14349**  
(Mazda: 9926-40-543A;  
Nissan: 01553-00291)  
Black Nylon

Retaining Clip  
Head Diameter: 11mm  
Stem Length: 15mm  
Fits Into 5.5mm Hole  
Panel Thickness: 5mm

UNIT PACKAGE: 50



**14352**  
(76876-W5000)  
Black Nylon

Retaining Clip  
Head Diameter: 13mm  
Stem Length: 13mm  
Fits Into 5mm Hole  
Panel Thickness: 4mm

UNIT PACKAGE: 50



**17452**  
(01553-00545)  
Black Nylon

Bumper Fascia Retainer  
Head Diameter: 13mm  
Stem Length: 15mm  
Fits Into 5mm Hole  
Sentra  
1990-On

UNIT PACKAGE: 25



**14737**  
(Nissan: 01553-00172;  
Toyota: 90467-07050)  
Black Nylon

Retaining Clip  
Head Diameter: 13mm  
Stem Length: 15mm  
Fits Into 5mm Hole  
Panel Thickness: 3mm

UNIT PACKAGE: 25



**14723**  
 (62869-N4700)  
 Black Nylon  
 Retaining Clip  
 Head Diameter: 14mm  
 Stem Length: 11mm  
 Fits Into 6mm Hole  
 Panel Thickness: 4mm  
 UNIT PACKAGE: 25



**14347**  
 (01553-00202)  
 Black Nylon  
 Retaining Clip  
 Head Diameter: 18mm  
 Stem Length: 12mm  
 Snaps Into 7mm Hole  
 Panel Thickness: 4mm  
 UNIT PACKAGE: 50



**20256**  
 (01553-01182)  
 Black Nylon  
 Splash Shield Retainer  
 Head Dia: 15mm  
 Stem Dia: 4.5mm  
 Stem Length: 14mm  
 Frontier Truck  
 1997 - On  
 UNIT PACKAGE: 50



**14353**  
 (76906-T3000)  
 Black Nylon  
 Retaining Clip  
 Head Diameter: 14mm  
 Stem Length: 16mm  
 Snaps Into 6mm Hole  
 Panel Thickness: 5mm  
 UNIT PACKAGE: 50

E-mail Your New  
 Item Suggestions  
 For Individual Products  
 And  
 Assortments To  
[mail@auveco.com](mailto:mail@auveco.com)



**16776**  
 (Honda: 90667-SA0-0030;  
 Nissan: 76996-01P02)  
 Black Nylon  
 Trim Panel Retainer  
 Head Dia: 18mm  
 Stem Length: 20mm  
 Fits Into 6mm Hole  
 UNIT PACKAGE: 25



**14348**  
 (27948-M7002)  
 Black Nylon  
 Retaining Clip  
 Head Diameter: 16mm  
 Stem Length: 15mm  
 Snaps Into 5mm Hole  
 Panel Thickness: 4mm  
 UNIT PACKAGE: 25



**14356**  
 (01553-00051)  
 Black Nylon  
 Retaining Clip  
 Head Diameter: 20mm  
 Stem Length: 16mm  
 Snaps Into 7mm Hole  
 Panel Thickness: 7mm  
 UNIT PACKAGE: 50



**16775**  
 (Honda: 90667-SA7-0030;  
 Nissan: 89427-98070)  
 Black Nylon  
 Trim Panel Retainer  
 Head Dia: 20mm  
 Stem Length: 15mm  
 Fits Into 5mm Hole  
 UNIT PACKAGE: 25



**20381**  
 (Honda: 90667-671-013ZA;  
 Mitsubishi: MC440901;  
 Nissan: 62660-48600-1)  
 Black Nylon  
 Trim Panel Retaining Clip  
 Head Diameter: 16mm  
 Stem Diameter: 7mm  
 Stem Length: 16mm  
 Honda, Mitsubishi & Nissan  
 UNIT PACKAGE: 25



**18948**  
 (Nissan: 01553-0075U;  
 GM: 1644290)  
 Black Nylon  
 Hood Insulation Retainer  
 Head Diameter: 11mm  
 Stem Diameter: 5.5mm  
 Stem Length: 17.5mm  
 Altima & Maxima  
 2002 - On  
 UNIT PACKAGE: 25

Remember....  
 All Items In This  
 Catalog  
 Are Available In Bulk.  
 Call For A Quote



**17237**  
(65832-F5000,  
65846-30F00)  
Black Nylon

Hood Insulation Retainer  
O.D.: 38mm  
Stem Dia: 7mm  
Stem Length: 9mm  
Nissan 1981-On

UNIT PACKAGE: 15



**20672**  
(66820-3S500-C1)  
White Nylon

Cowl Vent Retainer  
Top Head Diameter: 13mm  
Bottom Head Diameter: 16mm  
Stem Diameter: 4mm  
Stem Length: 13mm  
Frontier & Xterra  
1998 - On

UNIT PACKAGE: 25



**20669**  
(01553-07111)  
Black Nylon

Trim Panel Retainer  
Top Head Diameter: 13mm  
Middle Head Diameter: 15mm  
Bottom Head Diameter: 18mm  
Stem Diameter: 9mm  
Stem Length: 15mm  
Nissan Altima and Infiniti G35 & Q45  
1997 - On

UNIT PACKAGE: 25



**19731**  
(84915-0W000)  
White Nylon

Trim Panel Retainer  
Top Head: 13mm  
Middle Head: 16mm  
Bottom Head: 17mm  
Fits Into 8mm Hole  
Pathfinder  
1995 - On

UNIT PACKAGE: 15



**20668**  
(01553-09791)  
White Nylon

Trim Panel Retainer  
Top Head Diameter: 13mm  
Middle Head Diameter: 16mm  
Bottom Head Diameter: 18mm  
Stem Diameter: 9mm  
Stem Length: 14mm  
Nissan & Infiniti  
1999 - On

UNIT PACKAGE: 15



**20670**  
(01553-02821)  
Gray Nylon

Trim Panel Retainer  
Top Head Diameter: 13mm  
Middle Head Diameter: 16mm  
Bottom Head Diameter: 18mm  
Stem Diameter: 8.5mm  
Stem Length: 12mm  
Maxima  
1988 - On

UNIT PACKAGE: 15



**13945**  
(01553-S3500)  
White Nylon

Door Trim  
Panel Retainer  
Trucks

UNIT PACKAGE: 50



**18166**  
(80875-85E00)  
Black Nylon

Trim Panel Retainer  
Head Diameter: 10mm  
Stem Length: 10mm  
Stem Diameter: 4mm  
Maxima 1989-On

UNIT PACKAGE: 25



**19724**  
(65810-K2009)  
White Nylon

Hood To Cowl Seal Retainer  
Head Size: 6mm x 16mm  
Stem Length: 15mm  
Fits Into 5mm Hole  
Infiniti & Pathfinder  
1992 - On

UNIT PACKAGE: 25



**19684**  
(01553-09311)  
Blue Nylon

Weatherstrip Retainer  
Head Size: 7mm x 16mm  
Stem Length: 12mm  
Fits Into 6mm Hole  
Altima &  
Sentra 1994-On

UNIT PACKAGE: 25



**16860**  
(62318-01W00)  
Nylon

Grille Clip  
Dark Gray

UNIT PACKAGE: 25



**19738**  
(80897-10Y00)  
Natural Nylon

Door Panel Clip  
Width: 12mm  
Length: 25mm  
Stem Length: 16mm  
Fits Into 6mm Hole  
Altima, Infiniti & Sentra  
1997 - On

UNIT PACKAGE: 15

**Remember  
All Items Are Available  
In Bulk.  
Call For A Quote**



**16783**

(66824-01G00)  
Black Nylon

Push-Type Retainer  
Head Dia.: 12mm  
Stem Length: 8mm  
(Not Including The Pin)  
Fits Into 6mm Hole

UNIT PACKAGE: 25



**14726**

(63844-01A99)  
Black Nylon

Push-Type Retainer  
Head Diameter: 17mm  
Stem Length: 18mm  
Fits Into 8mm Hole

UNIT PACKAGE: 25



**20185**

(01553-09601)  
Brown Nylon

Kick Plate  
Push-Type Retainer  
Head Diameter: 18mm  
Stem Length: 20mm  
Fits Into 9mm Hole  
Frontier Truck  
1997 - On

UNIT PACKAGE: 15



**16859**

(Nissan: 66860-01W01;  
GM: 94051993)  
Black Nylon

Cowl Panel To  
Reinforcement Plate &  
Engine Splash Shield Ret.  
Head Dia: 14mm (9/16")  
Stem Length: 16mm (5/8")  
Fits Into 6mm (1/4") Hole  
Nissan 1980-On  
Geo Storm 1990-On

UNIT PACKAGE: 25



**16784**

(Nissan: 80999-05N07;  
Toyota: 90467-07043)  
Black Nylon

Push-Type Retainer  
Head Dia: 18mm  
Stem Length: 11mm  
(Not Including The Pin)  
Fits Into 7mm Hole

UNIT PACKAGE: 25



**20613**

(63848-40Y00)  
Black Nylon

Front Bumper  
Push-Type Retainer  
Head Diameter: 18mm  
Stem Length: 20mm  
Fits Into 9mm Hole  
Frontier & Xterra  
1998 - On

UNIT PACKAGE: 15



**14696**

(Nissan: 10998-30880;  
Honda: 90684-SA5-0030;  
Isuzu: 8942981190)  
Black Nylon

Push-Type Retainer  
Head Dia: 15mm  
Stem Length: 11mm  
Fits Into 6mm Hole

UNIT PACKAGE: 25



**20349**

(01553-09611)  
Black Nylon

Bumper Clip  
Push-Type Retainer  
Head Diameter: 18mm  
Stem Length: 12mm  
Fits Into 8mm Hole  
Maxima  
1994 - On

UNIT PACKAGE: 15



**20327**

(63848-9E001)  
Black Nylon

Bumper Fascia  
Push-Type Retainer  
Head Diameter: 18mm  
Stem Length: 22mm  
Fits Into 9mm Hole  
Altima  
1997 - On

UNIT PACKAGE: 10



**18265**

(76882-57A00)  
Black Nylon

Body Side Moulding  
Push-Type Retainer  
Head Diameter: 16mm  
Stem Length: 20mm  
Fits Into 8mm Hole  
Sentra 1986-On

UNIT PACKAGE: 25



**19246**

(01553-09241)  
Black Nylon

Bumper  
Push-Type Retainer  
Head Diameter: 18mm  
Stem Length: 15mm  
Fits Into 10mm Hole  
240SX & Maxima  
1994-On

UNIT PACKAGE: 15



**16782**

(Honda:  
91545-SE0-0030-W;  
Nissan:  
63848-01G00)  
Black Nylon

Push-Type Retainer  
Head Dia: 20mm  
Stem Length: 14mm  
Fits Into 8mm Hole

UNIT PACKAGE: 25





**16858**

(Nissan: 63844-01A00;  
Kia: MNA01-56-145;  
Mazda: NA01-56-145;  
Ford: MNA01-56145,  
NA01-56145)  
Black Nylon

Inner Fender Push-Type Retainer  
Head Dia: 20mm (25/32")  
Stem Length: 18mm (23/32")  
Fits Into 8mm (5/16") Hole  
Nissan 1980-On  
Mazda, Kia & Ford

UNIT PACKAGE: 25



**19274**

(01553-09321)  
Black Nylon

Push-Type Retainer  
Head Diameter: 20mm  
Stem Length: 9mm  
(Not Including The Pin)  
Fits Into 8mm Hole  
Maxima & 300ZX 1994-On

UNIT PACKAGE: 15



**20753**

(01553-03201)  
Black Nylon

Front & Rear Bumper  
Push-Type Retainer  
Head Diameter: 22mm  
Stem Length: 21mm  
Fits Into 8mm Hole  
Nissan  
1982 - On

UNIT PACKAGE: 10



**16000**

(Honda:  
90675-SB3-003;  
Mazda: FB01-56-964;  
Nissan: 63876-95596)  
Black Nylon

Push-Type Retainer  
Head Dia: 20mm  
Stem Length: 9mm  
Fits Into 8mm Hole

UNIT PACKAGE: 25



**20953**

(11296-AG000)  
Black Nylon

Front Bumper And  
Radiator Support  
Push-Type Retainer  
Head Diameter: 20mm  
Stem Length: 13mm  
Fits Into 8mm Hole  
Infiniti FX 35/45 and  
Nissan Altima, Maxima  
& Quest  
2002 - On

UNIT PACKAGE: 25



**17347**

(01553-06721)  
Black Nylon

Front & Rear Bumper  
Cover Push-Type Retainer  
Head Diameter: 20mm  
Stem Length: 15mm  
Fits Into 8mm Hole  
Maxima & Infiniti  
1990-On

UNIT PACKAGE: 15



**20348**

(63878-01E10)  
Black Nylon

Push-Type Retainer  
Head Diameter: 20mm  
Stem Length: 22mm  
Fits Into 8mm Hole  
Maxima 1994 - On

UNIT PACKAGE: 15



**17472**

(Mitsubishi: MB547806;  
Nissan: 63854-01A00)  
Black Nylon

Front Bumper Fascia  
Push-Type Retainer  
Head Diameter: 20mm  
Stem Length: 20mm  
Fits Into 8mm Hole  
300ZX 1990-On

UNIT PACKAGE: 15



**16725**

(66814-01G00)  
Black Nylon

Cowl Grille Retainer  
Head Size: 8mm x 12mm  
Stem Length: 8mm  
Fits Into 6mm Square Hole  
Nissan Pick-Up 1986-On

UNIT PACKAGE: 25



**19905**

(01553-10051)  
Black Nylon

Push-Type Retainer  
Head Diameter: 20mm  
Stem Length: 8mm  
Fits Into 8mm Hole  
Maxima 1999 - On

UNIT PACKAGE: 15



**17378**

(01553-03101)  
Black Nylon

Bumper & Fascia  
Push-Type Retainer  
Head Diameter: 22mm  
Stem Length: 14mm  
Fits Into 11mm Hole  
Nissan 1986-On

UNIT PACKAGE: 15

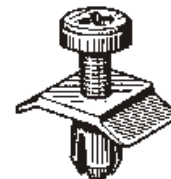

**14725**

(66824-W1000)  
Black Nylon

Push-Type Retainer  
Head Width: 12mm  
Head Length: 18mm  
Stem Length: 10mm  
Fits Into 6mm Hole

UNIT PACKAGE: 15



**14727**

(Nissan: 63844-D0100;  
Isuzu: 8942211500)  
Black Nylon

Push-Type Retainer  
5mm x 14mm Screw  
Head Size: 14mm x 22mm  
Stem Length: 9mm  
Fits Into 7mm Hole

UNIT PACKAGE: 25

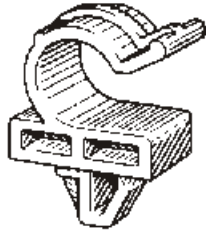

**16780**

(Nissan:  
99604-H1400;  
Toyota:  
58788-13010)

Hood Prop Rod Clip  
Holds 11mm Dia. Rod  
Fits Into 10mm x 12mm Hole

UNIT PACKAGE: 10



**16340**

(54229-0201P)  
Cadmium & Yellow

Window Crank Handle  
Retaining Clip

UNIT PACKAGE: 100



**14337**

(84653-N7400)  
Nylon

Tube/Cable Routing Clip  
Holds 5mm Tube or Cable  
Snaps Into 5mm Hole

UNIT PACKAGE: 25



**19147**

(62228-51S00)

Front Bumper Retainer  
300ZX  
1992-On

UNIT PACKAGE: 10



**16843**

(Mazda: BF82-50-233;  
Nissan: 01553-01393)  
Black Nylon

Bumper Cover Retainer  
Head Size: 20mm x 30mm  
Stem Length: 18mm  
Fits Into 10mm Hole

UNIT PACKAGE: 10



**14345**

(24220-89986)  
Nylon

Hood Prop  
Rod Clip  
Holds 10mm Rod  
Snaps Into 8mm Hole

UNIT PACKAGE: 10



**21017**

(76882-0M000)  
White

Nylon "U" Nut  
M4.8 (#10) Screw Size  
Panel Range: Up To 1.5mm  
Center Of Hole To Edge: 8mm  
Nissan & Infiniti  
1995 - On

UNIT PACKAGE: 15

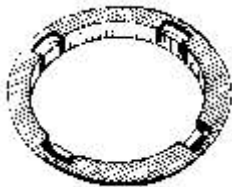

**14346**

(24274-M3000)  
Nylon

Trim Ring  
O.D.: 46mm  
I.D.: 36mm  
Fits Into 40mm Hole

UNIT PACKAGE: 25



**20380**

Not Supplied By O.E.M.  
Black Nylon

Cable Strap  
Length: 200mm (8")  
5mm (3/16") Wide  
Max. Bundle Dia: 44mm (1-3/4")  
Fits Into 6.3mm (1/4") Hole  
Import Cars

UNIT PACKAGE: 25



**17385**

(63848-D4000)  
Black Nylon

Nylon "U" Nut  
Fender/Wheel Housing Applications  
#12 Screw Size  
31mm Wide; 22mm Long  
Panel Range: Up To 2mm  
Center Of Hole To Edge: 9mm  
Sentra

UNIT PACKAGE: 10

NISSAN (Cont.)

OPEL

OPEL (Cont.)

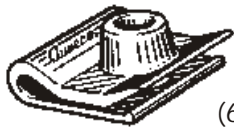

**17193**  
(63848-D0100)  
Nylon

Nylon "U" Nut  
Fender/Wheel Housing  
#12 Screw Size  
20mm Wide, 20mm Long  
Panel Range: Up to 1mm  
Center Of Hole To Edge: 9mm

UNIT PACKAGE: 15



**19735**  
(63848-35F00)  
Black Nylon

Fender Clip "U" Nut  
#10 Screw Size  
20mm Wide  
32mm Long  
Panel Range: Up To 2mm  
Center Of Hole To Edge: 8mm  
Maxima & 240SX  
1994 - On

UNIT PACKAGE: 15



**13225**  
Plated

"U" Type Nut  
4.2mm (#8) Screw Size  
11mm Wide  
16.5mm Long  
Panel Range: .5mm-2.5mm  
Center Of Hole To Edge: 8mm

UNIT PACKAGE: 50

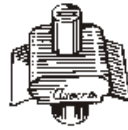

**12642**  
(1-74-713)  
Nylon

Moulding Clip  
UNIT PACKAGE: 10



**13207**  
(Opel 1-76-651;  
Renault 08-54-699-800)  
Nylon w/Metal Washer

Body Retainer  
UNIT PACKAGE: 50



**19153**  
(1-74-820, 03467-531)  
Nylon

Moulding Clip  
UNIT PACKAGE: 25



**13216**  
Zinc

"U" Type Nut  
4.8mm Screw Size  
Panel Range: .9mm-2.0mm  
Center of Hole To Edge: 8mm

UNIT PACKAGE: 25



**13220**  
(Mercedes:  
000-994-09-45;  
Volvo: 946-418;  
Opel: 20-72-175)  
Plated

"U" Type Nut  
6.3mm Screw Size  
Panel Range: .7mm-1.5mm  
Center of Hole To Edge: 13mm

UNIT PACKAGE: 50



**13219**  
(VW: 311-821-161;  
Opel: 20-72-151)  
Plated

"J" Type Nut  
6.5mm Screw Size  
Panel Range: .7mm-1.5mm  
Center of Hole to Edge: 13mm

UNIT PACKAGE: 50

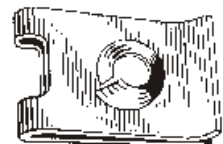

**13222**  
(Mercedes:  
000-994-50-45;  
BMW: 0712-9-925-730;  
VW: N15.457.1; Opel: 20-72-175)  
Plated

"U" Type Nut  
6.5mm Screw Size  
Panel Range: .7mm-1.5mm  
Center of Hole To Edge: 13mm

UNIT PACKAGE: 50

**RENAULT**



**13207**

(Opel: 1-76-651;  
Renault: 08-54-699-800)  
Nylon w/Metal Washer

Body Retainer

UNIT PACKAGE: 50



**9377**

(Renault: 8934-201-263;  
Chrysler: 6000943)  
White Nylon

Radiator Grille Nut  
#8 Screw Size

UNIT PACKAGE: 100



**11855**

(Renault: 8934-201-262;  
GM: 9669486)  
Natural Nylon

#8 Screw Size  
Rear License Plate Bracket Nut  
AMC-Renault  
Side Marker Nut  
GM 1980-On

UNIT PACKAGE: 25



**12713**

(GM: 10032838;  
1264963;  
Chrysler: 6031869;  
Renault: 8934-201-602)  
Natural Nylon

High Torque  
Screw Grommet

UNIT PACKAGE: 25



**13464**

(8934-201-235)  
Natural Nylon

Grille Retainer  
Screw Grommet  
4.2mm #8 Screw Size

UNIT PACKAGE: 25



**13966**

(8934-201-767)  
Black Nylon

Tubular Barrel Nut  
For 3/16" Stud  
Barrel Length 17/64"  
Head Dia. 5/16"  
Head Thick 1/32"  
For Hole Dia. 17/64"

UNIT PACKAGE: 100



**12993**

(7703-077-066)  
Black Nylon

Rear Window Moulding Retainer  
Alliance, 1983-On

UNIT PACKAGE: 25



**13475**

(VW: 175-867-299;  
Renault:  
8934-201-681)  
White Nylon

Trim Panel Retainer  
Head Dia: 19mm  
Stem Length: 18mm  
Stem Dia: 9mm  
AMC Renault 1984-On  
VW 1982-On

UNIT PACKAGE: 50



**13216**

Zinc

"U" Type Nut  
4.8mm Screw Size  
Panel Range: .9mm-2mm  
Center of Hole  
To Edge: 8mm

UNIT PACKAGE: 25

**SUBARU**



**19799**

(91017AA010)  
Black Nylon

Grille Clip  
Legacy Outback  
1996 - On

UNIT PACKAGE: 10

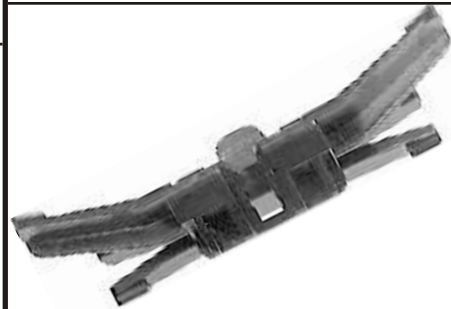

**20370**

(91017-FA010)  
Black Nylon

Windshield Moulding Clip  
Height 15mm,  
Width: 58mm  
Forester & Impreza  
1993 - On

UNIT PACKAGE: 10

FasTrack  
Auveco's Cost  
Recovery System For  
Repair Fasteners.....

Never Lose Money On  
Fasteners Again!

**SUZUKI**



**20743**

(77553-65D00)  
White Nylon

Moulding Clip  
Head Diameter: 18mm  
Stem Length: 9mm  
Overall Length: 18mm  
Suzuki

UNIT PACKAGE: 10



**20744**

(77259-71B00)  
White Nylon

Moulding Clip  
With Sealer  
Top Head Diameter: 13mm  
Bottom Head Diameter: 16mm  
Stem Length: 13mm  
Suzuki

UNIT PACKAGE: 10

**TOYOTA**



**16691**

Natural Nylon

Headlight Adjusting  
Screw Nut

Pick-Up Truck  
1984-On

UNIT PACKAGE: 25



**18747**

(90189-06162)  
Natural Nylon

Front Clearance Lamp Nut  
Camry 1994-91  
Headlight Adjusting Nut  
Lexus

UNIT PACKAGE: 10

**TOYOTA (Cont.)**



**16558**

(81121-14670)

Headlight Adjusting Spring

UNIT PACKAGE: 5



**16951**

(81124-89101)  
Nylon

Headlight Spacer  
15mm Wide x 18mm Long  
Fits Into 7mm Square Hole  
Pick-Up Truck 1984-On

UNIT PACKAGE: 25



**20738**

(53271-44010)  
Black Nylon

Headlight Bracket Clip  
25mm Wide, 40.5mm Long  
Toyota Camry & RAV 4  
And Lexus IS-300  
2001 - On

UNIT PACKAGE: 4



**17194**  
(90467-13005)  
Nylon  
Grille Clip  
13mm Wide  
23mm Long

UNIT PACKAGE: 25



**17438**  
(90467-17004)  
Nylon  
Radiator  
Grille Clip  
Cressida  
1987-84

UNIT PACKAGE: 10



**19430**  
(90904-67021)  
Black Nylon  
Radiator Grille Retainer  
T-100 Truck  
1992-On

UNIT PACKAGE: 15



**15695**  
(Toyota: 62955-20020;  
GM: 94848834)  
Nylon  
Retainer With Sealer  
Head Dia: 15mm  
Stem Length: 9mm  
Fits Into 8mm Hole  
Toyota Pick-Up Truck  
Pontiac Vibe

UNIT PACKAGE: 25



**19671**  
(75398-20050)  
White Nylon  
& Clear Vinyl

Door Moulding Clip  
Sienna Van  
1997 - On

UNIT PACKAGE: 10



**19647**  
(90467-11111)  
Red Nylon

Scuff Plate Retainer  
Head Diameter: 18mm  
Stem Diameter: 10mm  
Stem Length: 10mm  
Sienna  
1997-On

UNIT PACKAGE: 10



**19797**  
(90467-10077)  
Butterscotch Nylon  
Door Moulding Clip  
With Sealer  
Head Diameter: 15mm  
Stem Length: 9mm  
Fits Into 8mm Hole  
Avalon & Corolla  
1998 - On

UNIT PACKAGE: 15



**20687**  
(75495-35010)  
Blue Nylon  
Rocker Moulding Clip  
With Sealer  
Head Diameter: 17mm  
Stem Length: 10mm  
4-Runner  
2003 - On

UNIT PACKAGE: 10



**17481**  
(90467-11063)  
White Nylon  
Rocker Panel  
Moulding Clip  
With Sealer  
Head Dia: 18mm  
Stem Length: 9mm  
Previa  
1990-On

UNIT PACKAGE: 15



**20390**  
(90904-67036)  
Blue Nylon  
Fender Moulding Clip  
Head Diameter: 17mm  
Stem Length: 17mm  
Highlander, Land Cruiser,  
Tacoma & Tundra  
2001 - On

UNIT PACKAGE: 10



**20391**  
(90904-67037)  
Red Nylon  
Fender Moulding Clip  
Head Diameter: 17mm  
Stem Length: 13mm  
Highlander, Land Cruiser,  
Tacoma & Tundra  
2001 - On

UNIT PACKAGE: 10



**20688**  
(75397-35010)  
Orange Nylon  
Wheel Flare Moulding Clip  
With Sealer  
Head Diameter: 17mm  
Stem Length: 17mm  
4-Runner  
2003 - On

UNIT PACKAGE: 10



**20429**  
(90467-11100)  
Yellow Nylon

Fender & Wheel Flare  
Moulding Clip  
Head Dia: 17mm  
Stem Length: 17mm  
Highlander, Land Cruiser,  
Tacoma & Tundra  
2000 - On

UNIT PACKAGE: 10



**19843**  
(75498-42010)  
White Nylon

Garnish Clip  
Head Diameter: 20mm  
Stem Length: 20mm  
RAV 4  
1996 - On

UNIT PACKAGE: 10



**20578**  
(GM: 88970495, 88973654;  
Toyota: 76924-52021)  
Black Nylon

Rocker Moulding Retainer  
Head Diameter: 32mm  
Stem Length: 10mm  
Fits Into 22mm Hole  
Pontiac Vibe & Toyota Corolla  
2003 - On

UNIT PACKAGE: 25



**14264**  
(75395-14020-A)  
Nylon

Moulding Clip  
28mm Wide, 14mm Long  
Snaps Into 7mm Hole

UNIT PACKAGE: 25



**21008**  
(75791-33020)  
Black Nylon

Front & Rear Belt Moulding Clip  
Width: 14mm  
Overall Height: 10mm  
Camry  
2000 - 1997

UNIT PACKAGE: 15



**21071**  
(90084-46020)  
White Nylon

Bumper Cover Clip  
Head Size: 21mm x 30mm  
Stem Length: 12mm  
Camry  
2005 - On

UNIT PACKAGE: 10



**19531**  
(68211-06020)  
Natural Nylon

Door Belt Moulding Clip  
Solara  
1998-On

UNIT PACKAGE: 25



**19380**  
(68211-07010)  
Natural Nylon

Door Belt Moulding Clip  
Avalon  
1994-On

UNIT PACKAGE: 25



**19198**  
(68211-32040)  
Yellow Nylon

Door Belt Moulding  
& Door Weatherstrip Clip  
Camry  
1991-On

UNIT PACKAGE: 50



**21016**  
(75392-35200,  
75392-04010)  
Blue Nylon

Fender Flare &  
Bumper Clip  
Head Size: 13mm x 26mm  
Stem Length: 24mm  
Toyota Camry, FJ,  
RAV 4 & Tacoma  
2005 - On

UNIT PACKAGE: 15

Sec. 22

TOYOTA CLIPS & FASTENERS

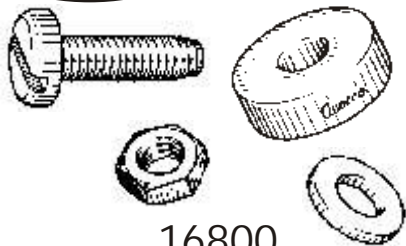

16800

M6-1.0 x 20mm  
License Plate Hardware  
Includes Nylon Screw,  
Washer & Spacer And Brass Nut

UNIT PACKAGE: 25 Sets



17636

Nylon

License Plate  
Bracket Spacer  
1/4" (6mm) I.D.  
3/4" (19mm) O.D.  
1/4" (6mm) Thick

UNIT PACKAGE: 50



19722

(68211-95D00)

White Nylon

Door Glass Clip  
Previa Van  
1990 - On

UNIT PACKAGE: 15

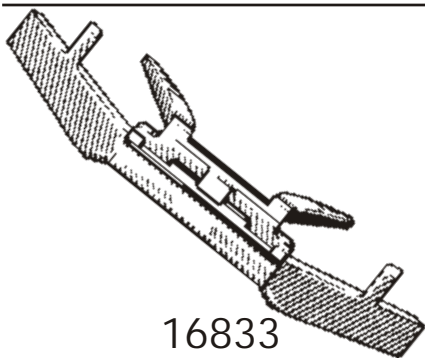

16833

(75545-32020)

Nylon

Windshield Moulding Clip  
12mm Wide, 66mm Long  
Camry 1987-On

UNIT PACKAGE: 10

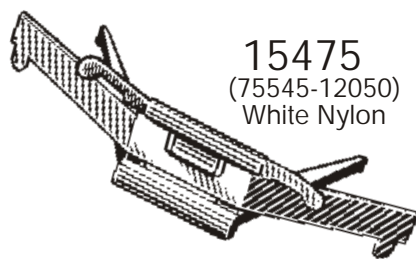

15475

(75545-12050)

White Nylon

Windshield Moulding Clip  
22mm Wide, 56mm Long  
19mm High  
Corolla (RWD) 1984-On

UNIT PACKAGE: 10

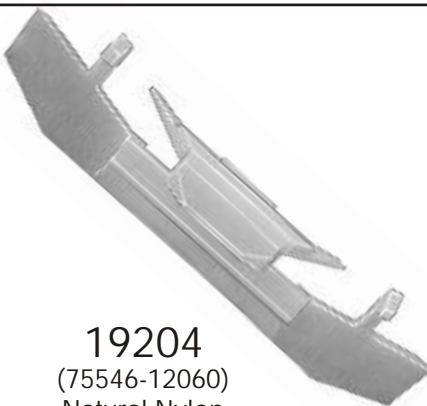

19204

(75546-12060)

Natural Nylon

Windshield Moulding Clip  
Corolla Sedan Wagon  
1992-88

UNIT PACKAGE: 25

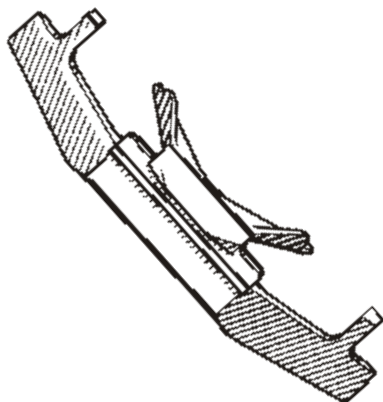

17300

(75545-20060)

Green Nylon

Windshield Moulding Clip  
Celica 1986-On

UNIT PACKAGE: 25

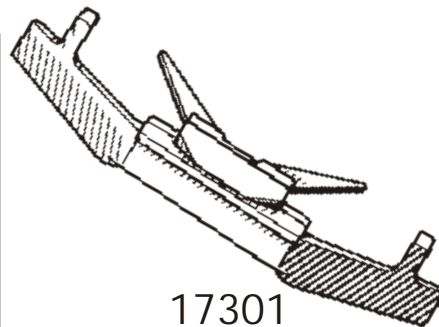

17301

(75546-20060)

Blue Nylon

Windshield Moulding Clip  
Celica 1986-On

UNIT PACKAGE: 25

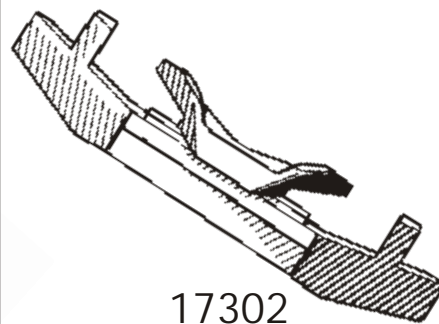

17302

(75545-89103)

Natural Nylon

Windshield Side Moulding Clip  
Without Center Tab  
Truck 1988-On

UNIT PACKAGE: 15

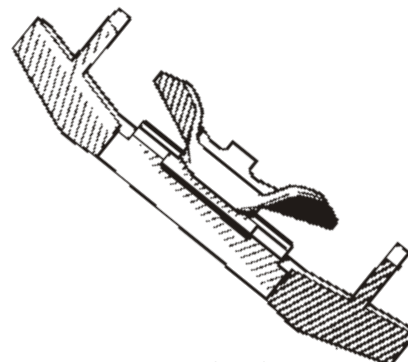

17303

(75545-89102)

Natural Nylon

Windshield Side Moulding Clip  
With Center Tab  
Truck 1988-On

UNIT PACKAGE: 15



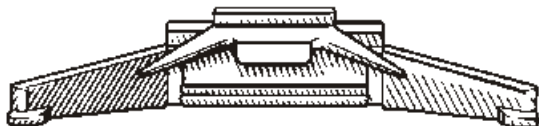

**17334**  
(75546-22060)  
Natural Nylon  
Windshield Side Moulding Clip  
Cressida 1988-On  
UNIT PACKAGE: 15



**17485**  
(75545-32030)  
Natural Nylon  
Windshield Moulding Clip  
Camry 1992-On  
UNIT PACKAGE: 15



**14746**  
(75546-12050)  
Nylon  
Windshield Moulding Clip  
20mm Wide  
41mm Long  
Fits Into 8mm Hole  
UNIT PACKAGE: 15



**12587**  
(75546-12010)  
Nylon  
Windshield Moulding Clip  
20mm Wide; 40mm Long  
Fits Into 8mm Hole  
UNIT PACKAGE: 10



**17298**  
(75547-22010)  
Black Nylon  
Windshield Moulding Clip  
20mm Wide, 47mm Long  
1981-On  
UNIT PACKAGE: 25



**14278**  
(75548-24020)  
Nylon  
Windshield Clip  
With Adhesive Backing  
14.5mm Wide  
60mm Long  
UNIT PACKAGE: 10

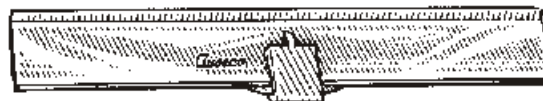

**14731**  
(75548-32010)  
Nylon  
Windshield Clip  
With Adhesive Backing  
14.5mm Wide  
70mm Long  
UNIT PACKAGE: 25

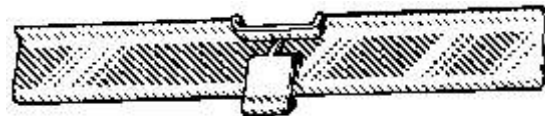

**17330**  
(75548-16010)  
Nylon  
Windshield Moulding Clip  
With Adhesive Backing  
14.5mm Wide, 71mm Long  
Corolla 1988-83  
UNIT PACKAGE: 15



**17332**  
(75548-20060)  
Nylon  
Windshield Moulding Clip  
With Adhesive Backing  
8mm Wide, 40mm Long  
Camry, Celica & Supra  
1989-86  
UNIT PACKAGE: 10

Note: If an adhesion problem occurs with the adhesive backed clips, warm the back with a heat gun.



**19484**  
(75548-22150)  
Blue Nylon

Windshield Moulding Clip  
With Adhesive Backing  
9mm Wide, 40mm Long  
Cressida  
1988-On

UNIT PACKAGE: 10



**14749**  
(75545-88080;  
75545-28010-B)  
Nylon

Windshield Moulding Clip  
18mm Wide  
49mm Long  
16mm High

UNIT PACKAGE: 25



**16942**  
(75545-89101)  
Nylon

Windshield Moulding Clip  
15mm Wide, 47mm Long  
13mm High  
Pick-Up Truck 1984-On

UNIT PACKAGE: 15



**14745**  
(75546-22050)  
Nylon

Windshield Moulding Clip  
14mm Wide  
47mm Long  
12mm High

UNIT PACKAGE: 25



**14747**  
(75545-14081)  
Nylon

Windshield Moulding Clip  
18mm Wide  
50mm Long  
15mm High

UNIT PACKAGE: 25



**17224**  
(90189-04022,  
95900-04036)  
Nylon

#6 Screw Size  
10mm Wide, 10mm Long  
Snaps Into 7mm x 7mm Hole

UNIT PACKAGE: 50

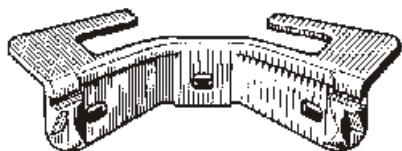

**14751**  
(75545-16020)  
Nylon

Windshield Moulding Clip  
18mm Wide  
49mm Long  
13mm High

UNIT PACKAGE: 25



**16821**  
(75546-12030)  
Nylon

Windshield Moulding Clip  
21mm Wide, 54mm Long  
15mm High  
Corolla 1984-On

UNIT PACKAGE: 25

Do You Want Your  
Customers To Know You  
Use The Best Body  
Hardware & Specialty  
Fasteners Available?  
Promotional Products And  
Apparel Bearing  
  
The Logo Promote Your  
Identity As A Professional.

Note: If an adhesion problem occurs with the adhesive backed clips, warm the back with a heat gun.



**14271**  
(90189-04011)  
Natural Nylon

#6 Screw Size  
12mm Wide, 12mm Long  
Snaps Into 7mm x 7.5mm Hole

UNIT PACKAGE: 25



**14258**  
(90189-06018)  
Black Nylon

#10 Screw Size  
14mm Wide  
14mm Long  
Snaps Into 9mm x 9mm Hole

UNIT PACKAGE: 25



**19840**  
(90189-04176)  
Natural Nylon

Mudguard Screw Grommet  
#8 (M4.2 - 1.41) Screw Size  
Head Size: 10mm x 10mm  
Stem Length: 15mm  
Corolla  
1997 - On

UNIT PACKAGE: 15



**19504**  
(90189-04211)  
White Nylon

Front Door Moulding  
Nylon Nut  
#6 Screw Size  
T100 Truck  
1992-On

UNIT PACKAGE: 20



**20895**  
(90189-06193)  
Natural Nylon

Front Bumper Nylon Nut  
Use With M5.5 (#12) Screw  
Head Size: 14mm x 16mm  
Stem Length: 10mm  
Avalon & Camry  
2002 - On

UNIT PACKAGE: 25



**14740**  
(90189-04063)  
White Nylon

Screw Grommet  
#6 Screw Size  
14mm Wide  
14mm Long  
Stem Length: 10mm  
Fits Into 6mm x 6mm Hole

UNIT PACKAGE: 25



**14256**  
(90189-04014)  
Natural Nylon

#8 Screw Size  
10mm Wide, 10mm Long  
Snaps Into 7mm x 7mm Hole

UNIT PACKAGE: 50



**14739**  
(Toyota: 90189-05012;  
Isuzu: 8941340270)  
Natural Nylon

#6 Screw Size  
16mm Wide  
12mm Long  
Snaps Into 6mm x 10mm Hole

UNIT PACKAGE: 50



**13932**  
(Toyota: 90189-05013;  
Mitsubishi: MS-480002)  
Natural Nylon

#10 Screw Size  
12mm Wide, 12mm Long  
Fits Into 8mm x 9mm Hole

UNIT PACKAGE: 50



**20431**  
(90189-05105)  
Natural Nylon

Front Fender Flare  
Screw Grommet  
Use With M4.2 (#8) Screw  
Head Size: 10mm x 15mm  
Stem Length: 12mm  
RAV 4  
1996 - On

UNIT PACKAGE: 15



**19265**  
(90189-04150)  
White Nylon

Windshield Moulding  
Screw Grommet  
#4 Screw Size  
T100  
1992-On

UNIT PACKAGE: 15



**14274**  
(Toyota: 90189-06010;  
Honda: 75521-611-0000;  
Mazda: 9991-00-601;  
Nissan: 96706-P0105)  
Natural Nylon

#10 Screw Size  
13mm Wide, 13mm Long  
Snaps Into 8.5mm x 8.5mm Hole

UNIT PACKAGE: 25



**20442**  
(90189-04127)  
Natural Nylon

Door Panel Nylon Nut  
M3.5 (#6) Screw Size  
Head Size: 14mm x 14mm  
Stem Length: 15mm  
Toyota Tundra  
1999 - On

UNIT PACKAGE: 25



**19783**  
(Ford: N811169-S,  
W705550-S300  
Toyota: 90075-10801,  
90189-06111)  
White Nylon

Head Diameter: 13mm  
Stem Length: 9mm  
Fits Into 11mm Hole  
Ford, Lexus & Toyota

UNIT PACKAGE: 50



**14277**  
(90189-04008,  
90467-12096)  
Black Nylon

Screw Grommet  
#8 Screw Size  
15mm High  
12mm Wide  
16mm Long  
Fits Into 10mm x 10mm Hole  
UNIT PACKAGE: 15



**19841**  
(55799-12010)  
Blue Nylon

Cowl Screw Grommet  
#10 (M4.8) Screw Size  
Fits Into 10mm x 15mm Hole  
Toyota Celica & Corolla  
1997 - On  
UNIT PACKAGE: 10



**14268**  
(Toyota: 90189-04013;  
Honda:  
90672-671-8110M1)  
Natural Nylon

#6 Screw Size  
Head Diameter: 14mm  
Stem Length: 15mm  
Fits Into 7mm x 7mm Hole  
UNIT PACKAGE: 25



**18843**  
(90189-04031)  
Natural Nylon

Grille & Rear Filler Nut  
#8 Screw Size  
Camry & Rav 4  
2000 - 1991  
UNIT PACKAGE: 25



**21015**  
(52535-50060,  
52535-0E010)  
Black Nylon

Front Bumper  
Screw Grommet  
M5.5 - M6 (#12) Screw Size  
Head Size: 17mm x 30mm  
Stem Length: 9mm  
Lexus IS250, IS350,  
RX330 & RX350 and  
Toyota Camry, Highlander  
& Tacoma  
2001 - On  
UNIT PACKAGE: 5



**14695**  
(Toyota: 90189-06042;  
Honda: 90661-SC7-0030;  
Mazda: H001-50-841;  
Mitsubishi: MS-480012;  
Nissan: 01651-00481,  
74798-S9000)  
White Nylon

Screw Grommet  
#8 Screw Size  
Head Diameter: 16mm  
Stem Length: 17mm  
Fits Into 8mm x 8mm Hole  
UNIT PACKAGE: 25



**17352**  
(81127-01010,  
81132-32121,  
95900-08025)  
Black Nylon

Headlight Nut  
Fits Into 13mm x 16mm Hole  
Toyota 1988-On  
UNIT PACKAGE: 10



**14265**  
(90189-06006)  
Natural Nylon

#10 Screw Size  
Head Diameter: 17mm  
Fits Into 9mm x 9mm Hole  
UNIT PACKAGE: 25



**14275**  
(Toyota: 90189-06001;  
Mitsubishi: MB-098145;  
Nissan: 01281-00023)  
White Nylon

Screw Grommet  
#10 Screw Size  
Head Diameter: 18mm  
Stem Length: 17mm  
Fits into 8.5mm x 8.5mm Hole  
UNIT PACKAGE: 25



**18846**  
(53145-16020)  
Black Nylon  
Radiator Grille  
Garnish Grommet  
Tercel  
1990-On

UNIT PACKAGE: 10



**19187**  
(90189-05082)  
Natural Nylon

Hood Seal To Cowl Top  
Screw Grommet  
#6 Screw Size  
Head Diameter: 13mm  
Stem Length: 13mm  
Fits Into 7mm x 7mm Hole  
2WD & 4WD Truck  
1988-On  
UNIT PACKAGE: 15



**14281**  
(Honda: 90662-693-0030;  
Toyota: 90189-04066)  
White Nylon

Screw Grommet  
#6 Screw Size  
Head Diameter: 14mm  
Stem Length: 10mm  
Fits Into 7mm x 7mm Hole  
UNIT PACKAGE: 25



**14263**  
(90189-04019)  
Natural Nylon

#8 Screw Size  
12mm Wide, 14mm Long  
Fits Into 6.5mm x 8.5mm Hole  
UNIT PACKAGE: 25



**19505**  
(90189-06029,  
90189-06084,  
90189-06116)  
Natural Nylon

Rear Door Panel  
Screw Grommet  
#12 Screw Size  
Head Diameter: 18mm  
Stem Length: 17mm  
Fits Into 9mm x 9mm Hole  
Camry & Previa  
1988 - On

UNIT PACKAGE: 10



**19756**  
(90189-06214)  
Black Nylon

Fender Liner  
Screw Grommet  
#12 (M5.5) Screw Size  
Head Diameter: 16mm  
Stem Length: 18mm  
Sienna, Tacoma & Tundra Pick-Up  
1999 - On

UNIT PACKAGE: 15



**20412**  
(90189-06114)  
White Nylon

Front Fender Liner  
Screw Grommet  
Use With M5.5 (#12) Screw  
Head Dia: 18mm  
Stem Length: 15mm  
Fits Into 9mm Sq. Hole  
RAV 4  
1996 - On

UNIT PACKAGE: 15



**19742**  
(90189-06104)  
Natural Nylon

Fender Lining  
Screw Grommet  
#12 (M5.5) Screw Size  
Head Diameter: 18mm  
Stem Length: 15mm  
Fits Into a 9mm Square Hole  
Lexus IS300 & Toyota Avalon,  
Camry & Sienna  
1997-On

UNIT PACKAGE: 15



**19721**  
(90189-06157)  
Black Nylon

Fender Lining  
Screw Grommet  
#12 Screw Size  
Head Diameter: 20mm  
Stem Length: 22mm  
Fits Into 8mm x 8mm Hole  
Avalon, Camry, Rav 4, Solara &  
Tacoma  
1995-On

UNIT PACKAGE: 15



**14266**  
(90189-06003)  
Nylon

Screw Grommet  
#14 (1/4") Or  
M6.3-1.81 Screw Size  
Head Diameter: 18mm  
Stem Length: 21mm  
Fits Into 8mm x 8mm Hole

UNIT PACKAGE: 15



**14273**  
(90189-06005)  
White Nylon

Screw Grommet  
#14 (1/4") Or M6.3-1.81 Screw Size  
Head Diameter: 18mm  
Stem Length: 16mm  
Fits Into 8mm x 8mm Hole  
Lexus & Toyota

UNIT PACKAGE: 50



**19194**  
(Toyota: 90189-06028;  
GM: 94854203)  
Black Nylon

Front & Rear Wheel  
Fender Liner Screw Grommet  
#12 Screw Size  
Head Diameter: 16mm  
Stem Length: 19mm  
Fits Into 9mm x 9mm Hole  
Tacoma, T100 & 4 Runner  
1992-On  
Chevrolet Nova & Prizm  
And Pontiac Vibe  
1985-On

UNIT PACKAGE: 15



**20440**  
(90189-06065)  
Black Nylon

Hood & Fender  
Screw Grommet  
M5.5 (#12) Screw Size  
Head Diameter: 20mm  
Stem Length: 18mm  
Fits Into 9mm x 9mm Hole  
Camry & RAV 4  
1999 - 95

UNIT PACKAGE: 15



**14267**  
(90189-06013)  
Black Nylon

Screw Grommet  
#14 (1/4") Or M6.3-1.81 Screw Size  
Head Diameter: 20mm  
Stem Length: 17mm  
Fits Into 8mm x 8mm Hole  
Lexus & Toyota

UNIT PACKAGE: 25



**19727**  
(90467-08184)  
White Nylon

Cowl Grommet  
Head Diameter: 15mm  
Stem Length: 10mm  
Fits Into 8mm Hole  
4 Runner, Pre Runner,  
Tacoma & Tundra  
1995-On

UNIT PACKAGE: 15



**20757**  
(47749-58010)  
Black Nylon

Front Fender & Bumper  
Cover Pin Retainer  
Head Diameter: 15mm  
Stem Length: 25mm  
Use With Auveco 20758  
Lexus and Toyota 4 Runner  
Highlander, Sienna & Solara  
2000 - On

UNIT PACKAGE: 10



**19312**  
(90467-05096-22)  
Black Nylon

Luggage Compartment  
Trim Panel Retainer  
Head Diameter: 16mm  
Stem Diameter: 5mm  
Stem Length: 13mm  
Tercel & Paseo  
1994-On

UNIT PACKAGE: 25



**19534**  
(90467-10152)  
Natural Nylon

Cowl Vent Grommet  
Flange Diameter: 18mm  
Stem Length: 16mm  
Fits Into 9mm Hole  
Use With Auveco 19535  
Lexus ES300, Toyota Camry  
& Tercel  
1995-On

UNIT PACKAGE: 10



**19583**  
(90950-01911)  
Black Nylon

Rocker Panel Retainer  
Diameter: 25mm  
Solara  
1998-On

UNIT PACKAGE: 10



**19643**  
(90467-06175)  
Black Nylon

Luggage Compartment  
Retainer  
Head Diameter: 16mm  
Stem Diameter: 6mm  
Stem Length: 16mm  
Solara  
1998-On

UNIT PACKAGE: 15



**19535**  
(90467-07126)  
Black Nylon

Cowl Vent Pin Retainer  
Head Diameter: 16mm  
Stem Length: 17mm  
Use With Auveco 19534  
Lexus ES300, Toyota Camry  
& Tercel  
1995 - On

UNIT PACKAGE: 10



**19014**  
(90467-10123)  
Natural Nylon

Trim Panel Retainer  
Head Size: 11mm x 12mm  
Stem Length: 16mm  
Fits Into 8mm Hole  
Celica 1993-On

UNIT PACKAGE: 10



**19121**  
(90467-08104)  
Gray Nylon

Roof Headliner Retainer  
Head Diameter: 20mm  
Stem Diameter: 8mm  
Stem Length: 20mm  
MR2  
1990-On

UNIT PACKAGE: 15



**20758**  
(53879-58010)  
Black Nylon

Front Fender & Bumper  
Cover Clip  
Width: 25mm  
Length: 34mm  
Use With Auveco 20757  
Lexus and Toyota 4 Runner,  
Highlander, Sienna & Solara  
2000 - On

UNIT PACKAGE: 5



**19686**  
(90467-05045-22)  
Black Nylon

Weatherstrip Retainer  
Head Diameter: 12mm  
Stem Diameter: 5mm Sq.  
Stem Length: 6mm  
Solara 1998-On

UNIT PACKAGE: 25



**20184**  
(90467-08186)  
Black Nylon

Luggage Compartment  
Trim Retainer  
Head Diameter: 16mm  
Stem Diameter: 8mm  
Stem Length: 16mm  
Camry  
1999 - On

UNIT PACKAGE: 25



**20878**  
(90467-A0008)  
Black Nylon

Bumper Cover Retainer  
Head Diameter: 19mm  
Stem Diameter: 7.5mm  
Stem Length: 16mm  
Toyota, Lexus & Scion  
1995 - On

UNIT PACKAGE: 50



**20438**  
(90467-06070-B1)  
Gray Nylon

Headliner Retainer  
Head Dia.: 25mm  
Stem Dia.: 6mm  
Stem Length: 17mm  
RAV 4  
1995 - On

UNIT PACKAGE: 25



**18297**  
(Toyota: 90467-08004,  
90467-08011; GM:  
94842841, 94849113)  
Black Nylon

Hood Seal Retaining Clip  
Head Diameter: 13mm  
Stem Length: 11mm  
Fits Into 5mm Hole  
Lexus, Toyota, Geo Prizm & Nova  
1985-On

UNIT PACKAGE: 50



**14737**  
(Toyota: 90467-07050;  
Nissan: 01553-00172)  
Black Nylon

Retaining Clip  
Head Diameter: 13mm  
Stem Length: 15mm  
Fits Into 5mm Hole  
Panel Thickness: 3mm

UNIT PACKAGE: 25



**14736**  
(90467-06161-01)  
Black Nylon

Retaining Clip  
Head Diameter: 14mm  
Stem Length: 10mm  
Fits Into 5mm Hole  
Panel Thickness: 3mm

UNIT PACKAGE: 25



**16781**  
(Honda: 90670-692-0030;  
Toyota: 90467-09065)  
Black Nylon

Retaining Clip  
Head Dia: 15mm  
Stem Length: 20mm  
Panel Thickness: 11mm  
Fits Into 7mm Hole

UNIT PACKAGE: 25



**19122**  
(90467-08122)  
Natural Nylon

Headliner Retaining Clip  
Head Diameter: 15mm  
Stem Diameter: 8mm  
Stem Length: 12mm  
Tacoma & T100  
1992-On

UNIT PACKAGE: 15



**19124**  
(90467-07096)  
Black Nylon

Side Trim Panel  
Retaining Clip  
Head Diameter: 16mm  
Stem Length: 10mm  
Fits Into 6mm Hole  
4WD Truck 1989-On

UNIT PACKAGE: 10



**16777**  
(Mazda: B001-68-302-00;  
Toyota: 90950-01248)  
Black Nylon

Retaining Clip  
Head Dia: 15mm  
Stem Length: 15mm  
Panel Thickness: 2mm  
Fits Into 8mm Hole

UNIT PACKAGE: 25



**16779**  
(Honda:  
74842-659-0030; Toyota:  
90467-12078)  
Black Nylon

Retaining Clip  
Head Dia: 18mm  
Stem Length: 15mm  
Panel Thickness: 6mm  
Fits Into 8mm Hole

UNIT PACKAGE: 25



**19842**  
(75867-30110)  
Black Nylon

Rocker Panel Clip  
Head Diameter: 18mm  
Stem Length: 22mm  
Fits Into 9mm Hole  
Corolla  
1997 - On

UNIT PACKAGE: 15



**19113**  
(90467-08124)  
Black Nylon

Hood Insulation Retainer  
Head Diameter: 25mm  
Stem Diameter: 8mm  
Stem Length: 12mm  
Supra 1993-On  
Lexus 1994-89

UNIT PACKAGE: 15



**19729**  
(90467-09050)  
Black Nylon

Hood Insulation Retainer  
Head Diameter: 25mm  
Stem Length: 10mm  
Fits Into 7mm Hole  
Lexus, Camry & Solara  
1998-On

UNIT PACKAGE: 15



**14738**  
(90467-09008)  
Black Nylon

Retaining Clip  
Head Diameter: 30mm  
Stem Length: 17mm  
Fits Into 7mm Hole  
Panel Thickness: 6mm  
UNIT PACKAGE: 25



**20443**  
(67867-0C010)  
Black Nylon

Weatherstrip Retainer  
Head Size: 5mm x 15mm  
Stem Length: 10mm  
Fits Into 6mm Hole  
Tundra  
1999 - On

UNIT PACKAGE: 25



**18878**  
(90467-08081)  
Black Nylon

Hood Insulation Retainer  
Head Diameter: 30mm  
Stem Length: 16mm  
Fits Into 6mm Hole  
Celica 1993-89

UNIT PACKAGE: 15



**19123**  
(90467-10107)  
Black Nylon

Fender Apron Seal Clip  
Head Diameter: 17mm  
2WD & 4WD Truck  
1988-On

UNIT PACKAGE: 10



**19728**  
(90467-10146)  
Black Nylon

Cowl Panel Retainer  
Head Size: 8mm x 17mm  
Stem Length: 14mm  
Fits Into 7mm Hole  
Sienna Van  
1997 - On

UNIT PACKAGE: 25



**19112**  
(90467-09004)  
Black Nylon

Hood Insulation Retainer  
Head Diameter: 30mm  
Stem Diameter: 8mm  
Stem Length: 16mm  
Tacoma 1995-On

UNIT PACKAGE: 15



**19749**  
(67867-12150)  
White Nylon

Weatherstrip Retainer  
Head Size: 5mm x 15mm  
Stem Length: 10mm  
Fits Into 6mm Hole  
Avalon  
1995 - On

UNIT PACKAGE: 15



**19720**  
(90467-06138)  
Black & White Nylon

Hood To Cowl Seal Retainer  
Head Size: 8mm x 17mm  
Stem Length: 16mm  
Fits Into 7mm Hole  
Avalon & Camry  
1994 - On

UNIT PACKAGE: 10



**18842**  
(90467-09006)  
Black Nylon

Hood Insulation Retainer  
Head Diameter: 30mm  
Stem Length: 17mm  
Fits Into 7mm Hole  
Avalon, Camry, Lexus  
1988-On

UNIT PACKAGE: 15



**18692**  
(Mazda: G031-58-762;  
Toyota: 67868-89101,  
67867-28030,  
67867-89103; Ford:  
E7GZ-6120586-B)  
Natural Nylon

Weatherstrip Retainer  
Head Size: 5mm x 15mm  
Stem Length: 10mm  
Fits Into 5mm Hole  
4-Runner  
1989-83

Mazda 1996-On  
Ford

UNIT PACKAGE: 50



**16778**  
(Mazda: 9927-40-822;  
Toyota: 62581-14020)  
Natural Nylon

Trim Panel Retainer  
Top Head Dia: 14mm  
Bottom Head Dia: 18.5mm  
Stem Dia: 11.5mm  
Stem Length: 14mm  
Overall Length: 20mm

UNIT PACKAGE: 25





**20576**

(GM: 88969790;  
Toyota: 75867-21010)  
Yellow Nylon

Fender Flare Retainer  
Top Head Size: 10mm x 13mm  
Bottom Head Size: 14mm x 18mm  
Stem Diameter: 8.5mm x 8.5mm  
Stem Length: 9mm  
Overall Length: 13.5mm  
Pontiac Vibe &  
Toyota Echo  
2002 - On

UNIT PACKAGE: 25



**18861**

(90467-10162)  
White Nylon

Scuff Plate Retainer  
Top Head Dia: 13mm  
Bottom Head Dia: 18mm  
Stem Dia: 8.5mm x 8.5mm  
Stem Length: 12mm  
Overall Length: 17mm  
Celica  
1993-On

UNIT PACKAGE: 15



**19719**

(67921-32010)  
White Nylon

Scuff Plate Retainer  
Top Head Diameter: 13mm  
Bottom Head Diameter: 18mm  
Stem Dia: 10mm  
Stem Length: 11mm  
Overall Length: 17.5mm  
Avalon, Camry & Corolla  
1997 - On

UNIT PACKAGE: 15



**21012**

(75867-AA010)  
Black Nylon

Rocker Panel &  
Scuff Plate Retainer  
Top Head Diameter: 13mm  
Bottom Head Diameter: 18mm  
Stem Diameter: 9.5mm  
Stem Length: 14mm  
Lexus ES300 & ES330  
2002 - On  
Toyota Avalon, Camry,  
Scion & Solara  
2004 - On

UNIT PACKAGE: 15



**20558**

(62217-13010)  
White Nylon

Garnish Moulding Retainer  
Top Head Diameter: 13mm  
Middle Head Diameter: 16mm  
Bottom Head Diameter: 15mm  
Stem Diameter: 9mm x 9mm  
Stem Length: 11mm  
Overall Length: 17mm  
Lexus and Toyota Corolla,  
Matrix & 4 Runner  
2003 - On

UNIT PACKAGE: 25



**18875**

(67771-16170)  
White Nylon

Door Trim  
Panel Retainer  
Top Head Dia: 13mm  
Bottom Head Dia: 18mm  
Stem Dia: 11mm  
Stem Length: 15mm  
Overall Length: 19.5mm  
Terrel 1991-On

UNIT PACKAGE: 25



**19109**

(67771-30070)  
Natural Nylon

Door Trim Panel  
& Garnish Retainer  
Top Head Dia: 13mm  
Middle Head Dia: 16mm  
Bottom Head Dia: 15mm  
Stem Diameter: 9.5mm  
Stem Length: 11mm  
Overall Length: 18mm  
Corolla Wagon, Terrel,  
T-100 & Tacoma 2WD  
1992-On

UNIT PACKAGE: 25



**20473**

(67771-12070)  
White Nylon

Door Panel &  
Rocker Moulding Retainer  
With Sealer  
Top Head Diameter: 13mm  
Bottom Head Diameter: 18mm  
Stem Diameter: 11mm  
Stem Length: 14mm  
Overall Length: 20mm  
Lexus SC300/400  
Toyota Avalon & Corolla  
1992 - On

UNIT PACKAGE: 15



**20559**

(GM: 88970345;  
Toyota: 90467-10167)  
Blue Nylon

Garnish Moulding Retainer  
Top Head Diameter: 13mm  
Middle Head Diameter: 16mm  
Bottom Head Diameter: 18mm  
Stem Diameter: 9mm x 9mm  
Stem Length: 11mm  
Overall Length: 18mm  
Pontiac Vibe, Lexus and Toyota  
2000 - On

UNIT PACKAGE: 25



**19203**

(67771-89104)  
Natural Nylon

Quarter Board  
Inside Trim Panel Retainer  
Top Head Dia: 13mm  
Middle Head Dia: 16mm  
Bottom Head Dia: 18mm  
Stem Diameter: 11mm  
Stem Length: 11mm  
Overall Length: 18.5mm  
Truck 2WD  
1997-91

UNIT PACKAGE: 15



**18844**

(67771-06010,  
67771-32090)  
White Nylon

Trim Panel Retainer  
Top Head Diameter: 13mm  
Middle Head Diameter: 16mm  
Bottom Head Diameter: 18mm  
Stem Diameter: 10mm  
Stem Length: 13mm  
Overall Length: 20mm  
Cowl Side & Garnish  
Center Pillar Retainer  
Camry  
1991-On

UNIT PACKAGE: 10



**18876**

(Toyota: 90467-10161;  
GM: 94858299)  
White Nylon

Trim Board Retainer  
Top Head Dia: 13mm  
Middle Head Dia: 16mm  
Bottom Head Dia: 18mm  
Stem Dia: 9mm x 9mm  
Stem Length: 14mm  
Overall Length: 20mm  
Toyota Sienna, Solara & Tercel  
1990-On  
Geo Prizm & Pontiac Vibe  
1998-On

UNIT PACKAGE: 25



**14728**

(67771-22020)

Natural & Yellow Nylon

Door Panel Retainer  
Top Head Diameter: 12.5mm  
Middle Head Diameter: 16mm  
Bottom Head Diameter: 13mm  
Stem Diameter: 8.5mm  
Stem Length: 11mm  
Overall Length: 20mm

UNIT PACKAGE: 25



**18950**

(90467-10168)  
Black & White Nylon

Garnish Retainer  
Top Head Dia: 13mm  
Middle Head Dia: 16mm  
Bottom Head Dia: 18mm  
Stem Diameter: 10mm  
Stem Length: 13mm  
Overall Length: 20mm  
Avalon & Camry 1991-On

UNIT PACKAGE: 5



**19910**

(90467-08179)  
Yellow Nylon

Garnish Retainer  
Top Head Diameter: 13mm  
Middle Head Diameter: 16mm  
Bottom Head Diameter: 18mm  
Stem Diameter: 9mm x 9mm  
Stem Length: 14mm  
Overall Length: 20mm  
Tundra  
1999 - On

UNIT PACKAGE: 25



**19015**

(90080-46199)

Natural Nylon

Trim Panel Retainer  
Top Head Dia: 13mm  
Middle Head Dia: 16mm  
Bottom Head Dia: 18mm  
Stem Diameter: 10mm  
Stem Length: 12mm  
Overall Length: 20mm  
Tacoma 1995-On

UNIT PACKAGE: 25



**20575**

(Toyota: 67771-12080;  
GM: 88970656)  
Yellow & White Nylon

Door Panel & Rocker  
Moulding Retainer  
Top Head Dia: 13mm  
Middle Head Dia: 16mm  
Bottom Head Dia: 18mm  
Stem Diameter: 10mm  
Stem Length: 13mm  
Overall Length: 20mm  
Toyota & Lexus  
1998 - On  
Pontiac Vibe 2003 - On

UNIT PACKAGE: 15



**20437**

(90467-09206)  
White Nylon

Trim Panel Retainer  
Top Head Dia: 13mm  
Middle Head Dia: 16mm  
Bottom Head Dia: 18mm  
Stem Dia: 8.5mm x 8.5mm  
Stem Length: 15mm  
Overall Length: 20mm  
RAV 4 & Tundra  
2000 - On

UNIT PACKAGE: 15



**20633**  
(90467-10188)  
Turquoise Nylon

Trim Panel Retainer  
Top Head Diameter: 13mm  
Middle Head Diameter: 16mm  
Bottom Head Diameter: 18mm  
Stem Diameter: 8.5mm x 9mm  
Stem Length: 14mm  
Overall Length: 20mm  
Sienna  
2004 - On

UNIT PACKAGE: 25



**14144**  
(67771-01010)  
Black Nylon

Trim Panel Retainer  
Top Head Diameter: 13mm  
Middle Head Diameter: 15.5mm  
Bottom Head Diameter: 18mm  
Stem Diameter: 9.5mm  
Stem Length: 14mm  
Overall Length: 20.5mm

UNIT PACKAGE: 25



**15709**  
(67771-02030)  
Natural Nylon

Door Trim Retainer  
Top Head Dia: 13mm  
Middle Head Dia: 16mm  
Bottom Head Dia: 17.5  
Stem Diameter: 9.5mm  
Stem Length: 13mm  
Overall Length: 21mm  
Corolla 1990 - On

UNIT PACKAGE: 50



**21102**  
(90467-A0005)  
White Nylon

Door Trim Panel Retainer  
With Sealer  
Top Head Diameter: 13mm  
Middle Head Diameter: 16mm  
Bottom Head Diameter: 18mm  
Stem Diameter: 8.5mm  
Stem Length: 14mm  
Lexus ES 350, GX470, IS250, IS 350,  
IS F, LS 460 & LS 600HL  
and Toyota Camry, FJ Cruiser,  
Highlander, RAV4 & 4-Runner  
2001 - On

UNIT PACKAGE: 15



**14269**  
(Toyota: 67771-01010,  
67771-12010;  
Isuzu: 8942264920;  
Mazda: 9927-40-825)  
White Nylon

Door Panel Retainer  
Top Head Diameter: 13mm  
Middle Head Diameter: 15.5mm  
Bottom Head Diameter: 18mm  
Stem Diameter: 9.5mm  
Stem Length: 14mm  
Overall Length: 20.5

UNIT PACKAGE: 25



**19898**  
(67771-02030)  
Yellow Nylon

Trim Panel Retainer  
Top Head Dia.: 13mm  
Middle Head Dia.: 16mm  
Bottom Head Dia.: 18mm  
Stem Diameter: 9.5mm  
Stem Length: 13mm  
Overall Length: 21mm  
Corolla  
1990 - On

UNIT PACKAGE: 50



**19257**  
(GM: 30006620;  
Toyota: 67771-12050)  
Maroon Nylon

Front & Rear Door  
Trim Board Retainer  
Top Head Diameter: 13mm  
Middle Head Diameter: 16mm  
Bottom Head Diameter: 18mm  
Stem Diameter: 9.5mm  
Stem Length: 14mm  
Overall Length: 20.5mm  
Chevrolet Geo, Metro & Tracker  
1989 - On  
Lexus and Celica,  
Corolla & Previa  
1990-On

UNIT PACKAGE: 15



**14270**  
(67771-22010)  
Blue & Natural Nylon

Door Panel Retainer  
Top Head Diameter: 13mm  
Middle Head Diameter: 15.5mm  
Bottom Head Diameter: 18mm  
Stem Diameter: 9.5mm  
Stem Length: 14mm  
Overall Length: 20.5mm

UNIT PACKAGE: 25



**15707**  
(67771-03030)  
Gray Nylon

Door Trim Retainer  
Top Head Dia: 13mm  
Middle Head Dia: 16mm  
Bottom Head: 17.5mm  
Stem Length: 14mm  
Stem Diameter: 10mm  
Overall Length: 21mm  
Camry 1988 - On

UNIT PACKAGE: 50



**19108**  
(67771-16080)  
Natural Nylon

Door Trim Panel  
& Back Panel  
Upper Garnish Retainer  
Top Head Dia: 13mm  
Middle Head Dia: 16mm  
Bottom Head Dia: 18mm  
Stem Diameter: 9.5mm  
Stem Length: 14mm  
Overall Length: 21mm  
Truck 1988-On

UNIT PACKAGE: 10



**19210**  
(67771-04040)  
Natural Nylon

Front Door  
Trim Panel Retainer  
Top Head Dia: 13mm  
Middle Head Dia: 16mm  
Bottom Head Dia: 18mm  
Stem Diameter: 10mm  
Stem Length: 14mm  
Overall Length: 22mm  
Tacoma 1995 -On

UNIT PACKAGE: 50



**20196**  
(90467-06133-CO)  
Black Nylon

Rocker Panel  
Push-Type Retainer  
Head Diameter: 14mm  
Stem Length: 8mm  
Fits Into 6mm Hole  
4-Runner  
1998 - On

UNIT PACKAGE: 15



**18874**  
(67771-16120)  
Gray Nylon

Front & Rear Door  
Trim Panel Retainer  
Top Head Dia: 13mm  
Middle Head Dia: 16mm  
Bottom Head Dia: 18mm  
Stem Diameter: 9.5mm  
Stem Length: 15mm  
Overall Length: 21mm  
Tercel 1994 - On

UNIT PACKAGE: 15



**19129**  
(Toyota: 67771-30090;  
GM: 95008221)  
Yellow Nylon

Door Trim Panel & Back Panel  
Lower Garnish Retainer  
Top Head Dia: 13mm  
Middle Head Dia: 16mm  
Bottom Head Dia: 18mm  
Stem Diameter: 9.5mm  
Stem Length: 17mm  
Overall Length: 23mm  
Land Cruiser & 2WD Truck  
1991 - On

UNIT PACKAGE: 15



**21104**  
(90467-07190-B2)  
Black Nylon

Interior Trim  
Push-Type Retainer  
Head Diameter: 14mm  
Stem Length: 14mm  
Fits Into 7mm Hole  
Echo & Scion  
2004 - On

UNIT PACKAGE: 10



**19016**  
(67771-12040)  
Dark Gray Nylon

Door Trim Panel Retainer  
Top Head Dia: 13mm  
Middle Head Dia: 16mm  
Bottom Head Dia: 18mm  
Stem Diameter: 9.5mm  
Stem Length: 15mm  
Overall Length: 21mm  
Cressida  
1992 - 88

UNIT PACKAGE: 15



**21103**  
(90467-05090-B1)  
Black Nylon

Front Bumper Fascia  
Push-Type Retainer  
Head Diameter: 10mm  
Stem Length: 12mm  
Fits Into 5mm Hole  
Corolla, Matrix  
& Scion  
2008 - On

UNIT PACKAGE: 10



**14260**  
(Toyota: 90467-06017;  
Mazda: 9926-50-625;  
GM: 20426301)  
Black Nylon

Push-Type Retainer  
Head Diameter: 15mm  
Stem Length: 12mm  
Fits Into 7mm Hole

UNIT PACKAGE: 15



**17206**  
(90467-09145)  
Black Nylon

Bumper Cover  
Push-Type Retainer  
Head Diameter: 15mm  
Stem Length: 12mm  
Fits Into 9mm Hole  
Camry  
1992-On

UNIT PACKAGE: 15

# TOYOTA CLIPS & FASTENERS

Sec. 22



**21011**  
(90467-07188)  
Black Nylon

Push-Type Retainer  
Head Diameter: 15mm  
Stem Length: 17mm  
Fits Into 7mm Hole  
Camry, Tundra  
& 4-Runner  
2002 - On

UNIT PACKAGE: 15



**19490**  
(90467-06150)  
Black Nylon

Back Garnish Trim Panel  
Push-Type Retainer  
Head Diameter: 18mm  
Stem Length: 8mm  
Fits Into 6mm Hole  
Tacoma  
1995 - On

UNIT PACKAGE: 10



**20577**  
(GM: 88970494, 88973676)  
Toyota: 90467-07168)  
Black Nylon

Rocker Panel & Garnish Moulding  
Push-Type Retainer  
Head Diameter: 20mm  
Stem Length: 8mm  
Fits Into 7mm Hole  
Pontiac Vibe 2003 - On  
Lexus & Toyota  
2000 - On

UNIT PACKAGE: 15



**19552**  
(90467-07146)  
Black Nylon

Cowl Panel & Luggage  
Compartment Retainer  
Head Dia.: 16mm  
Stem Length: 9mm  
Fits Into 7mm Hole  
Avalon, Camry, Celica & Solara  
1993 - On

UNIT PACKAGE: 15



**20931**  
(52161-20010)  
Black Nylon

Bumper Cover & Grille  
Push-Type Retainer  
Head Diameter: 18mm  
Stem Length: 31mm  
Fits Into 9mm Hole  
Toyota  
2000 - On

UNIT PACKAGE: 15



**19128**  
(90467-07044)  
Black Nylon

Quarter Panel  
Wheel Opening Moulding  
Push-Type Retainer  
Head Diameter: 20mm  
Stem Length: 9mm  
Fits Into 7mm Hole  
T-100  
1992-On

UNIT PACKAGE: 10



**20335**  
(53879-60010)  
Black Nylon

Fender Liner  
Push-Type Retainer  
Head Diameter: 18mm  
Stem Length: 7mm  
Fits Into 7mm Hole  
Land Cruiser & RAV 4  
1998 - On

UNIT PACKAGE: 15



**19908**  
(90467-07121)  
Black Nylon

Door Trim Panel  
Push-Type Retainer  
Head Diameter: 20mm  
Stem Length: 8mm  
Fits Into 7mm Hole  
RAV4  
1997 - On

UNIT PACKAGE: 10



**21010**  
(90467-09166)  
Black Nylon

Push-Type Retainer  
Head Diameter: 20mm  
Stem Length: 9mm  
Fits Into 9mm Square Hole  
Camry  
2006 - On

UNIT PACKAGE: 15



**20869**  
(GM: 88970767;  
Toyota: 90467-10183)  
Black Nylon

Front Fender Liner  
Push-Type Retainer  
Head Diameter: 18mm  
Stem Length: 7.5mm  
Fits Into 7mm Hole  
Celica, Corolla,  
Matrix & Solara, Lexus And  
Pontiac Vibe  
1999 - On

UNIT PACKAGE: 10



**19907**  
(90467-07121-B2)  
Gray Nylon

Door Trim Panel  
Push-Type Retainer  
Head Diameter: 20mm  
Stem Length: 8mm  
Fits Into 7mm Hole  
RAV4  
1997 - On

UNIT PACKAGE: 10



**20908**  
(90467-07164)  
Black Nylon

Fender Splash Shield  
Push-Type Retainer  
Head Diameter: 20mm  
Stem Length: 10mm  
Fits Into 7mm Hole  
Camry, Echo,  
MR2 & Sienna  
1997 - On

UNIT PACKAGE: 10



**20955**  
(90467-07201)  
Black Nylon

Engine Under Cover  
Push-Type Retainer  
Head Diameter: 20mm  
Stem Length: 10mm  
Fits Into 7mm Hole  
Lexus ES300/330 and  
Toyota Avalon, Camry & Solara  
2002 - On

UNIT PACKAGE: 10



**19219**  
(90467-09096)  
Black Nylon  
Front Bumper  
Push-Type Retainer  
Head Diameter: 15mm  
Stem Length: 27mm  
Fits Into 9mm Hole  
Lexus LS400 1993-On  
Celica & Supra 1989-On

UNIT PACKAGE: 10



**19416**  
(Toyota: 90467-09139)  
Black Nylon

Bumper Cover &  
Wheel Housing  
Push-Type Retainer  
Head Diameter: 18mm  
Stem Length: 15mm  
Fits Into 9mm Hole  
Honda, Mazda 626 &  
Toyota Corolla  
1992-On

UNIT PACKAGE: 15



**19140**  
(Acura:  
90505-SL0-003;  
GM: 94852368;  
Mitsubishi:  
MB888869; Toyota:  
90467-08155)  
Black Nylon

Push-Type Retainer  
Head Dia: 20mm  
Stem Length: 21mm  
Fits Into 8mm Hole  
Acura, Dodge Avenger, Eagle Talon,  
Geo Prizm, Mitsubishi Eclipse  
& Galant and Toyota  
1993-On

UNIT PACKAGE: 5



**17162**  
(GM: 96057846;  
Toyota: 90467-07041)  
Black Nylon

Push-Type Retainer  
Head Diameter: 15mm  
Stem Length: 13mm  
Fits Into 6.3mm Hole  
Geo Metro & Tracker  
And Toyota  
1989 - On

UNIT PACKAGE: 10



**18888**  
(90467-07166)  
Black Nylon

Front Fender Liner  
Push-Type Retainer  
Head Diameter: 20mm  
Stem Length: 8mm  
Fits Into 7mm Hole  
Tercel 1994-On

UNIT PACKAGE: 15



**16784**  
(Nissan: 80999-05N07;  
Toyota: 90467-07043)  
Black Nylon

Push-Type Retainer  
Head Dia: 18mm  
Stem Length: 11mm  
(Not Including The Pin)  
Fits Into 7mm Hole

UNIT PACKAGE: 25



**18873**  
(52161-16010,  
52161-02020)  
Black Nylon

Rear Bumper Cover  
Push-Type Retainer  
Head Diameter: 18mm  
Stem Length: 28mm  
Fits Into 9mm Hole  
Tercel 1988-On

UNIT PACKAGE: 6



**19739**  
(90467-09127)  
Black Nylon

Bumper Cover  
Push-Type Retainer  
Head Diameter: 20mm  
Stem Length: 26mm  
Fits Into 9mm Hole  
Avalon, Camry,  
Corolla & Solara  
1998 - On

UNIT PACKAGE: 10



**19013**  
(90467-07059-22)  
Black Nylon

Rear Door Trim &  
Luggage Compartment Door  
Push-Type Retainer  
Head Diameter: 15mm  
Stem Length: 10mm  
Fits Into 7mm Hole  
Camry & Celica  
1990-On

UNIT PACKAGE: 15



**19488**  
(67772-16020)  
Black Rubber

Front Door  
Trim Retainer Cap  
Fits Into 9mm Hole  
T100 Truck  
1992 - On

UNIT PACKAGE: 10



**14732**  
(53455-14020)  
Nylon

Hood Prop  
Rod Clip  
Holds 8mm Dia. Rod  
Snaps Into 14mm Hole  
UNIT PACKAGE: 15



**17611**  
(53452-90351)  
Nylon

Hood Prod Rod Clip  
Holds 6mm & 7mm Rods  
Toyota

UNIT PACKAGE: 10



**20470**  
(69293-12040)  
Yellow Nylon

Door Lock Rod Clip  
Rod Size: 5mm  
Left (Driver) Side  
Lexus ES 300 2001 - 97  
Toyota Camry, Celica, Corolla,  
Echo, Highlander, MR2, RAV 4,  
Tundra and 4-Runner  
1994 - On

UNIT PACKAGE: 10



**20441**  
(53455-12060)  
Black Nylon

Hood Prop Rod Clip  
Holds 8mm Dia. Rod  
Fits Into 10mm Square Hole  
RAV 4  
1999 - 95

UNIT PACKAGE: 10



**19529**  
(53455-33010,  
53455-33011)  
Natural Nylon

Hood Prop Rod Clip  
Holds 9mm Rod  
Fits Into 10mm Square Hole  
Camry  
1996 - On

UNIT PACKAGE: 15



**20534**  
(69293-12050)  
Natural Nylon

Door Lock Rod Clip  
Rod Size: 5mm  
Fits Into 8.5mm Hole  
Right (Passenger) Side  
Lexus ES250, 300 & RX300  
and Toyota Tacoma  
1990 - On

UNIT PACKAGE: 10

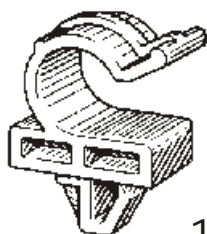

**16780**  
(Nissan: 99604-H1400;  
Toyota: 58788-13010)

Hood Prop Rod Clip  
Holds 11mm Dia. Rod  
Fits Into 10mm x 12mm Hole

UNIT PACKAGE: 10



**20469**  
(69293-12030)  
Natural Nylon

Door Lock Rod Clip  
Rod Size: 5mm  
Right (Passenger) Side  
Lexus ES 300 2001 - 97  
Toyota Camry, Celica, Corolla,  
Echo, Highlander, MR2,  
RAV4, Tundra and 4-Runner  
1994 - On

UNIT PACKAGE: 10



**20535**  
(69293-12060)  
Yellow Nylon

Door Lock Rod Clip  
Rod Size: 5mm  
Fits Into 8.5mm Hole  
Left (Driver) Side  
Lexus ES250, 300 & RX300  
And Toyota Tacoma  
1990 - On

UNIT PACKAGE: 10



**17631**  
(90959-01136)  
Nylon

Hood Prop Rod Clip  
Holds 6mm & 7mm Rods  
Toyota

UNIT PACKAGE: 25

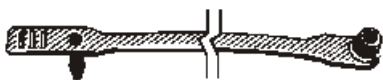

**14284**

(Toyota: 90463-10337;  
Honda: 90669-671-0000;  
90669-671-0030)

Nylon

Cable Strap  
Length: 110mm (5-5/16")  
Max. Bundle Diameter: 23mm  
Fits Into 6mm Hole

UNIT PACKAGE: 15



**16671**

(90468-04030)

Bumper Strip  
Retainer  
Toyota 1984-On

UNIT PACKAGE: 25



**20956**

(90467-05114)

Black Nylon

Bumper & Fender Apron  
Nylon "U" Nut  
Screw Size: M5.5 (#12)  
Width: 20mm, Length: 36mm  
Center Of Hole to Edge: 14mm  
Panel Range: Up To 1mm  
Lexus & Toyota  
2000 - On

UNIT PACKAGE: 10

Not Actual Size



**20380**

Not Supplied By O.E.M.  
Black Nylon

Cable Strap  
Length: 200mm (8")  
5mm (3/16") Wide  
Max. Bundle Dia: 44mm (1-3/4")  
Fits Into 6.3mm (1/4") Hole  
Import Cars

UNIT PACKAGE: 25



**14750**

(Toyota: 53879-14010-A,  
53879-14020,  
53879-22030; GM: 94841226;  
Mazda: LA01-56-135)

Black Nylon

Nylon "U" Nut  
Fender/Wheel  
Housing Applications  
#10 Screw Size  
20mm Wide  
31mm Long  
Panel Range: Up to 1mm  
Center of Hole To Edge: 11mm  
Toyota, Geo Prizm &  
Nova And Mazda

UNIT PACKAGE: 15



**14276**

(53879-22010)

Black Nylon

Nylon "U" Nut  
Fender/Wheel  
Housing Applications  
#14(1/4") Screw Size  
20mm Wide  
29mm Long  
Panel Range: Up To 1mm  
Center Of Hole To Edge: 15mm

UNIT PACKAGE: 15



**16306**

(90183-03001)

Front Bumper  
Cushion Clip  
Toyota 1982-On

UNIT PACKAGE: 25

**19669**  
Same As 14750 Except For Packing

UNIT PACKAGE: 25



**13225**

Plated

"U" Type Nut  
4.2mm (#8) Screw Size  
11mm Wide  
16.5mm Long  
Panel Range: .5mm-2.5mm  
Center of Hole To Edge: 8mm

UNIT PACKAGE: 50



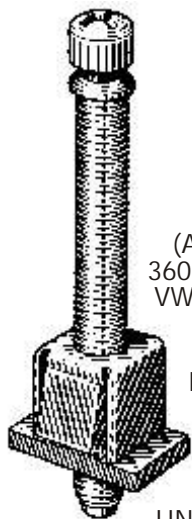

**15666**  
(AMC: 36000148,  
36001966, 56001419;  
VW: 176-941-1117A)

1/4"-28 x 2-1/4"  
Headlight Adjusting  
Screw and  
Nut Assembly  
AMC & VW

UNIT PACKAGE: 10



**19136**

(1HO-853-733B)  
Nylon

Windshield Reveal  
Moulding Clip  
VW Golf & Jetta  
1999-93

UNIT PACKAGE: 15



**10322**

(131-853-585C)  
Nylon

Body Side Moulding Clip  
VW

UNIT PACKAGE: 50



**13175**

(171-853-575A)  
Nylon

Moulding Clip  
VW

UNIT PACKAGE: 50



**13189**

(803-853-139A)  
Nylon

Moulding Clip  
Audi

UNIT PACKAGE: 50



**13174**

(803-853-139C)  
Red Nylon

Moulding Clip  
VW

UNIT PACKAGE: 25



**13229**

(113-853-585C)  
Nylon

Moulding Clip  
w/ Sealer  
VW

UNIT PACKAGE: 50



**12635**

(801-853-577)  
Nylon

Moulding Clip  
VW

UNIT PACKAGE: 25



**20249**

(321-867-299B)  
Natural Nylon

Door Panel Trim Clip  
Eurovan, Golf, Jetta,  
Quantum & Scirocco  
1982 - On

UNIT PACKAGE: 15



**13173**

(VW: N14389.3;  
Volvo: 3104-426)  
Metal

Door Panel Clip  
Use With 13206

UNIT PACKAGE: 50



**13176**

(113-853-585B)  
Metal

Moulding Clip

UNIT PACKAGE: 25



**8843**

Nylon

Moulding Fastener  
Fits 1/2" -5/8" Mouldings

UNIT PACKAGE: 50



**14014**

(VW: 175-853-674;  
GM: 20475950)  
Black Nylon

Air Vent Nut  
Use With 14013 Screw

UNIT PACKAGE: 50



**12735**

(GM: 1370853;  
Chry: 6029501;  
VW: 179-813-883)  
Nylon

Headlight Bezel Nut  
#6 Screw Size  
GM & VW 1982-On

UNIT PACKAGE: 50



**14030**

(GM: 3997391;  
VW: 179-813-881)  
Black Nylon

Tail Light Nut  
#8 Screw Size  
GM Astro & Safari  
1985-On  
Volkswagen

UNIT PACKAGE: 25



**20924**  
(N908-338-01)  
Black Nylon

Fender Apron Screw Grommet  
M4.2 (#8) Screw Size  
Head Dia: 15mm  
Stem Length: 12mm  
Cabrio, Golf, Jetta &  
Phaeton  
1999 - On

UNIT PACKAGE: 15



**13185**  
(803-853-213)  
Nylon

Barrel Nut  
For 2mm Stud  
Fits Into 3mm Hole

UNIT PACKAGE: 50



**20251**  
(701-853-585)  
White Nylon

Retainer  
Top Head Dia: 12mm  
Bottom Head Dia: 18mm  
Stem Dia: 7mm  
Stem Length: 20mm  
Mouldings, Water Deflector  
In Cowl Panel & Floor Coverings  
Eurovan, Golf, Jetta  
& Passat  
1989 - On

UNIT PACKAGE: 25



**20925**  
(N908-214-01)  
Black Nylon

Bumper & Fender Apron  
Screw Grommet  
M4.2 (#8) Screw Size  
Head Dia: 15mm  
Stem Length: 20mm  
Audi A4/S4 and A6/S6  
1996 - On

VW Cabrio, Golf, Jetta & Phaeton  
1999 - On

UNIT PACKAGE: 15



**13227**  
(113-853-615A)  
Nylon

Barrel Nut  
For 3mm Stud  
Fits Into 4mm Hole

UNIT PACKAGE: 50



**13475**  
(Renault:  
8934-201-681;  
VW: 175-867-299)  
White Nylon

Trim Panel Retainer  
Head Dia: 19mm  
Stem Length: 18mm  
Stem Dia: 9mm  
AMC-Renault 1984-On  
VW 1982-On

UNIT PACKAGE: 50



**20250**  
(357-853-586-D)  
Black Nylon

Moulding Insert  
Head Diameter: 13mm  
Stem Length: 6mm  
Fits Into 9mm Hole  
Eurovan, Golf, Jetta  
& Passat  
1989 - On

UNIT PACKAGE: 25



**13179**  
(481-867-197)  
Black Nylon

Trim Panel Retainer  
VW

UNIT PACKAGE: 50



**20933**  
(357-827-998)  
Black Nylon

Front & Rear Door Panel  
Screw Grommet  
M4.8 (#10) Screw Size  
Head Diameter: 16mm  
Stem Length: 20mm  
Cabrio, Golf,  
Jetta & Passat  
1993 - On

UNIT PACKAGE: 15



**13206**  
(113-857-219A)  
Black Vinyl

Door Panel & Trunk Liner Plug  
Use With 13173  
VW Beetle & Audi

UNIT PACKAGE: 50



**20252**  
(823-867-299)  
Black Nylon

Trim Panel Retainer  
Top Head Dia: 14mm  
Bottom Head Dia: 18mm  
Stem Dia: 9mm  
Stem Length: 14mm  
Corrado, Eurovan, Jetta,  
Rabbit & Vanagon  
1979 - On

UNIT PACKAGE: 25



**20260**  
(1J0-853-120)  
Maroon Nylon

Scuff Plate  
Screw Grommet  
Head Size: 14mm x 17mm Oval  
Stem Length: 10mm  
M4.2 (#8) Screw Size  
Golf & Jetta  
1999 - On

UNIT PACKAGE: 15



**13202**  
(801-867-299/041)  
Black Nylon

Retaining Clip  
VW & Audi

UNIT PACKAGE: 25



**20341**  
(3B0-868-243)  
Black Nylon

Door Trim Panel Retainer  
Head Diameter: 22mm  
Stem Length: 10mm  
Fits Into 10mm Hole  
Beetle, Golf, Jetta & Passat  
1998 - On

UNIT PACKAGE: 25



**19195**  
(161-867-299-01C)  
Black Nylon

Push-Type Retainer  
Head Diameter: 16mm  
Stem Length: 12mm  
Fits Into 8mm Hole  
VW Golf & Jetta  
1997-93

UNIT PACKAGE: 25



**13217**  
(N15.422.2)  
Plated

"U" Nut  
4.2mm (#8) Screw Size  
Panel Range: .7mm -1.6mm  
Center Of Hole To Edge: 7mm

UNIT PACKAGE: 25



**13216**  
Zinc

"U" Nut  
4.8mm Screw Size  
Panel Range: .9mm -2mm  
Center Of Hole To Edge: 8mm

UNIT PACKAGE: 25



**13219**  
(Opel: 20-72-151;  
VW: 311-821-161)  
Plated

"J" Nut  
6.5mm Screw Size  
Panel Range: .7mm -1.5mm  
Center Of Hole To Edge: 13mm

UNIT PACKAGE: 50

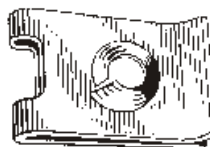

**13222**  
(BMW: 0712-9-925-730;  
Mercedes: 000-994-50-45;  
Opel: 20-72-175;  
VW: N15.457.1)  
Plated

"U" Nut  
6.5mm Screw Size  
Panel Range: .7mm -1.5mm  
Center Of Hole To Edge: 13mm

UNIT PACKAGE: 50



**12595**  
(GM: 11503752, 11505329;  
VW: N90100001)  
Phosphate

Free Spinning Washer Nut  
M6-1.0  
16mm Washer O.D.  
10mm Hex

UNIT PACKAGE: 25

**16268**

Same As 12595 Except For Packing

UNIT PACKAGE: 50



**14013**  
(GM: 20475949;  
VW: 175-853-673)  
Black Nylon

Air Vent Screw  
Use With 14014  
UNIT PACKAGE: 50



**11404**  
(N14-4003)  
Plain Steel

Manifold Stud  
M8-1.25 x 35mm  
UNIT PACKAGE: 25



**11403**  
(N14-443-4)  
Plain Steel

Manifold Stud  
M8-1.25 x 40mm  
UNIT PACKAGE: 25



**11097**  
(N 18 515 1)  
Plated

Grease Fitting  
6mm-1.00, Straight  
DIN 71412  
Ind. Ref. No. 8601  
UNIT PACKAGE: 5



**11098**  
(N 18 516 1)  
Plated

Grease Fitting  
8mm-1.00, Straight  
DIN 71412  
Ind. Ref. No. 8901  
UNIT PACKAGE: 5



**11099**  
(N 18 511 2)  
Plated

Grease Fitting  
8mm-1.00, 90 Degree  
DIN 71412  
Ind. Ref. No. 7490  
UNIT PACKAGE: 5



**11100**  
(N 18 530 1)  
Plated

Grease Fitting  
10mm-1.00, Straight  
DIN 71412  
Ind. Ref. No. 9301  
UNIT PACKAGE: 5



**11101**  
(N 18 510 1)  
Plated

Grease Fitting  
10mm-1.00, 90 Degree  
DIN 71412  
Ind. Ref. No. 9390  
UNIT PACKAGE: 5



**13031**  
(111-837-581J)  
Black Nylon

Window Crank Handle  
VW Beetle  
UNIT PACKAGE: 1



**14194**  
(321-837-581-016)

Window Crank Handle  
VW, Scirocco & Dasher  
1974-On  
UNIT PACKAGE: 1

**VOLVO**

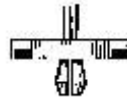

**12637**  
(591-740)  
Nylon

Body Side  
Moulding Clip  
UNIT PACKAGE: 50



**13195**  
(1201-930)  
Black Nylon

Moulding Clip  
UNIT PACKAGE: 10



**20406**  
(1372920-7)  
Black Nylon

Radiator Grille Clip  
9mm Wide, 30mm Long  
850  
1999 - 93  
UNIT PACKAGE: 15



**20405**  
(9151649-2)  
White Nylon

Rocker Panel Moulding Clip  
Stem Length: 14mm,  
Fits Into 8mm Hole  
850, C70, S70 & V70  
1993 - On  
UNIT PACKAGE: 10

**VOLVO (Cont.)**



**13173**  
(VW: N14389.3;  
Volvo: 3104-426)  
Metal

Panel Clip

UNIT PACKAGE: 50

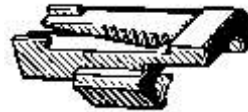

**17314**  
(1342-004)

Windshield Upper & Side  
Moulding Clip  
740 & 760 1985-On

UNIT PACKAGE: 15

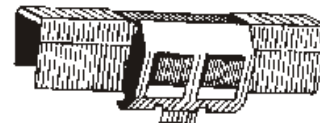

**14211**  
(1-255-551)  
Black Nylon

Windshield Clip

UNIT PACKAGE: 25



**14212**  
(1-246-926)  
Gray Nylon

Windshield Clip

UNIT PACKAGE: 25



**14210**  
(1-255-553)  
White Nylon

Windshield Clip  
UNIT PACKAGE: 15



**14209**  
(1-246-993)  
Green Nylon

Windshield Clip  
UNIT PACKAGE: 15



**13191**  
(680-097)  
Black Nylon

Moulding Retainer  
UNIT PACKAGE: 50



**13230**  
(Mercedes 000-990-03-92;  
Volvo 947-098)  
Black Nylon

Push-Type Retainer  
Head Dia. 10mm  
Stem Length: 7mm  
Fits Into 5mm Hole  
UNIT PACKAGE: 50



**19248**  
(1268176-3)  
Black Nylon

Bumper Cover  
Push-Type Retainer  
Head Diameter: 16mm  
Stem Length: 14mm  
Fits Into 6mm Hole  
740 & 760  
1993-On  
UNIT PACKAGE: 15



**19249**  
(3512624-2)  
Black Nylon

Rocker Panel  
Push-Type Retainer  
Head Diameter: 16mm  
Stem Length: 12mm  
Fits Into 8mm Hole  
1993-On  
UNIT PACKAGE: 25



**19904**  
(9133417-7)  
Black Nylon

Rocker Panel  
Push-Type Retainer  
Head Diameter: 16mm  
Stem Length: 14mm  
Fits Into 9mm Hole  
850 Series  
1994 - On  
UNIT PACKAGE: 15



**20407**  
(9133073-8)  
Black Nylon

Hood Insulation &  
Radiator Seal Push-Type Retainer  
Head Size: 8mm x 25mm  
Stem Length: 10mm  
Fits Into 5mm Hole  
850, 940, 960, S80, S90 & V90  
1991 - On  
UNIT PACKAGE: 25

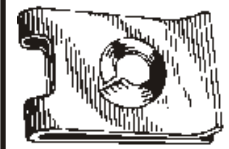

**13220**  
(Mercedes  
000-994-09-45;  
Volvo 946-418;  
Opel 20-72-175)  
Plated

"U" Type Nut  
6.3mm Screw Size  
Panel Range: .7mm-1.5mm  
Center of Hole To Edge: 13mm  
UNIT PACKAGE: 50

You Can E-Mail Your  
New Item Suggestions  
To [mail@auveco.com](mailto:mail@auveco.com)

## UNIVERSAL EUROPEAN IMPORT FASTENERS

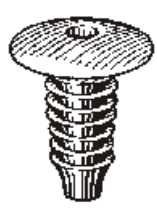

**16132**  
Black Nylon  
Trim Panel Retainer  
Head Dia: 19mm  
Stem Length: 20mm  
Fits Into 8mm Hole  
UNIT PACKAGE: 25



**16134**  
Zinc & Yellow  
Thread Cutting Nut  
With Sealer  
For 3mm Stud  
13.5mm O.D.  
8mm Hex  
UNIT PACKAGE: 25