

IMPORT PARTS

| | PAGE |
|------------------------------------|------|
| ASIAN AND EUROPEAN | |
| ACURA | .603 |
| HONDA | .611 |
| HYUNDAI | .629 |
| INFINITY | .630 |
| KIA | .632 |
| LEXUS | .633 |
| MAZDA | .639 |
| MISC. ASIAN | .644 |
| MITSUBISHI & CHRYSLER IMPORT | .646 |
| NISSAN-DATSUN | .649 |
| SUBARU | .660 |
| TOYOTA | .661 |
| EUROPEAN | |
| AUDI | .586 |
| BMW | .586 |
| JAGUAR | .588 |
| MERCEDES | .589 |
| MISC. EUROPEAN | .599 |
| VOLKSWAGEN | .593 |
| VOLVO | .597 |

AUDI

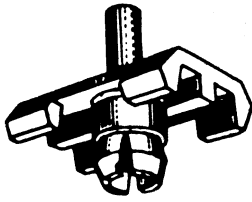

76-4285
Replaces: 803-853-139C
CLIP-MOULDING
Red
Volkswagen, Audi, Simca
UNIT PACKAGE 100



81-5304
Replaces: 431-853-139
CLIP-BODY MOULDINGS
VW, Audi & Other German Cars
UNIT PACKAGE 50

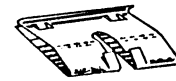

82-5480
Replaces: 435-853-394
**CLIP-WINDSHIELD
REVEAL MOULDING**
Audi 4000, 5000 & Quattro
UNIT PACKAGE 50



99-8762
Replaces: 1H5-863-849-A01C
RETAINER-HOOD INSULATION
Plastic - Textured
Audi & Volkswagen '98/ .
UNIT PACKAGE 15

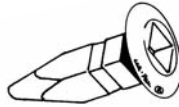

99-8564
Replaces: N908-214-01
GROMMET-BUMPER & FENDER APRON
Plastic
Screw: M4, Hole: 7.4MM, Flange: 15MM,
O/L: 21.3MM, P.R.: 0.7-2.2MM
VW Cabrio, Golf, Jetta & Phaeton '99/ &
Audi A4/S4, A6/S6 '96/
UNIT PACKAGE 15

**LOOKING FOR
A COST
RECOVERY
SYSTEM?
GO TO:
www.thepro.com**

BMW

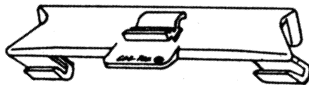

88-6441
Replaces: 5131-1938-494
**CLIP-WINDSHIELD
MOULDING**
Plastic
BMW 7 Series '87/
UNIT PACKAGE 15

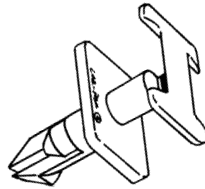

98-7865
Replaces: 51711-928-946
RIVET-DRIVE TYPE COWL VENT
Plastic
Hole: M6, Head: 10 x 12MM, P.R.: 3.5MM
BMW 5 & 7 Series
UNIT PACKAGE 25

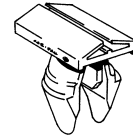

99-8190
Replaces: 51718-108-613
**RETAINER-COWL VENT
& TRUNK TRIM**
Plastic, Use w/99-8330
Hole: M8, Head: 11 X 14MM, O/L: 14MM
BMW 3, 7 & 8 Series '91/
UNIT PACKAGE 25

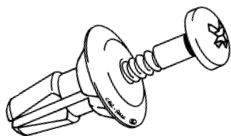

99-8684
Replaces: 51218-205-295
RIVET-SCREW TYPE
Cowl Vent
Formerly 99-8188
Plastic - use with 99-8189
BMW 5 Series '97/
UNIT PACKAGE 50



99-8189
Replaces: 51718-786-501
SEAL-COWL VENT
Rubber - use with 99-8684
BMW 5 and 7 Series '95/
UNIT PACKAGE 25

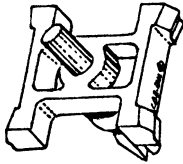

99-8330
Replaces: 51138-124-389
**GROMMET/SEAL-COWL VENT,
ROOF RAIL & TRUNK**
Plastic, Use w/99-8190
Hole: M9, Flange: 13MM,
Stem Lgth: 11MM
BMW 3, 7 & 8 Series '91/
UNIT PACKAGE 100

**85-6005**

Replaces: 5113-1848-664
CLIP-BODY SIDE MOULDING
 Plastic
 BMW 320i
UNIT PACKAGE 25

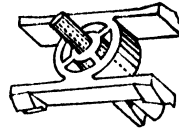
**85-6006**

Replaces: 5113-1849-724
 & 5113-1829-904
CLIP-BODY SIDE MOULDING
 Plastic
 BMW 320i
UNIT PACKAGE 25

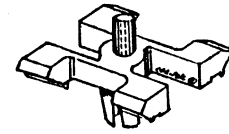
**86-6018**

Replaces: 5113-1816-019
CLIP-BODY SIDE MOULDING
 Plastic
 BMW 2002
UNIT PACKAGE 25

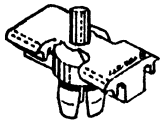
**86-6020**

Replaces: 5113-1808-841
CLIP-BODY, SIDE MOULDING
 Plastic
 BMW 528, 530 & Bavaria
UNIT PACKAGE 50

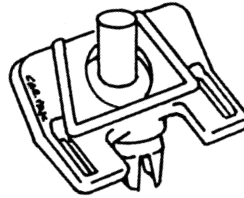
**88-6440**

Replaces: 5113-1876-128
CLIP-BODY SIDE MOULDING
 Plastic
 BMW 218i & 325e '83/
UNIT PACKAGE 25

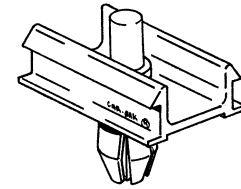
**98-7863**

Replaces: 51131-946-258
CLIP-DRIVE TYPE SIDE MOULDING
 Plastic
 Hole: M7, P.R.: 2MM
 BMW 5 Series
UNIT PACKAGE 25

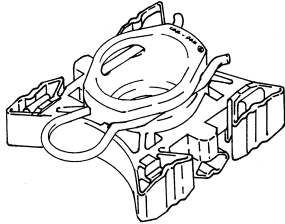
**99-8194**

Replaces: 51321-938-884
GUIDE-WINDOW REGULATOR
 Plastic with attaching clip
 BMW 3 and 5 Series '92 - '99
UNIT PACKAGE 2

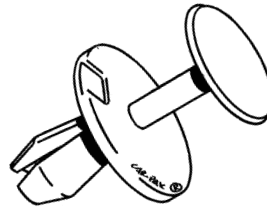
**98-7864**

Replaces: 51481-938-725
RIVET-DRIVE TYPE HOOD & TRUNK INSULATION
 Plastic
 Hole: M7, Flange: 20MM, P.R.: 4MM
 BMW 7 5+M3 Series '89/
UNIT PACKAGE 25

**99-8184**

Replaces: 51161-881-149, 000-990-34-92,
 N102-593-01, 5073327AA
RIVET-DRIVE TYPE
 Front Bumper
 Plastic
 Hole: M5, Flange: 10MM, P.R.: 3-8MM
 BMW 3, 5 & 8 Series '91/
 Mercedes GL, M, SL & SLK '98/
 VW, Dodge Pick-Up 2002/
UNIT PACKAGE 50

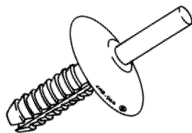
**99-8192**

Replaces: 51111-944-537
RIVET-DRIVE TYPE
 Front Bumper, Rear Wheel Opening
 Liner, Scuff Plate, Interior Trim
 Plastic
 Hole: M6, Flange: 20MM,
 Stem Lgth.: 15MM
 BMW 3, 5, 7 and X5 Series '89/
UNIT PACKAGE 50

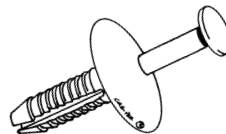
**99-8193**

Replaces: 51118-174-185
RIVET-DRIVE TYPE
 Front and Rear Bumper Cover,
 Front Bumper Grille
 Plastic
 Hole: M6, Flange: 20MM,
 Stem Lgth.: 17MM
 BMW 3, 5 & 7 Series '95/
UNIT PACKAGE 50

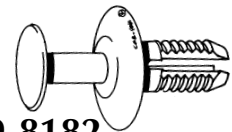
**99-8182**

Replaces: 201-990-02-92,
 81471-911-992, 30820141
RIVET-DRIVE TYPE
 Hood/Trunk Insulator, Rocker Panel,
 Rear Bumper & Engine Undercover
 Plastic
 Hole: M8, Flange: 20MM, P.R.: 11MM
 Mercedes C, CL, CLK, E, ML & S Class '92/
 BMW 7 & 8 Series '00/ Mini Cooper 2007/
 Volvo S/V40 2000-2004
UNIT PACKAGE 25

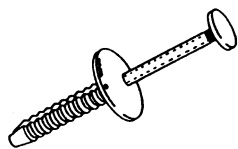
**91-6910**

Replaces: 51111-964-186
RIVET-DRIVE TYPE

Front Spoiler
Plastic

Hole: M6, 14.5MM Flange,
GR 8-15MM
BMW 3 Series '89/
UNIT PACKAGE 25

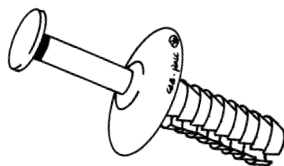
**99-8329**

Replaces: 51111-908-077, N903-591-01
RIVET-DRIVE TYPE

Bumper Cover, Trunk Trim & Scuff Plate
Plastic

Hole: M6.3, Flange: 15MM,
Stem Lgth: 15MM, P.R.: 3-8MM
BMW 3, 5, 7 Z3 & M Series '84/, VW
UNIT PACKAGE 50

**99-8774**

Replaces: 51717-002-953
**BLIND RIVET-FENDERS &
ROCKER MOULDING**

Plastic

M5.6 Rivet, 20MM Flange,
G.R.: 2.5-4.8MM
BMW X5 2000/
UNIT PACKAGE 25

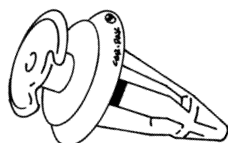
**99-8331**

Replaces: 51411-973-500
RETAINER-DOOR PANEL

Plastic

Hole: M9, Upper Hd: 14.5MM,
Trim Thk: 2.5MM, O/L: 20.5MM
BMW 3, 5 & 7 Series '87/
UNIT PACKAGE 50

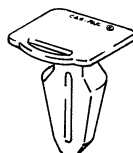
**99-8185**

Replaces: 51471-840-960

RETAINER-SCUFF PLATE
Plastic

Hole: M5.7, Flange: 9 x 12MM
BMW 3, 5, Z3 & M Series '92/
UNIT PACKAGE 25

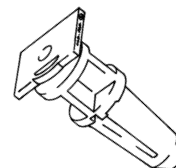
**99-8191**

Replaces: 51471-928-808

RETAINER-SCUFF PLATE
Plastic

Hole: M9, Flange: 12x15MM, O/L: 29MM
BMW 3, 5, & 7 Series '95/
UNIT PACKAGE 25

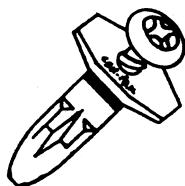
**88-6442**

Replaces: 51131-885-399

RIVET-SCREW TYPE
Grille & Headlamp

Door Attaching
Plastic

Hole: M6 Sq., P.R.: 2 - 7MM
BMW 5 & 7 Series '82/
UNIT PACKAGE 25

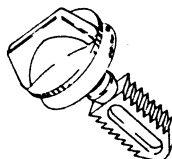
**91-6911**

Replaces: 51711-916-197

RETAINER-HEADLAMP COVER

Plastic use w/91-6912

BMW 3, 5 & 7 Series '84/
UNIT PACKAGE 25

**91-6912**

Replaces: 51711-916-199

GROMMET
HEADLAMP COVER

Plastic

Use w/91-6911
BMW 3, 5, & 7 Series '84/
UNIT PACKAGE 25

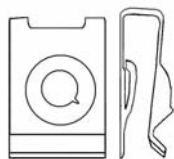
**99-8637**

Replaces: 07129-925-734, 07129-901-656

U-NUT - TAPPING

M4.8 (#10), 12.5x20MM,
P.R.: 2.5-3.5, Finish: Zinc
BMW 3, 7, 8 & Z3 '91/
UNIT PACKAGE 50

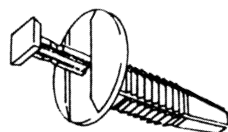
**96-7560**

Replaces: N808847-S, C2S13233
**RIVET-DRIVE TYPE, TRUNK TRIM
& COWL VENT**

Hole: M6.3, Head: 25MM

P.R.: 4-8MM

Black Plastic

Ford Taurus, Sable '96/, Jaguar X Type 2002/
UNIT PACKAGE 25

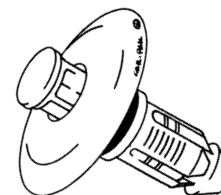
JAGUAR**99-8265**

Replaces: W705956-S300, XR8 7508

RIVET - DRIVE TYPE

Cowl Grille & Lower Radiator Cover
Plastic w/seal

Hole: M9, Shoulder: 3 X 10MM,

Flange: 25MM, Stem Lgth: 13MM
Lincoln LS 2000/, Jaguar 'S' Type '01/
UNIT PACKAGE 10

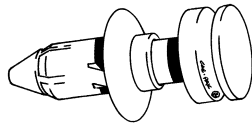

2 PART

99-8323

Replaces: 1W6Z-238A90-AA,
XR8 19630 PIN, 1W6Z-238A91AA,
XR8 21729 GROMMET
RETAINER - DOOR PANEL
Plastic
Hole: M9.5-10.25, Upper Hd.: 15MM,
Trim Thk: 2.4MM, O/L: 32.6MM, P.R.: .8-1.2MM
Ford T.Bird, Lincoln 2001,
Jaguar 'S' Type 2000/
UNIT PACKAGE 25

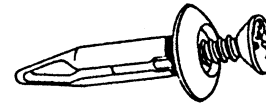
**86-6096**

Replaces: N-804570-S,
20664092, 6502790& C2S9354
RIVET-COWL, INTERIOR TRIM, GRILLE, ROCKER PNL.,
WHEEL LIP MOULDING, REAR BUMPER
Black Plastic,
Hole: M6.3, 2.5MM - 8.0MM
Grip Range, Washer Face Dia.: 18.0MM
Ford, G.M., Chrysler Products,
Cadillac '98/ & Jaguar X Type 2002
UNIT PACKAGE 25

MERCEDES**80-5192**

Replaces: 003-988-20-78
CLIP-GRILLE
Mercedes
UNIT PACKAGE 100

**80-5191**

Replaces: 003-988-19-78, 201-988-25-78
CLIP-GRILLE
Mercedes
UNIT PACKAGE 100

**76-4310**

Replaces: 001-988-56-78
CLIP-GRILLE MOULDING
Mercedes
UNIT PACKAGE 100

**76-4312**

Replaces: 002-988-09-78
CLIP-GRILLE MOULDING
Mercedes
UNIT PACKAGE 50

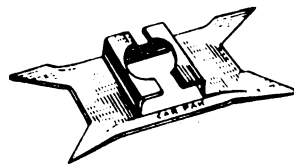
**76-4323**

Replaces: 000-994-06-45
CLIP-GRILLE, Mercedes
UNIT PACKAGE 50

**89-6633**

Replaces: 000-990-03-92
& 947-098
RIVET-DRIVE TYPE
Air Intake Cowl Grille
Hole: M4, 6MM P.R., 9MM Flange
Plastic
Mercedes, Volvo
UNIT PACKAGE 25

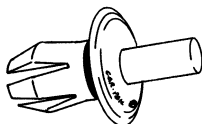
**99-8183**

Replaces: 161-867-299-01C,
000-990-29-92
RIVET-DRIVE TYPE
Rear Bumper & Splash Shield
Plastic
Hole: M8, Flange: 16MM, P.R.: 4-7MM
Volkswagon Cabrio, Golf, Jetta & Passat '90/
Mercedes
UNIT PACKAGE 15

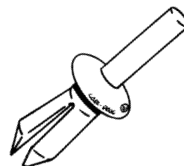
**99-8180**

Replaces: 000-990-25-92
RIVET-DRIVE TYPE
Cowl & Front Bumper
Plastic
Hole: M6, Flange: 10MM, P.R.: 2-8MM
Mercedes E Class '96/
UNIT PACKAGE 25

**99-8184**

Replaces: 51161-881-149, 000-990-34-92,
N102-593-01, 5073327AA
RIVET-DRIVE TYPE
Front Bumper
Plastic
Hole: M5, Flange: 10MM, P.R.: 3-8MM
BMW 3, 5 & 8 Series '91/
Mercedes GL, M, SL & SLK '98/
VW, Dodge Pick-Up 2002/
UNIT PACKAGE 50

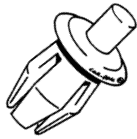
**98-7866**

Replaces: N038-550-1, 123-990-02-92

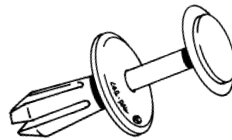
RIVET-DRIVE TYPEFENDER SPLASH SHIELD, HOOD &
TRUNK INSULATOR
PlasticHole: M8, Flange: 12.5MM, P.R.: 4MM
VW Golf & Jetta '97/
Mercedes CL & SL '90/
UNIT PACKAGE 25**99-8521**

Replaces: 001-990-13-92

RIVET-BACKGLASS MOULDING
PlasticHole: M5, Flange: 15MM,
Stem Lgth: 11MM, P.R.: 3-6MM
Mercedes C & SL Class 2001/
UNIT PACKAGE 15**99-8548**

Replaces: 000-990-37-92

RIVET-INTERIOR TRIM
PlasticHole: M8-8.6, Flange: 8MM,
Stem Lgth: 15MM, P.R.: 5.5-10MM
Mercedes '99/
UNIT PACKAGE 15**99-8642**

Replaces: 123-990-00-92

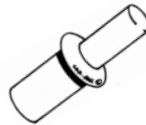
RIVET-DRIVE TYPE, RADIATOR SHROUD
PlasticHole: M8.5, Pin Head/Flange: 12MM,
Stem Lgth: 10MM, P.R.: 4MM
Mercedes CL, E & S Class '96/
UNIT PACKAGE 10**99-8754**

Replaces: 000-990-84-92

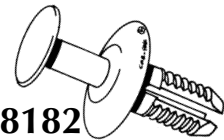
**RIVET-DRIVE TYPE, INTERIOR &
TRUNK TRIM**
PlasticHole: M6, Flange: 10MM,
Stem Lgth: 10MM, P.R.: 8MM Max
Mercedes 'E' & 'C' Class 2001/
UNIT PACKAGE 25**99-8182**Replaces: 201-990-02-92,
81471-911-992, 30820141**RIVET-DRIVE TYPE**Hood/Trunk Insulator, Rocker Panel,
Rear Bumper & Engine Undercover
PlasticHole: M8, Flange: 20MM, P.R.: 11MM
Mercedes C, CL, CLK, E, ML & S Class '92/
BMW 7 & 8 Series '00/ Mini Cooper 2007/
Volvo S/V40 2000-2004
UNIT PACKAGE 25**99-8660**

Replaces: 124-990-04-92

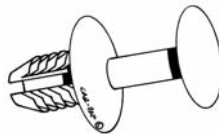
RIVET-DRIVE TYPE, FENDER & GRILLE
PlasticHole: M7
Mercedes C, CLK, CLS,
E, M & R Class 2001/
UNIT PACKAGE 15**99-8693**

Replaces: 230-990-01-92

RIVET-DRIVE TYPE, HOOD INSULATOR
PlasticHole: 8, Flange: 20MM,
Stem Lgth: 9.5MM, P.R.: 5MM
Mercedes GL, M, R, SL & SLK 2005/
UNIT PACKAGE 15**99-8638**Replaces: 000-990-40-92,
124-990-05-92-9051**RIVET-SCREW TYPE, ENGINE COVER &
INTERIOR TRIM**
PlasticHole: M5, Flange: 12MM,
Stem Lgth: 11MM, P.R.: 6MM
Mercedes 190D/E, E & CLK Class '84-2005
UNIT PACKAGE 15**99-8639**

Replaces: 000-990-44-92

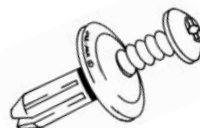
RIVET-SCREW TYPE,
PlasticHole: M5, Shoulder: 6X2.7MM
Flange: 12MM,
Stem Lgth: 11MM, P.R.: 8MM
Mercedes 56, 380, 460 & 500 Class
UNIT PACKAGE 15**99-8640**

Replaces: 000-990-46-92

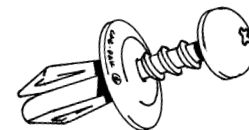
RIVET-SCREW TYPE, ROCKER MOLDING
PlasticHole: M6.3, Flange: 17MM,
Stem Lgth: 15MM, P.R.: 9.5MM
Mercedes C & CLK Class '94-2003
UNIT PACKAGE 5**99-8520**

Replaces: 123-990-05-92, 126-990-03-92

RIVET-COWL COVER
PlasticHole: M6.3, Flange: 16MM,
Stem Lgth: 11MM, P.R.: 5MM
Mercedes E, CL & S Class 2000/
UNIT PACKAGE 15

**99-8461**

Replaces: 463-988-02-78
RETAINER-DOOR PANEL
 Plastic

Hole: M8, Upper Hd: 11.5MM, O/L:19MM,
 P.R.: 1.5MM, Trim Thk: 2.5MM
 Mercedes G500 & G55 2002/
 UNIT PACKAGE 25

**99-8460**

Replaces: 007-988-34-78, 007-988-99-78
RETAINER-FRONT & REAR DOOR PANEL
 Plastic w/Seal

Hole: M8, Upper Hd: 13MM, O/L: 19MM,
 Trim Thk: 2.3MM, P.R.: 1MM
 Mercedes '96/
 UNIT PACKAGE 10

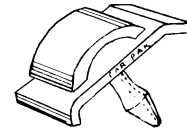
**80-5193**

Replaces: 000-988-56-81
CLIP-MOULDING
 Mercedes
 UNIT PACKAGE 50

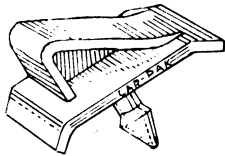
**80-5194**

Replaces: 000-988-78-81
CLIP-MOULDING
 Mercedes
 UNIT PACKAGE 50

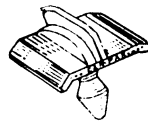
**80-5195**

Replaces: 000-988-60-81
CLIP-MOULDING
 Mercedes
 UNIT PACKAGE 50

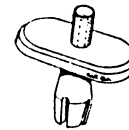
**84-5823**

Replaces: 004-988-94-78
CLIP-MOULDING
 Plastic
 Mercedes
 UNIT PACKAGE 50

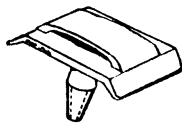
**84-5825**

Replaces: 000-988-75-81
CLIP-ROCKER PANEL MOULDING
 Plastic
 Mercedes 115 - 123
 UNIT PACKAGE 25

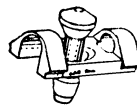
**84-5828**

Replaces: 004-988-76-78
 & 004-988-77-78
CLIP-MOULDING
 Plastic
 Mercedes 126 Chassis
 UNIT PACKAGE 25

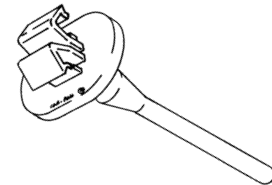
**99-8186**

Replaces: 140-698-00-82
RETAINER-ROCKER PANEL MOULDING
 Plastic
 Mercedes S Class 2000/
 UNIT PACKAGE 25

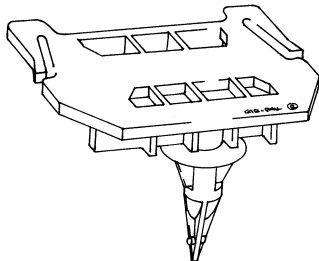
**99-8474**

Replaces: 211-988-00-81
RETAINER-COWL COVER
 Plastic, Hole: M9
 Mercedes E, CL & S Class 2000/
 UNIT PACKAGE 10

**84-5824**

Replaces: 000-988-10-15
RETAINER-TRIM
 Plastic
 Mercedes Model 123
 UNIT PACKAGE 25

**99-8547**

Replaces: 003-988-41-78
RETAINER-INTERIOR TRIM
 Plastic
 Hole: M7.5, Head: 13MM, O/L: 16MM,
 Stem Lgth: 11MM, P.R.: 0.88MM
 Mercedes '66-'95
 UNIT PACKAGE 15

**99-8641**

Replaces: 000-990-57-92
RETAINER-DECK LID PANEL
 Plastic
 Hole: M8, Head: 13MM,
 O/L: 16MM, Trim Thk: 1.5MM
 Mercedes S, SL, CL & E Class '86-2005
UNIT PACKAGE 15

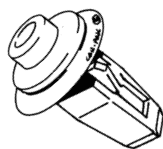
**99-8179**

Replaces: 000-988-86-25
GROMMET-ROCKER PANEL MOULDING
 Plastic
 Hole: M8, Flange: 14MM,
 P.R.: 1.8-2,3MM, Screw: M4.8 (#8)
 Mercedes CL, E & S Class '96/
UNIT PACKAGE 25

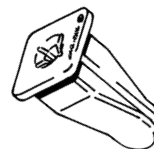
**99-8187**

Replaces: 000-988-16-25
GROMMET-COWL VENT
 Hole: M7.2, Flange 9.5MM,
 Stem Lgth: 14MM, P.R.: 3.5MM,
 Screw M3.5 (#6)
 Plastic
 Mercedes CL and S Class 2000/
UNIT PACKAGE 50

**99-8643**

Replaces: 000-997-91-86
PLUG
 Plastic
 Hole: M6, O/L: 13.5MM, P.R.: 3.5MM
 Mercedes 420/550 SEL Class '80-'91
UNIT PACKAGE 10

**99-8177**

Replaces: 001-988-76-81
GROMMET-FENDER MOULDINGS
 Plastic
 Hole: M9, Flange: 11.5MM,
 P.R.: 0.8-11.1MM
 Mercedes C, E, CLK, S & SLK Class '96/
UNIT PACKAGE 25

**99-8178**

Replaces: 000-988-55-81
GROMMET-ROCKER PANEL MOULDING
 Plastic - Blue
 Hole: M9, Flange: 10.5MM, P.R.: 1.25MM
 Mercedes CL & S Class '92/
UNIT PACKAGE 50

**76-4263**

Replaces: 000-988-15-81
**NUT-PUSH IN NAME PLATES
 AND INSIGNIA,**
 Plastic - Red
 Slot Size 4.3 MM, Hole: 9MM
 Mercedes '65/
UNIT PACKAGE 100

**99-8181**

Replaces: 201-997-22-81
NUT-TUBULAR
 Hood and Trunk Emblem
 Plastic
 Hole: M5.75, Flange: 7MM, O/L: 7.25MM
 Mercedes C, CL, CLK, E,
 SLK and S class '96/
UNIT PACKAGE 50

**99-8499**

Replaces: 002-997-33-86, 20538173
**RETAINER-FRONT FENDER,
 WEATHERSTRIP**
 Plastic
 Hole: M4.75, Head: 11MM,
 Stem Lgth.: 12MM, P.R.: 0.8-6.5MM
 Mercedes C, CLK, E & SL Class '98/
 G.M. '90/
UNIT PACKAGE 50

**99-8511**

Replaces: 201-990-00-50
NUT-FRONT FENDER APRON
 Plastic, Self Threading
 M4.8, Flange: 24MM, A/F: 10MM
 Mercedes C, CLK & E CLASS '98/
UNIT PACKAGE 25

**99-8644**

Replaces: 001-990-00-91
U-NUT - WELD TYPE
 M6-1.0, P.R.: .5-1.7MM,
 Throat Depth: 15MM,
 Finish: Yellow Zinc
 Mercedes 56, 380, 460, 500 &
 SL400/500 class & General Purpose
UNIT PACKAGE 5

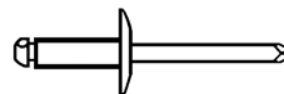
**J03862**

Replaces: 003-990-24-97
**BLIND RIVET-DOOR HANDLE,
 AIR BAGS, ROCKER MLD.,
 WINDOW REGULATOR**
 Rivet: M4.8(3/16), Flange: 9.5MM(3/8),
 G.R.: 1.6-3.2MM (.063-.125)
 Mercedes Various Models '98/
UNIT PACKAGE 100

VOLKSWAGEN

85-5917
Replaces: 175-845-183
WINDSHIELD FILLER STRIP
For Glue in Windshields
Volkswagen Rabbit '83/
UNIT PACKAGE 5

85-6000
Replaces: 176-845-183
WINDSHIELD GASKET
Filler Strip
For Glue in Windshields
Volkswagen Golf '83/
UNIT PACKAGE 5

98-7867
Replaces: 1H0-819-055-B-01C
SCREW-COWL VENT
Plastic
M6.5-1.5 X 16MM, Head: 23MM
Textured
VW Golf & Jetta '97/
UNIT PACKAGE 25

75-4192
Replaces: 823-853-397A
CLIP-WINDOW MOULDING TRIM
White
Volkswagen Dasher
UNIT PACKAGE 100

75-4193
Replaces: 823-853-397
CLIP-WINDOW MOULDING TRIM
Black
Volkswagen Dasher '74/'79
UNIT PACKAGE 100

80-5196
Replaces: 171-853-585A
CLIP-MOULDING
White
Hole: M4.3, Width: 6.25MM,
Length: 18MM
Volkswagen
UNIT PACKAGE 100

80-5189
Replaces: 321-853-139
CLIP-SIDE MOULDINGS
White
Hole: M4.3, Width: 9.5MM,
Length: 18MM
Volkswagen Dasher '78/
UNIT PACKAGE 25

81-5304
Replaces: 431-853-139
CLIP-BODY MOULDINGS
White
Hole: M8.3, Width: 9.3MM,
Length: 18MM
VW, Audi & Other German Cars
UNIT PACKAGE 50

81-5305
Replaces: 803-853-139A
CLIP-ROCKER PANEL MOULDING
White
Hole: M6.5, Width: 9.5MM,
Length: 18MM
VW Rabbit & Scirocco
UNIT PACKAGE 50

76-4285
Replaces: 803-853-139C
CLIP-MOULDING
Red
Hole: M6.6, Width: 9.3MM,
Length: 18MM
Volkswagen, Audi, Simca
UNIT PACKAGE 100

80-5190
Replaces: 311853587
RETAINER-ROCKER PANEL MOULDING
Black
Hole: M8.5, Width: 11.5MM,
Length: 22MM
Volkswagen
UNIT PACKAGE 50

79-4978
Replaces: 175-853-695
RIVET-GRILLE MOULDINGS
Plastic
Volkswagen Pick-up Truck '80/
UNIT PACKAGE 25

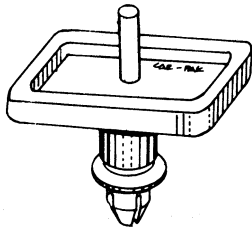
**83-5616**

Replaces: 161-807-806
CLIP-BUMPER FILLER PANEL
 Between Bumper & Panel
 VW Scirocco '78 - '81 & Jetta '80
UNIT PACKAGE 25

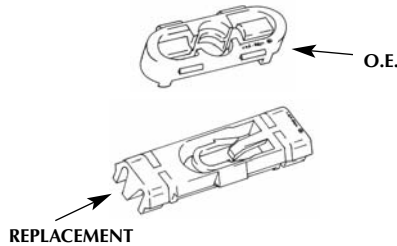
**99-8586**

Replaces: 1H0-853-733B
RETAINER-ROOF DRIP MOLDING
 Plastic
 VW Golf, Jetta & Cabrio '93-'99
UNIT PACKAGE 25

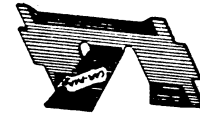
**71-4037**

Replaces: 113-853-559-A
CLIP-RUNNING BOARD
MOLDING
 Volkswagen '66/
UNIT PACKAGE 100

**81-5429**

Replaces: N-90132901
RIVET-FENDER FLAP RETAINING
 Hole: M8, Flange: 12MM,
 Stem Lgth: 8.5MM
 Volkswagen
UNIT PACKAGE 50

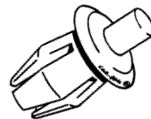
**98-7866**

Replaces: N038-550-1, 123-990-02-92
RIVET-DRIVE TYPE
 FENDER SPLASH SHIELD, HOOD &
 TRUNK INSULATOR
 Plastic
 Hole: M8, Flange: 12.5MM, P.R.: 4MM
 VW Golf & Jetta '97/
 Mercedes CL & SL '90/
UNIT PACKAGE 25

**99-8184**

Replaces: 51161-881-149, 000-990-34-92,
 N102-593-01, 5073327AA
RIVET-DRIVE TYPE
 Front Bumper
 Plastic
 Hole: M5, Flange: 10MM, P.R.: 3-8MM
 BMW 3, 5 & 8 Series '91/
 Mercedes GL, M, SL & SLK '98/
 VW, Dodge Pick-Up 2002/
UNIT PACKAGE 50

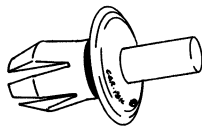
**99-8183**

Replaces: 161-867-299-01C,
 000-990-29-92
RIVET-DRIVE TYPE
 Rear Bumper & Splash Shield
 Plastic
 Hole: M8, Flange: 16MM, P.R.: 4-7MM
 Volkswagon Cabrio, Golf, Jetta & Passat '90/
 Mercedes
UNIT PACKAGE 15

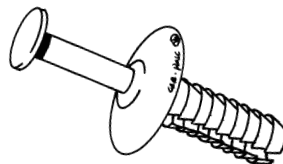
**99-8329**

Replaces: 51111-908-077, N903-591-01
RIVET-DRIVE TYPE
 Bumper Cover, Trunk Trim & Scuff Plate
 Plastic
 Hole: M6.3, Flange: 15MM,
 Stem Lgth: 15MM, P.R.: 3-8MM
 BMW 3, 5, 7 Z3 & M Series '84/, VW
UNIT PACKAGE 50

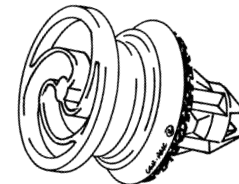
**99-8152**

Replaces: 3B0-868-243
RETAINER-DOOR PANEL
 (SPRING STYLE HEAD), Plastic
 Hole: M10, Head Dia.: 22MM,
 Stem Length: 10MM
 Volkswagon Golf, Jetta,
 Passat & Beetle '98/
UNIT PACKAGE 25

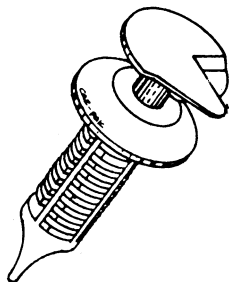
**82-5490**

Replaces: 175-867-299
CLIP-TRIM PADS
 Volkswagen
UNIT PACKAGE 50

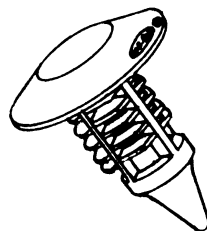
**85-5952**

Replaces: N90282401, 3096724
CLIP-DOOR TRIM PANELS FENDERS
 M8 Hole
 Volkswagen Rabbit, G.M. S10 2004/
UNIT PACKAGE 50

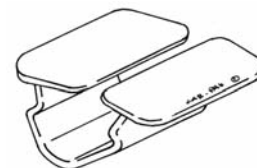
**99-8762**

Replaces: 1H5-863-849-A01C
RETAINER-HOOD INSULATION
 Plastic - Textured
 Audi & Volkswagen '98/.
UNIT PACKAGE 15

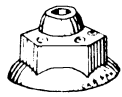
**78-4933**

Replaces: 171-853-939
NUT-EMBLEMS.
 WHEEL HOUSE MOULDINS
 Rubber
 General Purpose
 Volkswagen '64/
UNIT PACKAGE 100

**78-4910 (J01970)**

Replaces: 179-813-883
GROMMET-REAR QUARTER
 EXTENSION MOULDING
 Hole: M7sq., Flange: 10MM,
 Stem Lgth: 8MM, Screw: M3.5(#6)
 Volkswagen Pick-up '79/
UNIT PACKAGE 100

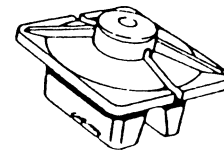
**89-6641**

Replaces: N90206501
NUT-GROMMET M6 SCREW
 Front Lower Spoiler
 Plastic
 Rectangular Hole 10MM x 15MM
 Volkswagen All '85/
UNIT PACKAGE 25

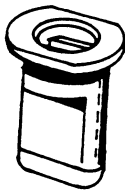
**88-6512**

Replaces: 171-853-615A
RETAINER-NAMEPLATE
 Plastic
 Volkswagen
UNIT PACKAGE 25

**99-8563**

Replaces: N908-338-01
GROMMET-FENDER APRON
 Plastic
 Screw: M4, Hole: 7.4MM, Flange: 15MM,
 O/L: 13.6MM, P.R.: 1.0-3.0MM
 VW Cabrio, Golf, Jetta & Phaeton '99/
UNIT PACKAGE 15

**99-8564**

Replaces: N908-214-01
GROMMET-BUMPER & FENDER APRON
 Plastic
 Screw: M4, Hole: 7.4MM, Flange: 15MM,
 O/L: 21.3MM, P.R.: 0.7-2.2MM
 VW Cabrio, Golf, Jetta & Phaeton '99/ &
 Audi A4/S4, A6/S6 '96/
UNIT PACKAGE 15

**99-8510**

Replaces: 357-827-998
GROMMET-FRT. & REAR DOOR PANEL
 Plastic
 Hole: M8 sq. Flange: 16MM,
 O/L: 21MM, P.R.: 1MM, Screw M4.8(#10)
 VW Golf, Jetta, Passat & Cabrio '93/
UNIT PACKAGE 15

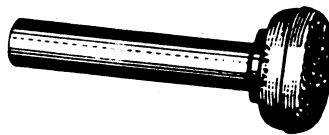
**72-3607**

DOOR LOCK KNOB
 Chrome Plated
 Volkswagen '67 - '72
UNIT PACKAGE 25

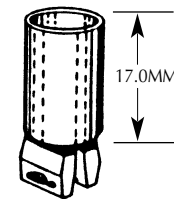
**85-5959**

Replaces: 176-807-995
SPACER NUT-LICENSE PLATE
 M6 Screw
 Volkswagen Rabbit '84
UNIT PACKAGE 25

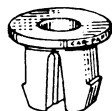
**92-7062 (J02478)**

Replaces: 175-867-949
NUT-LICENSE PLATE
 Plastic
 M6 Screw
 General Purpose
 VW Rabbit '79/
UNIT PACKAGE 25

**87-6267**

Replaces: N-900-845-01
BLIND RIVET-WHEEL OPENING
 MOULDING
 Black Aluminum Rivet w/Steel Mandrel
 5/32" Rivet w/15/32" Flange,
 1/4-3/8" Grip Range
 VW Jetta, Rabbit & Golf '84/
UNIT PACKAGE 25

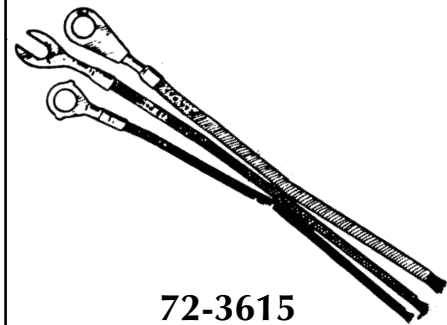
**72-3615**

REPAIR HARNESS GENERATOR
 12" Leads
 Volkswagen
UNIT PACKAGE 12

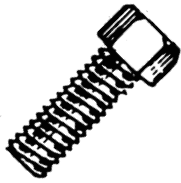
**80-5250**

Replaces: N-402043
CAP SCREW-BALL JOINT REPLACEMENT
 M7 - 1.0 x 20MM
 10.9 Grade
 Volkswagen
UNIT PACKAGE 50

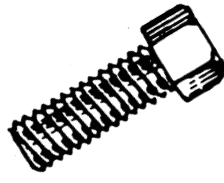
**80-5251**

Replaces: N-1024213
CAP SCREW-FRONT & REAR BUMPER
 M8-1.25 x 25MM
 10.9 Grade
 General Usage
 Volkswagen
UNIT PACKAGE 50

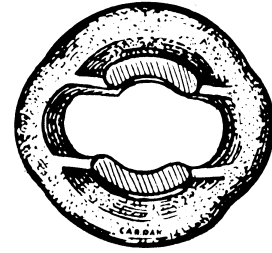
**76-4275**

Replaces: 823-253-147A
EXHAUST SUSPENSION RING
 Rubber
 Volkswagen Dasher
UNIT PACKAGE 25

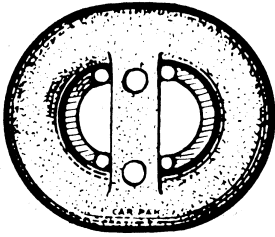
**76-4274**

Replaces: 171-253-147
EXHAUST SUSPENSION RING
 Rubber
 Volkswagen, Golf & Scirocco
UNIT PACKAGE 25

**70-3399**

Replaces: 113255271
SPRING-HEADLAMP TENSION
 Volkswagen '67/
UNIT PACKAGE 25

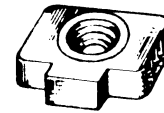
**72-3742**

Replaces: 311-941-145
NUT-HEADLAMP ADJUSTING
 Nylon
 Volkswagen '67/
UNIT PACKAGE 25

**70-3394**

Replaces: 311-941-141A
SCREW-HEADLAMP ADJUSTING
 Slotted Head
 M5 x 37MM Length
 Volkswagen '67 - '72
UNIT PACKAGE 10

**72-3741**

Not Supplied From OEM
SCREW-HEADLAMP ADJUSTING
 M5
 Volkswagen '67
UNIT PACKAGE 25

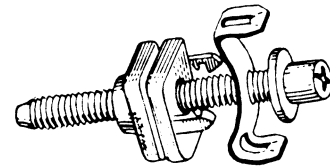
**79-4994**

Replaces: 113-941-141B
SCREW-ADJUSTING NUT & SCREW ASSEMBLY
 Volkswagen Rabbit
UNIT PACKAGE 10

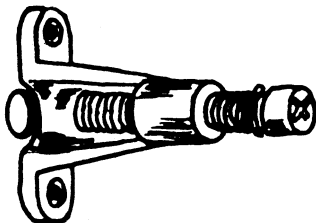
**81-5339**

SCREW- ADJUSTING SCREW & NUT ASSEMBLY
 Volkswagen Rabbit
UNIT PACKAGE 12

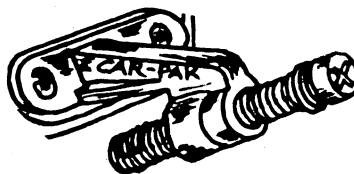
**81-5340**

Replaces: 20374473
SCREW-HEADLAMP ADJUSTING & NUT ASSEMBLY
 Volkswagen Rabbit
UNIT PACKAGE 12

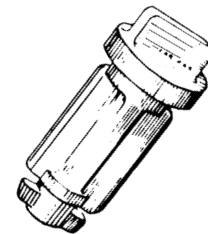
**79-4995**

Replaces: 113-941-133
HEADLAMP SPACER
 Volkswagen
UNIT PACKAGE 50

VOLVO



79-4983
 Replaces: 1254849
CLIP-WINDSHIELD
MOULDING SLIDING CENTER
 White
 Volvo 240/260 '78-'90
UNIT PACKAGE 25



79-4984
 Replaces: 1255552
CLIP-WINDSHIELD MOULDING
 Stationary Center
 Black
 Volvo 240/260 '78-'90
UNIT PACKAGE 25

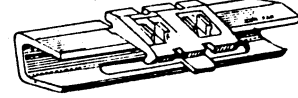

79-4985
 Replaces: 1246934
CLIP-WINDSHIELD
MOULDING SLIDING CENTER
 Green/White
 Volvo 240/260 '78-'90
UNIT PACKAGE 25



79-4986
 Replaces: 1246926
CLIP-WINDSHIELD MOULDING
 Stationary Center
 Gray
 Volvo 240/260 '78-'90
UNIT PACKAGE 50

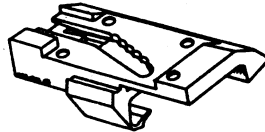

87-6238
 Replaces: 1342004
CLIP-WINDSHIELD MOULDING
 Upper & Side
 Volvo 740, 760, 940, 960,
 S90 & V90 '85-'98
UNIT PACKAGE 25

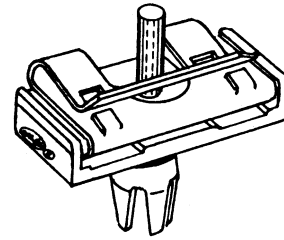

84-5849
 Replaces: 1304967
CLIP-BUMPER COVER MOULDING
 Plastic
 Volvo 240 & 260 '83/
UNIT PACKAGE 25

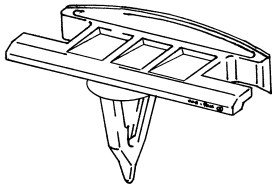

99-8160
 Replaces: 9151649-2
CLIP-ROCKER MOULDING
 Plastic
 Hole: M8, P.R.: 0.8-1.0MM
 Volvo 850, C70, S70, V70 '93/
UNIT PACKAGE 10

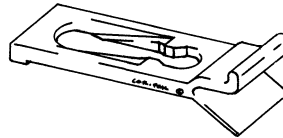

99-8159
 Replaces: 1372920-7
CLIP-RADIATOR GRILLE
 Plastic
 Volvo 850 '93 - '99
UNIT PACKAGE 15



89-6633
 Replaces: 000-990-0329
 & 947-098
RIVET-DRIVE TYPE
 Air Intake Cowl Grille
 Hole: M4, 6MM P.R., 9MM Flange
 Plastic
 Mercedes, Volvo
UNIT PACKAGE 25

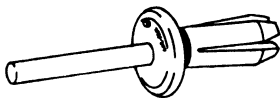

96-7544
 Replaces: 1268176-3
RIVET-DRIVE TYPE BUMPER
 Plastic Black
 Hole: 6MM, Head: 15.8MM
 Stem Length: 14MM
 Lower
 Volvo 740, 760, 850 & S80 Models '88/
UNIT PACKAGE 25



99-8161
 Replaces: 3512624-2
RIVET-DRIVE TYPE
 Rocker Panel Moulding
 Hole:M8, Flange: 16MM, P.R.: 4-7MM
 Volvo 850 '93 - '97
UNIT PACKAGE 15

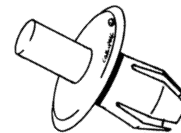

99-8162
 Replaces: 9133417-7
RIVET-DRIVE TYPE
 Rocker Panel Moulding
 Hole: M8, Flange: 16MM, PR: 8MM Max.
 Volvo Various Models '84/
UNIT PACKAGE 25

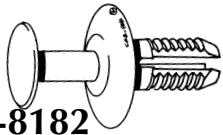
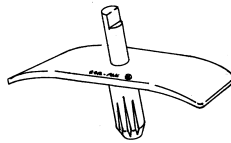
**99-8182**Replaces: 201-990-02-92,
81471-911-992, 30820141**RIVET-DRIVE TYPE**Hood/Trunk Insulator, Rocker Panel,
Rear Bumper & Engine Undercover
PlasticHole: M8, Flange: 20MM, P.R.: 11MM
Mercedes C, CL, CLK, E, ML & S Class '92/
BMW 7 & 8 Series '00/ Mini Cooper 2007/
Volvo S/V40 2000-2004
UNIT PACKAGE 25**99-8163**Replaces: 9133073-8
RETAINER-HOOD & RADIATOR SEAL
PlasticHole: M5, Flange: 8 X 25MM,
P.R.: Max 6MM
Volvo 850, S80, 940, 960, S90, V90 '91/
UNIT PACKAGE 25

PLASTIC COATED

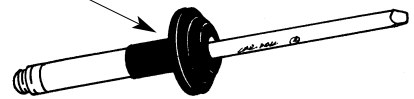
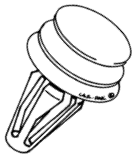
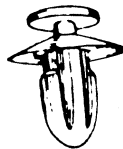
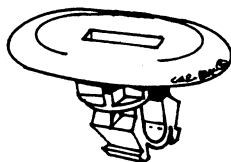
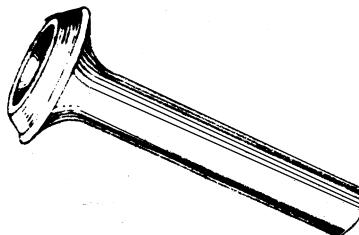
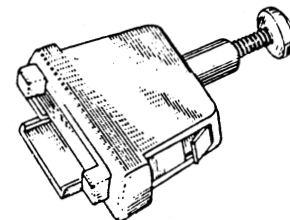
**99-7913**Replaces: 979878-6
BLIND RIVET- LEG RETENTION STYLE
WHEEL OPENING & BUMPERSBlack Plastic Coated Aluminum Rivet
w/Aluminum Mandrel
M5 Rivet, Flange: 12MM,
G.R.: 5.18-5.35MM
Volvo '93/
UNIT PACKAGE 15**99-8166**Replaces: 8611997-1
RETAINER-DOOR PANEL &
INTERIOR TRIM
PlasticHole: M8, Stem Lgth.: 12MM
P.R.: 0.7-2.0MM
Volvo C70, S70, V70 '98/
UNIT PACKAGE 25**71-4008**Replaces: 860097
FASTENER-TRIM PAD
PlasticVolvo
UNIT PACKAGE 50**71-4010**944519
FASTENER-TRIM PAD
Plastic VioletVolvo
UNIT PACKAGE 50**71-4018**Replaces: 679898
CLIP-MOULDINGVolvo
UNIT PACKAGE 50**99-8164**Replaces: 9165325-3, 9132306-3
RETAINER-HOOD AND TRUNK
INSULATORPlastic - paint to match
Hole: M8, Head: 21 MM, P.R.: 3.2-7.5MM
Volvo C70, S70, V70, S80 '98/
UNIT PACKAGE 25**99-8165**Replaces: 1318908-9
GROMMET-FRONT BUMPER
PlasticHole: M9.5 Sq., Flange: 14MM,
P.R.: 0.7-2.5MM
Volvo 740, 850, 940, 960, C70, S70,
V70, S90, V90 '88/
UNIT PACKAGE 25**89-6603**Replaces: 3519357, 1379250
CLIP-HOOD INSULATIONPlastic, Oval Shaped
Volvo '83/
UNIT PACKAGE 25**72-3581**Not Supplied By O.E.
DOOR LOCK KNOBChrome Plated
Volvo '70/
UNIT PACKAGE 25**72-3599**Replaces: 681923
SCREWHEADLIGHT ADJUSTING
Volvo '71 - '72, 140 Series
UNIT PACKAGE 25

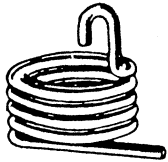

72-3600
 Replaces: 676109
SPRING-HEADLIGHT ADJUSTING
 Volvo 140 Series
UNIT PACKAGE 50

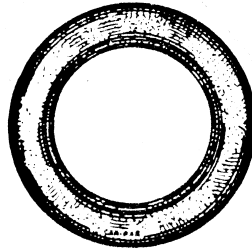

76-4280
 Replaces: 676184
EXHAUST SUSPENSION RING
 Rubber
 Volvo
UNIT PACKAGE 25



76-4279
 Replaces: 666407
EXHAUST SUSPENSION RING
 Rubber
 Volvo
UNIT PACKAGE 25

MISCELLANEOUS EUROPEAN

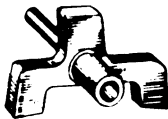

71-4023
 7159395, BD-31053/1
CLIP-MOULDING
 Vauxhall, Jaguar
UNIT PACKAGE 50



71-4025
 7162188-CZA-6508
CLIP-MOULDING
 Vauxhall,
 British Motor Car Corp.
UNIT PACKAGE 50

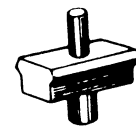

71-4026
 7165725 626595
CLIP-MOULDING
 Vauxhall, Triumph
UNIT PACKAGE 50



71-4027
 Replaces: 7182149
CLIP-MOULDING
 Vauxhall
UNIT PACKAGE 50



71-4028
 625953-9129586,
 CZG-3123
CLIP-MOULDING
 Triumph, Chrysler
 British Motor Car Corp.
UNIT PACKAGE 50



71-4029
 120-285-ES-A 1/2
CLIP-MOULDING
 Ford, Capri, Escort, Cortina
UNIT PACKAGE 50



71-4030
 E-864-064ES-629647, 369696
CLIP-MOULDING
 Ford, Triumph, Rover
UNIT PACKAGE 50



71-4032
 CZG-4565
CLIP-MOULDING
 British Motor Car Corp.
UNIT PACKAGE 50



71-4033
 E-464-021-S
CLIP-MOULDING
 English Ford Models, Capri '69 - '71
UNIT PACKAGE 50



71-4034
2702807
CLIP-MOULDING
Vauxhall
UNIT PACKAGE 50

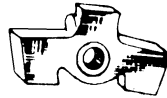

71-4016
CZK-3469
CLIP-MOULDING
British Motor Car Corp.
UNIT PACKAGE 50

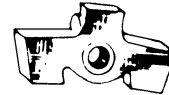

71-4017
CLIP-MOULDING
Triumph
UNIT PACKAGE 50



71-4021
6395432
CLIP-MOULDING
Vauxhall
UNIT PACKAGE 50



71-4022
6395433
CLIP-MOULDING
Vauxhall
UNIT PACKAGE 50



71-4020
7204166, 617243
CLIP-MOULDING
Chrysler, Triumph
UNIT PACKAGE 50



71-4024
7096040
CLIP-MOULDING
Chrysler
UNIT PACKAGE 50



71-4019
8821908
CLIP-MOULDING
Vauxhall
UNIT PACKAGE 50



71-4006
7187294
FASTENER-TRIM PAD
Black Plastic
Vauxhall
UNIT PACKAGE 50



71-4004
9131189 8823224 BD 34981
CLIP-TRIM PAD
Plastic
Jaguar, Cricket '71- '72, CZH-817
British Motor Car Corp.
62170/0271 British Leyland
UNIT PACKAGE 50



71-4011
CZK 3631
CLIP-TRIM PAD
Plastic Gray
British Motor Car Corp.
UNIT PACKAGE 50

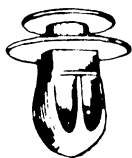

71-4013
62130/0719
FASTENER-TRIM PAD
Plastic White
Pressed Steel
UNIT PACKAGE 50

**71-4001**

Replaces: E-866-008-S
FASTENER-TRIM PAD
 Grey
 English Ford Products
UNIT PACKAGE 50

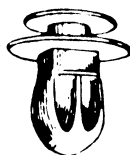
**71-4000**

Replaces: 115-217-ES
FASTENER-TRIM PAD
 Black
 English Ford Products
UNIT PACKAGE 50

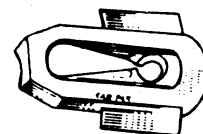
**76-4290**

CLIP-MOULDINGS
 Opel
UNIT PACKAGE 50

**72-3613**

Replaces: 112873
CLIP-FUEL LINE CABLE
 Capri
UNIT PACKAGE 50

**72-3612**

Replaces: 105E-7020930
CLIP-DOOR BELT WEATHERSTRIP
 Capri
UNIT PACKAGE 50

**79-5016**

Replaces: E-864-8475
CLIP-WEATHERSTRIP
 Fiesta '78/
UNIT PACKAGE 50

**79-5017**

Replaces: E-864-687S
CLIP-WEATHERSTRIP
 Fiesta '78/
UNIT PACKAGE 50

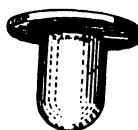
**72-3643**

CLIP-RETAINER, DOOR PANEL TRIM
 I.D.: 6.7MM, O/L: 15.5MM,
 Flange: 16.4MM
 European & Japanese Cars
UNIT PACKAGE 100

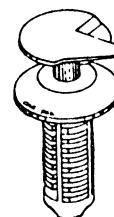
**88-6486**

Replaces: 14188180
CLIP-DOOR TRIM PANEL
 Plastic
 Yugo '86/
UNIT PACKAGE 25

**72-3610**

Replaces: 120324-ES
RETAINER-TRIM PAD
 Capri
UNIT PACKAGE 50

**81-5426**

CLIP & WASHER-CARPET RETAINING
 German & Japanese Cars
UNIT PACKAGE 25

**71-4014**

Replaces: 111-297-ES100
TEE-BOLT-WHEEL HOUSE MOULDING
 Ford Cortina '67 - '71, Capri '68 - '71
UNIT PACKAGE 50

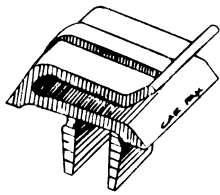
**81-5390**

Replaces: 8089731731
NUT-HEADLIGHT DOOR
 Pick-up Truck
 G.M. Luv Truck
UNIT PACKAGE 25

**86-6014**

SCREW-HEADLAMP ADJUSTING
 M5-0.8 x 23MM, Phillips Recess
 Lada
UNIT PACKAGE 50

**72-3614**

Replaces: 120196
CLIP-LINKAGE RETAINER
 Capri
UNIT PACKAGE 50

**72-3620**

Replaces: 120220-ES
RETAINER-THROTTLE CABLE
 Capri
UNIT PACKAGE 50

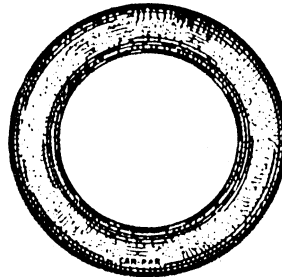
**76-4271**

Replaces: DORY-5A231-C
EXHAUST SUSPENSION RING
 Ford Capri '71/
UNIT PACKAGE 25

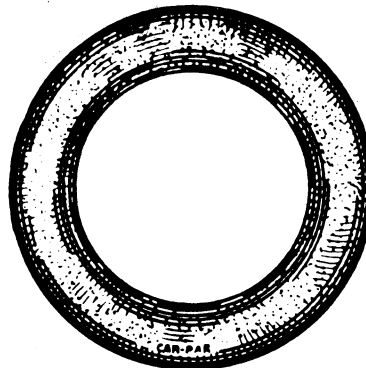
**76-4272**

Replaces: 852-711
EXHAUST SUSPENSION RING
 Rubber
 Opel
UNIT PACKAGE 25

76-4273

Replaces: 852-705
EXHAUST SUSPENSION RING
 Rubber
 Opel
UNIT PACKAGE 25

**REGISTERED USERS
 GET UPDATES AT:
www.carpak.com**

DOOR WINDOW BRACKET IMPORTS

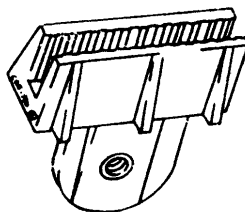
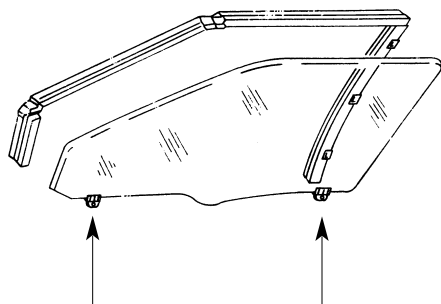

93-7102

Replaces: 69951-12180
BRACKET DOOR WINDOWS
 Plastic w/M6-1.0 Threaded, Steel Insert
 Import and Various Domestic Vehicles
UNIT PACKAGE 5

ACURA

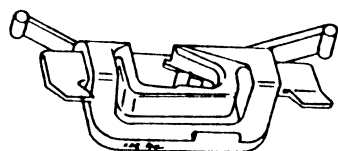

88-6401

Replaces: 90675-SC5-003
CLIP-WINDSHIELD MOULDING
 Gray Plastic
 Acura Legend 2 Door '86-'90
 Honda Accord '86-'89
UNIT PACKAGE 10

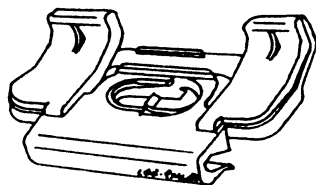

88-6400

Replaces: 90658-SG0-004
CLIP-WINDSHIELD MOULDING
 Gray Plastic
 Acura Legend 2 Door '87
UNIT PACKAGE 10



88-6408

Replaces: 95102-SG0-003
CLIP-WINDSHIELD MOULDING
 White Plastic
 Acura Legend '88/
UNIT PACKAGE 10

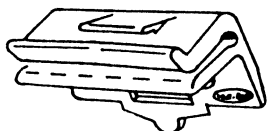

88-6404

Replaces: 90683-SD2-003
 67811-SG3-003
CLIP-WINDSHIELD MOULDING
 Plastic Narrow Groove
 Acura Integra '86/
UNIT PACKAGE 10

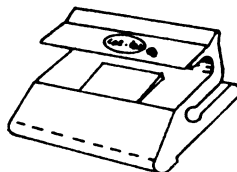

88-6402

Replaces: 90657-SD4-003
CLIP-WINDSHIELD MOULDING
 Black Plastic
 Acura Legend 4 Door '86/
UNIT PACKAGE 10

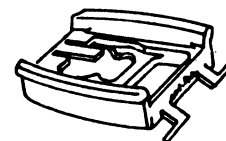

88-6406

Replaces: 90656-SD4-000
CLIP-WINDSHIELD MOULDING
 Plastic
 Acura Legend 4-Door '86/
UNIT PACKAGE 10



88-6405

Replaces: 90684-SD2-003
CLIP-WINDSHIELD MOULDING
 Plastic Wide Groove
 Acura Integra '86/
UNIT PACKAGE 10

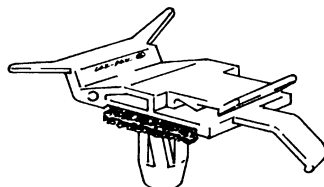

96-7510

Replaces: 90677-SD2-003
CLIP-QUARTER GLASS MOULDING
 White Plastic
 Acura Integra '86 - '89
UNIT PACKAGE 5

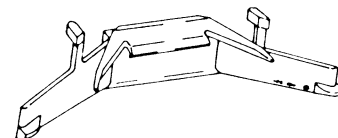

92-7010

Replaces: 91512-SP0-003
CLIP-WINDSHIELD MOULDING UPPER
 White Plastic
 Acura Legend 4 Door '91-'95
UNIT PACKAGE 10

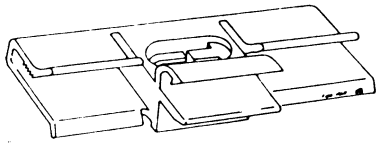
**92-7008**

Replaces: 91528-SP0-003
CLIP-WINDSHIELD MOULDING SIDE
 Yellow Plastic
 (use w/92-7009 or 93-7206)
 Acura 2 & 4 Door '91-'99
 Honda Accord '94-'98
UNIT PACKAGE 15

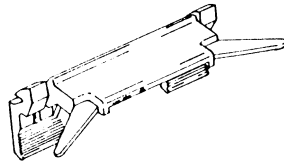
**92-7009**

Replaces: 91529-SP0-003
CLIP-WINDSHIELD MOULDING SIDE
 Black Plastic (use w/92-7008) Acura
 Legend 4 Door '91/
UNIT PACKAGE 15

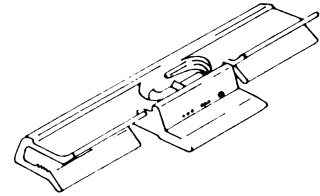
**92-7006**

Replaces: 91511-SP0-003
CLIP-WINDSHIELD MOULDING SIDE
 Blue Plastic (use w/92-7007)
 Acura 2&4 Door '91-'99
 Honda Accord '94-'98
UNIT PACKAGE 10

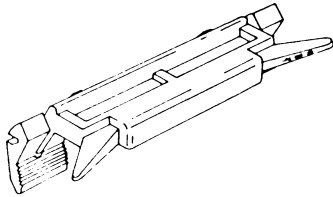
**92-7007**

Replaces: 91513-SP0-003
CLIP-WINDSHIELD MOULDING SIDE
 Blue Plastic (use w/92-7006) Acura Legend
 4 Door '91-'95
UNIT PACKAGE 10

**94-7325**

Replaces: 91535-SP0-003
CLIP-WINDSHIELD CORNER
 Green Plastic
 Acura Legend 4 Door '91-'95
UNIT PACKAGE 5

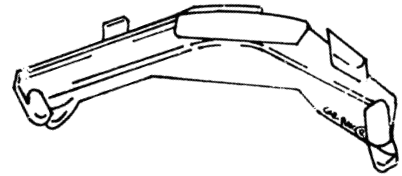
**94-7324**

Replaces: 91536-SP0-003
CLIP-WINDSHIELD CORNER
 Blue Plastic
 Acura Legend 4 Door '91-'95
UNIT PACKAGE 5

**96-7533**

Replaces: 91524-SP0-003
CLIP-WINDSHIELD MOULDING
 Rear Upper
 White Plastic
 Acura Legend '91-'95
UNIT PACKAGE 10

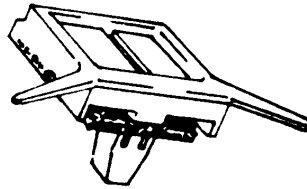
**94-7259**

Replaces: 91537-SP0-0030
CLIP-WINDSHIELD MOULDING
 Lower Moulding
 Plastic w/Sealer
 Acura Legend '91/
UNIT PACKAGE 5

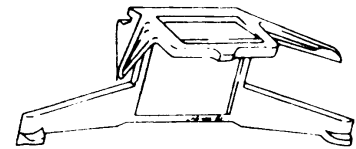
**94-7323**

Replaces: 91526-SP0-003
CLIP-WINDSHIELD SIDE
 White Plastic
 Acura Legend 4 Door '91-'95
UNIT PACKAGE 5

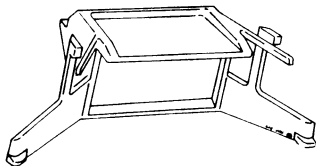
**94-7322**

Replaces: 91514-SP0-003
CLIP-WINDSHIELD SIDE
 Yellow Plastic
 Acura Legend 4 Door '91-'95
UNIT PACKAGE 5

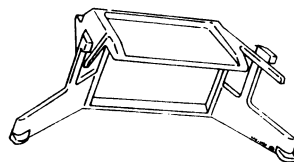
**94-7327**

Replaces: 91526-SP1-003
CLIP-WINDSHIELD SIDE
 Blue Plastic
 Acura Legend 2 Door '91-'95
UNIT PACKAGE 5

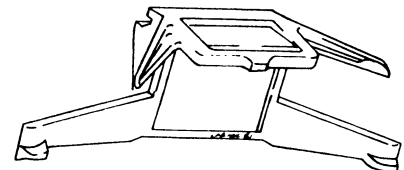
**94-7328**

Replaces: 91514-SP1-003
CLIP-WINDSHIELD SIDE
 Red Plastic
 Acura Legend 2 Door '91-'95
UNIT PACKAGE 5

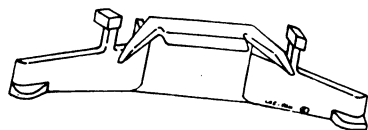
**94-7302**

Replaces: 91512-SP1-000
CLIP-WINDSHIELD UPPER
 Brown Plastic
 Acura Legend 2 Door '91-'95
UNIT PACKAGE 5

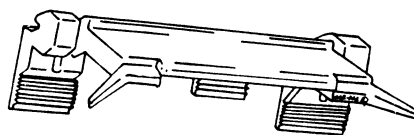
**94-7290**

Replaces: 91528-SP1-003
CLIP-WINDSHIELD SIDE
 Yellow Plastic
 Acura Legend 2 Door '91-'95
UNIT PACKAGE 5

94-7291

Replaces: 91529-SP1-003
CLIP-WINDSHIELD SIDE
 Brown Plastic
 Acura Legend 2 Door '91-'95
UNIT PACKAGE 5

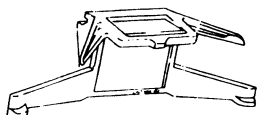
**94-7326**

Replaces: 91527-SP1-003
CLIP-WINDSHIELD SIDE
 Green Plastic
 Acura Legend 2 Door '91-'95
UNIT PACKAGE 5

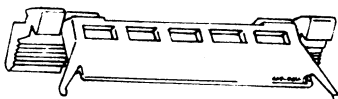
**94-7289**

Replaces: 91513-SP1-003
CLIP-WINDSHIELD SIDE
 Gray Plastic
 Acura Legend Coupe '91-'95
UNIT PACKAGE 10

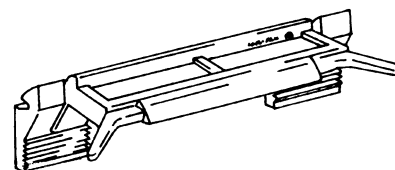
**96-7534**

Replaces: 91513-SP1-003
CLIP-WINDSHIELD MOULDING
 Front Side
 Gray Plastic
 Acura Legend '91-'95
UNIT PACKAGE 5

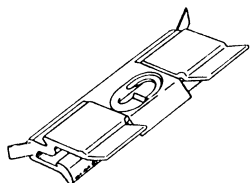
**92-7034**

Replaces: 91569-SL4-003
CLIP-WINDSHIELD MOULDING SIDE
 White Plastic (use w/92-7033) Acura
 Vigor '92-'94
UNIT PACKAGE 25

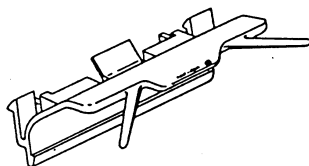
**92-7033**

Replaces: 91567-SL4-003
CLIP-WINDSHIELD MOULDING SIDE
 Black Plastic (use w/92-7034)
 Acura Vigor '92-'94
UNIT PACKAGE 25

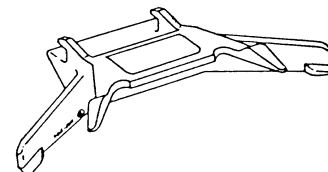
**92-7032**

Replaces: 91568-SL4-003
CLIP-WINDSHIELD MOULDING SIDE
 Black Plastic
 Acura Vigor '92-'94
UNIT PACKAGE 15

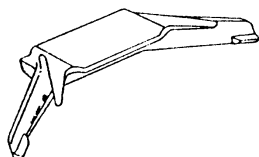
**92-7031**

Replaces: 91572-SL4-003
CLIP-WINDSHIELD MOULDING
 UPPER
 Black Plastic
 Acura Vigor '92-'94
UNIT PACKAGE 10

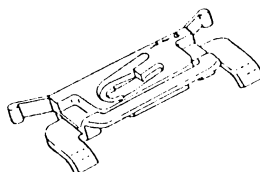
**92-7030**

Replaces: 91579-SL4-003
CLIP-WINDSHIELD MOULDING UPPER
 Black Plastic
 Acura Vigor '92-'94
UNIT PACKAGE 25

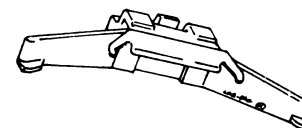
**94-7301**

Replaces: 90612-SK7-003
CLIP-WINDSHIELD SIDE
 White Plastic
 Acura Integra '90 - '93
UNIT PACKAGE 10

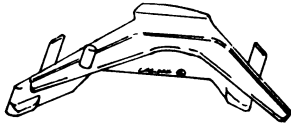
**94-7320**

Replaces: 90611-SK7-003
CLIP-WINDSHIELD CORNER
 White Plastic
 Acura Integra '90 - '93
UNIT PACKAGE 5

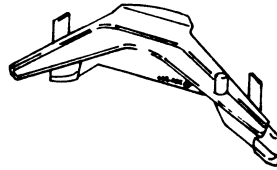
**94-7321**

Replaces: 90621-SK7-003
CLIP-WINDSHIELD CORNER
 Black Plastic
 Acura Integra '90 - '93
UNIT PACKAGE 5

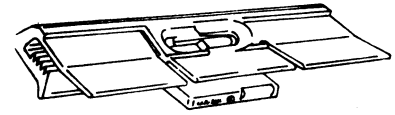
**94-7292**

Replaces: 90601-SK7-003
CLIP-WINDSHIELD SIDE
 Green Plastic
 Acura Integra 3 & 4 Door '90 - '93
UNIT PACKAGE 15

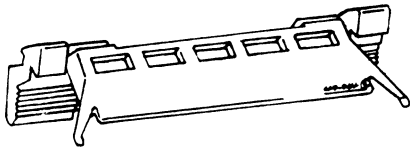
**94-7293**

Replaces: 90602-SK7-003
CLIP-WINDSHIELD SIDE
 Green Plastic
 Acura Integra 3 & 4 Door '90 - '93
UNIT PACKAGE 15

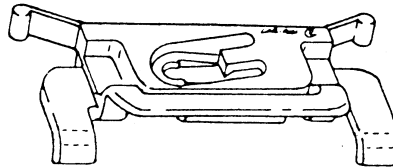
**90-6735**

Replaces: 91534-SM4-003
CLIP-WINDSHIELD MOULDING UPPER
 White Plastic
 Honda Accord '90/
 Acura Legend '91-'98
UNIT PACKAGE 15

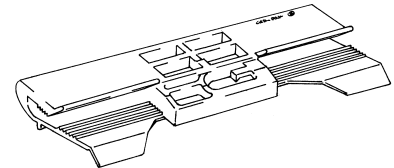
**99-8369**

Replaces: 91520-S5A-003
RETAINER - WINDSHIELD SIDE MOULDING
 Plastic
 Honda Civic 2001/ & Acura 1.7EL 2001
UNIT PACKAGE 25

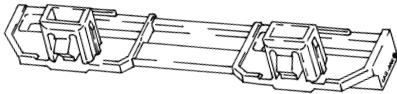
**99-8371**

Replaces: 91567-S3M-A01
RETAINER - WINDSHIELD UPPER MOULDING
 Plastic
 Use w/99-8372
 Honda Civic 2001 / & Acura 3.2CL,
 3.2TL '99/
UNIT PACKAGE 25

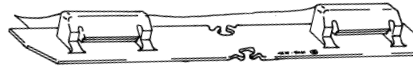
**99-8372**

Replaces: 91568-S3M-A01
RETAINER - WINDSHIELD UPPER MOULDING
 Plastic
 Use w/99-8371
 Honda Civic 2001/ & Acura 3.2CL, 3.2TL,
 MDX '99/
UNIT PACKAGE 5

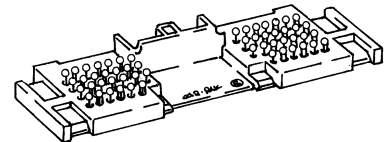
**99-8370**

Replaces: 91569-SZ3-013
RETAINER - BACK GLASS UPPER MOULDING
 Plastic (Adhesive)
 Honda Civic, Insight, Prelude '97/
 Acura 2.5TL, 3.2TL '95-'98
UNIT PACKAGE 5

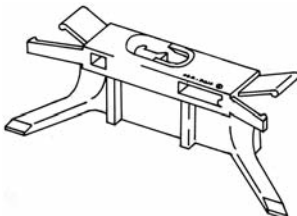
**99-8789**

Replaces: 91572-SDA-A01
RETAINER-WINDSHIELD & ROOF DRIP MOULDING
 Plastic-White
 Honda Accord, Pilot & Acura TL 2003/
UNIT PACKAGE 10

**99-8780**

Replaces: 91570-SDA-A01
RETAINER-WINDSHIELD & ROOF DRIP MOULDING
 Plastic-Blue
 Honda Accord, Pilot & Acura TL 2003/
UNIT PACKAGE 10

**99-8781**

Replaces: 91571-SDA-A01
RETAINER-WINDSHIELD & ROOF DRIP MOULDING
 Plastic-White
 Honda Accord & Acura TL 2003/
UNIT PACKAGE 10

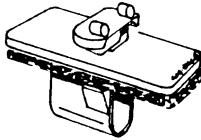
**89-6592**

Replaces: 90651-SD4-003
CLIP-FRONT DOOR SASH MOULDING
 Plastic w/Sealer
 Acura Legend '86/
UNIT PACKAGE 15

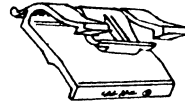
**89-6593**

Replaces: 90652-SD4-003
CLIP-FRONT DOOR REVEAL MOULDING
 Plastic
 Acura Legend '86/
UNIT PACKAGE 15

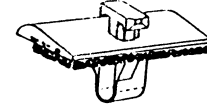
**89-6712**

Replaces: 90672-SD2-003
CLIP-FRONT DOOR SASH MOULDING
 W/Sealer, Plastic
 Acura Integra '88/
UNIT PACKAGE 15

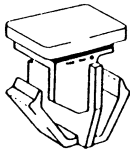
**90-6752**

Replaces: 75801-SD2-003
CLIP-BODY SIDE MOULDING
 Plastic-White
 Acura Integra '86-'89
UNIT PACKAGE 15

**99-8628**

Replaces: 75305-S0A-003
RETAINER-SIDE MOULDING
 Plastic-White
 Acura TL & RL '96-2004
 Honda Civic, CR-V, Odyssey & Pilot '97/
UNIT PACKAGE 15

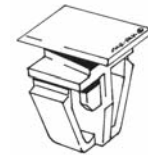
**99-8629**

Replaces: 75305-SH2-003
RETAINER-SIDE MOLDING
 Plastic-Blue
 Acura CL, TL RL & Legend '91/
 Honda Civic & CR-V '92/
UNIT PACKAGE 15

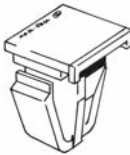
**99-8630**

Replaces: 75305-SH4-003
RETAINER-SIDE MOLDING
 Plastic-Red
 Acura TL '95-'98
 Honda Civic & CR-V '96/
UNIT PACKAGE 15

**99-8787**

Replaces: 75315-S9A-004,
 75315-STK-A01
RETAINER-EXT. DOOR MOULDING
 Plastic
 Hole: M10sq, Head: 12x15MM,
 O/L: 15MM, P.R.: 1.5MM,
 Trim Thk: 2.5MM
 Acrua RDX 2007/, Honda CR-V 2002/
UNIT PACKAGE 25

**89-6711**

Replaces: 90674-SD2-013
CLIP-LOWER DOOR MOULDING
 Plastic
 Acura Integra '88/
UNIT PACKAGE 100

**90-6724**

Replaces: 91506-SD4-921
RETAINER-DOOR MOULDING LOWER
 Narrow Chrome Moulding
(Retainer Only Plastic)
 Acura Legend '86 - '88
UNIT PACKAGE 25

**89-6667**

Replaces: 91501-SG0-003
CLIP-BODY SIDE MOULDING
 Green Plastic
 Acura Legend Coupe '87/
UNIT PACKAGE 125

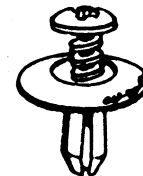
**90-6749**

Replaces: 91524-SE0-003
RIVET-SCREW TYPE COWL VENT
 Plastic
 Hole: M6, Grip Range: 5-7MM
 Washer Face: 17.5MM
 Honda Accord '86 - '89, Prelude &
 Odyssey '95/, Acura '92-'98
UNIT PACKAGE 25

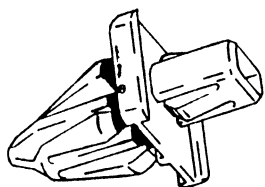
**95-7465**

Replaces: 90661-ST7-003

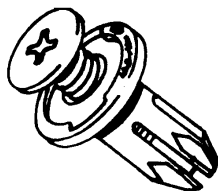
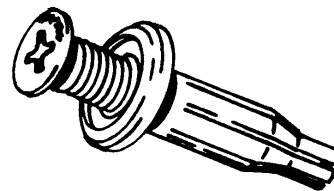
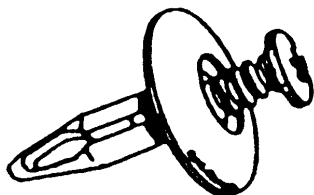
CLIP-BUMPERWhite Plastic
Acura Integra '94/
UNIT PACKAGE 5**94-7215**Replaces: 91503-SP0-003, 94530623
RIVET- SCREW TYPE, BUMPERS & GRILLE
PlasticHole: M10, Flange: 20MM, P.R.: 4-8MM
Honda '92/, Accura '91/,
Chevrolet Aveo 2004/
UNIT PACKAGE 10**94-7214**Replaces: 91502-SP0-003, 94530624
RIVET- SCREW TYPE BUMPERS
Hole: M10, Washer: 20MM, P.R.: 5-12MM
PlasticHonda '92/, Accura '91/
Saturn Vue 2008
UNIT PACKAGE 5**90-6787**

Replaces: 91502-SM4-000

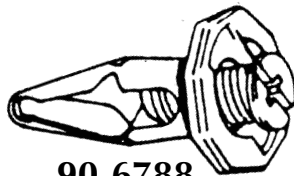
RIVET-SCREW TYPE**BUMPER FASCIA FRONT & REAR**
PlasticHole: M10, Flange: 20MM, P.R.: 6-9MM
Accura '92/, Honda '90/
UNIT PACKAGE 15**90-6788**

Replaces: 91504-SM4-000

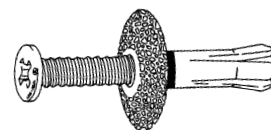
RIVET-SCREW TYPE**BUMPER FASCIA FRT. & REAR**Hole: M10,
Washer Head: 20MM Octagonal
P.R.: 6-9MM
PlasticHonda Accord '90/, Acura Vigor Rear '92
UNIT PACKAGE 10**97-7704**Replaces: MB888869, 90505-SL0-003,
90467-08155**RIVET-SCREW TYPE****Bumper Cover**
PlasticHole: M8, Stem: 20.5MM,
Panel: 13MM, HD 20MM
Chrysler, Mitsubishi, Acura, Toyota '93/
UNIT PACKAGE 15**99-8044**

Replaces: 90657-SB0-003

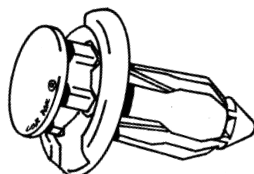
RIVET-DRIVE TYPE**BUMPER COVERS & FENDER WELLS**Hole: M6.3, Flange: 10.8MM, P.R.: 2.5MM
Honda Accord, Prelude,
Legend & Odyssey '83/
UNIT PACKAGE 10**98-7829**

Replaces: 91503-SZ3-003

RIVET- PIN DRIVE TYPE**BUMPER & FRONT GRILLE**
PlasticHole: M10, Flange: 20MM, P.R.: 5MM
Honda Cars & Odyssey '95/,
Element 2003 & Acura '95/, Fit 2007/
UNIT PACKAGE 15**98-7862**

Replaces: 91512-SX0-003

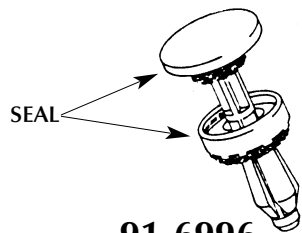
RIVET-DRIVE TYPE**Plastic****Front & Rear Fender Splash Shield**
Hole: M8, Flange: 20MM, P.R.: 4MM
Honda Accord & Prelude, Acura '94/
UNIT PACKAGE 25**91-6996**

Replaces: 91508-SM4-003

RETAINER-COWL GRILLE

Plastic

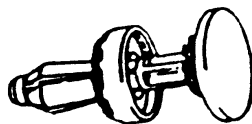
Hole: M8 Head Dia.: 17MM,
Stem Lgth: 10MM
Honda Accord '90/ & Acura 3.5RL '96-'02
UNIT PACKAGE 10**96-7529**

Replaces: 91508-SR3-000

RETAINER- COWL GRILLE

Black Plastic

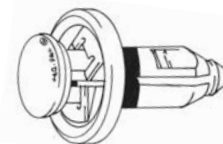
Hole: M7, Head: 17.5MM,
Stem Lgth: 9MM, P.R.: 0.80MM
Honda Civic '92, CRV '97/ &
Acura Integra '94-2001
UNIT PACKAGE 10**99-8705**Replaces: 91506-S9A-003
**DRIVE RIVET-BUMPER, UPPER &
LOWER ENGINE COVER**
Plastic w/Metal InsertHole: M10, Flange: 20MM,
Stem Lgth: 16MM, P.R.: 8MM
Acura MDX, RDX, TSX 2004/
Honda Civic & CR-V 2006/
UNIT PACKAGE 10

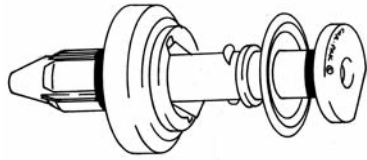
**99-8770**

Replaces: 91561-SJD-003
RETAINER-W/S GARNISH MOULDING
 Plastic, White Pin/Black Grommet
 Hole: M8.5, Flange: 18MM, O/L: 37MM,
 Top Hd: 15MM, Trim Thk: 5MM
 Acura RL, Honda Civic, Fit & Pilot 2005/
UNIT PACKAGE 5

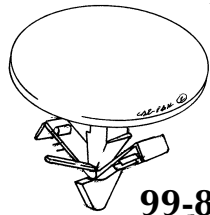
**99-8443**

Replaces: 91501-S1K-003, 91501-STK-003
RETAINER-HOOD INSULATOR
 Plastic
 Hole: M7, Head: 30MM,
 Stem Lgth: 14MM, O/L: 15.5MM
 Honda: Accord, Civic, CR-V, S2000 2000/
 Acura 3.5RL & RSX 2002/, Fit 2007/
UNIT PACKAGE 25

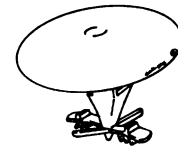
**96-7509**

Replaces: 90700-SJ4-000
CLIP-HOOD INSULATION
 Black Plastic
 Hole M7.5, Head Dia..30
 Panel Range 1.5-5.0mm
 Honda Odyssey '95/, Acura '91/
UNIT PACKAGE 15

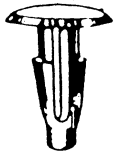
**89-6714**

Replaces: 90672-671-003
CLIP-COWL GRILLE & HEADLINER
 Hole: M5, Head: 12MM, P.R.: 5MM
 Gray Plastic
 Honda Accord '86/ & Acura Legend,
 2.5TL & 3.5 TL '91-'98
UNIT PACKAGE 25

**89-6672**

Replaces: 90687-SA5-003, 90467-08008
CLIP-COWL TOP, WEATHERSTRIP,
TRIM PANELS
 Black Plastic
 Hole: M5, Head: 13MM,
 Stem Lgth: 15MM, P.R.: 4MM
 Honda Accord '87/ & Acura Vigor '92-'94,
 Toyota
UNIT PACKAGE 25

**97-7719**

Replaces: 91518-SM4-003
RETAINER-HOOD SEAL
 Plastic
 Hole: M7, Head Dia: 12MM, Stem Lgth:
 9MM
 Honda & Acura '94/
UNIT PACKAGE 15

**96-7607**

Replaces: 91520-SM4-C01
CLIP- HOOD-SEAL
 Plastic-Black
 Hole Dia: M5, Head Dia: 10MM
 O/L: 14.4MM
 Honda, Acura '90/
UNIT PACKAGE 25

**99-8219**

Replaces: 91501-SL4-003
RETAINER - COWL VENT
 Plastic
 Hole: M6, Head: 13MM, P.R.: .5MM
 Acura 3.5 & Legend '91/
 Honda Civic 2001
UNIT PACKAGE 10

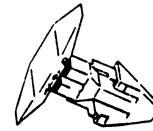
**95-7494**

Replaces: 91515-SR3-000
CLIP-WEATHER STRIP RET.
 Cowl
 Black Plastic
 Hole: M6, Head: 8MM x 17.8MM
 Honda Civic '93/, CR-V '97/ &
 Acura Integra '94-2001
UNIT PACKAGE 25

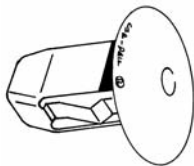
**99-8617**

Replaces: 90682-SEA-003
RETAINER-FENDER APRON
 Plastic
 Hole: 9MM Sq., Flange: 20MM,
 O/L: 14MM, P.R.: 3.5MM
 Honda Civic & Odyssey 2005/
 Acura TSX 2004/
UNIT PACKAGE 25

**99-8221**

Replaces: 90602-SX0-003
RETAINER - COWL VENT
 Plastic
 Hole: M4.2, O/L: 18MM,
 Upper Head: 12MM, Trim Thk: 2.7MM
 Acura MDX, Honda Civic, Insight,
 Odyssey & Prelude '95/, Element 2003/
UNIT PACKAGE 10

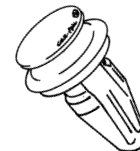
**99-8138**

Replaces: 91560-S84-A11
RETAINER-WINDSHIELD GARNISH PILLAR
 Plastic
 Hole: M8, Stem Lgth: 12MM,
 Middle Head: 16.5MM, Top Head: 13MM
 Acura 3.2CL & Honda Accord, Insight,
 Odyssey, S200 '98/, Element 2003/
UNIT PACKAGE 15

**97-7721**

Replaces: 91560-SP0-003, 91560-S84-A01
RETAINER- DOOR PANEL
 FRONT, REAR & SIDE PLASTIC
 Hole Dia: M9, Sm Head Dia: 13MM
 Slot: 2.5 x 5.75MM, Stem Lgth: 12MM
 Honda & Acura '99/
UNIT PACKAGE 50

**99-8368**

Replaces: 90602-S5A-003
RETAINER - COWL VENT
 Plastic
 Hole: M9, Upper Hd: 12 x 13MM,
 O/L: 20MM, Trim Thk: 3MM
 Honda Civic, CR-V & Acura, RSX 2001/
UNIT PACKAGE 15

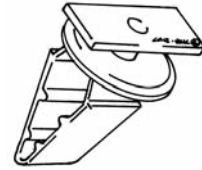
**99-8706**

Replaces: 90602-SLJ-003, 90603-SLJ-003
RETAINER-COWL VENT
 Plastic
 Slot: 7MM wide, Head: 10x14MM, O/L:
 18.5MM, P.R.: 2MM, Trim Thk: 2.8MM
 Acura RDX & Honda CR-V 2007/
UNIT PACKAGE 10

**99-8602**

Replaces: 91560-S9A-A01
RETAINER-DOOR PANEL
 Plastic
 Hole: M9, Upper Hd: 13MM, P.R.: 1.5MM,
 O/L: 19MM, Trim Thk.: 2.5MM
 Honda Accord, Civic, CR-V &
 Odyssey 2002/
 Acura TL & TSX 2004/
UNIT PACKAGE 25

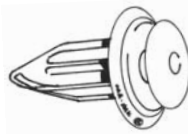
**99-8574**

Replaces: 90467-10188, 91560-S6A-003
RETAINER-COWL, W/S GARNISH,
 INTERIOR TRIM, Plastic w/Seal
 Hole: M8.5, Upper head: 13MM,
 Trim Thk: 2.5MM, O/L: 20MM,
 P.R.: 0.7-1.4MM
 Toyota Cars & Trucks '98-2004
 Acura 2005/ & Honda 2004/
UNIT PACKAGE 25

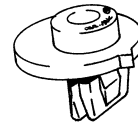
**99-8137**

Replaces: 90107-SX0-003
GROMMET - FRONT BUMPER
 Plastic
 Hole: 7x1 1.5MM Slot, Screw: M4.2 (#8)
 Honda Accord, Odyssey, Prelude, S2000,
 & Acura CL, TL, RL '95/
UNIT PACKAGE 10

**99-8220**

Replaces: 91512-SR3-004
NUT - TUBULAR, EMBLEMS
 Plastic w/seal and Closed End
 Hole: M6, Flange: 8.5MM, Stud: 3MM
 Acura & Integra '94/
 Honda Accord, Civic, Prelude & CR-V'94/
UNIT PACKAGE 10

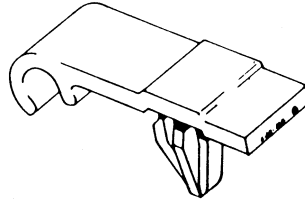
**92-7028**

Replaces: 91512-SE0-003
CLIP- WINDSHIELD WASHER HOSE
 Plastic
 Honda '88/
 Accura Legend '91/
UNIT PACKAGE 10

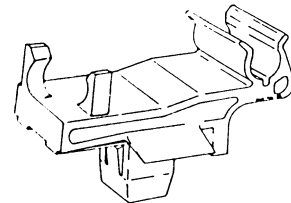
**91-6977**

Replaces: 91501-SD2-003
CLIP-HOOD PROP ROD
 Plastic
 Acura Integra '86-'90
UNIT PACKAGE 5

**96-7563**

Replaces: 10262143
RETAINER-COWL & INSULATOR
 Fits M5 Stud
 Washer Dia.: 20MM 10MM A/F
 Black Plastic
 G.M. "W" Bodies '96/, Honda & Acura
UNIT PACKAGE 25

SEE
www.carpak.com
FOR UPDATED
O.E. CROSS-REFERENCES

HONDA

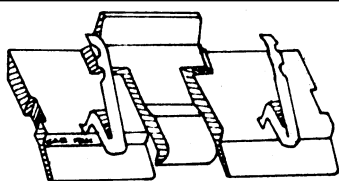
**81-5422**

Replaces: 90674-692-0030
CLIP-WINDSHIELD REVEAL MOULDING
 Self Adhesive, Plastic
 Honda Prelude '79 - '82
 Honda Accord '82 - '83
UNIT PACKAGE 25

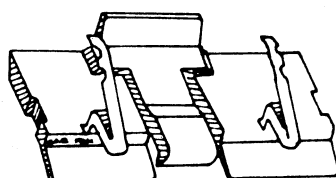
**82-5572**

Replaces: 90674-SA6-003
CLIP-WINDSHIELD REVEAL MOULDING
 Plastic
 Honda '79-'83
UNIT PACKAGE 25

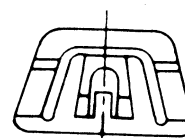
**81-5374**

Replaces: MB-106520,
 90694-SA6-003
CLIP-WINDSHIELD MOULDING
 Honda Accord '82-'83
 Chrysler Arrow, Colt
 Other Japanese Models
UNIT PACKAGE 25

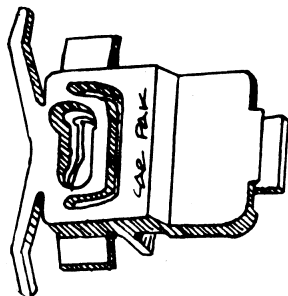
**81-5409**

Replaces: 90664-692-0300
CLIP-WINDSHIELD REVEAL MOULDING
 Honda Prelude '79/
UNIT PACKAGE 25

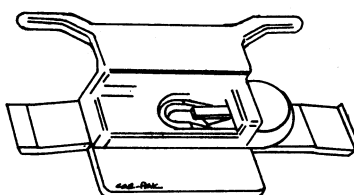
**84-5807**

Replaces: 90677-SA6-003
CLIP-FRONT WINDSHIELD
PILLAR MOULDING
 Plastic
 Honda Accord '84/
UNIT PACKAGE 25

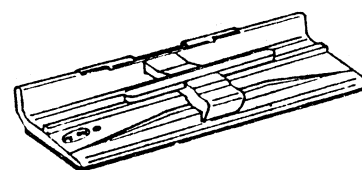
**85-5978**

Replaces: 90683-SC6-003
 & 90683-SA6-003
CLIP-WINDSHIELD MOULDING
 Dark Gray Plastic
 Overall Length 60MM
 Honda Accord '85/
UNIT PACKAGE 10

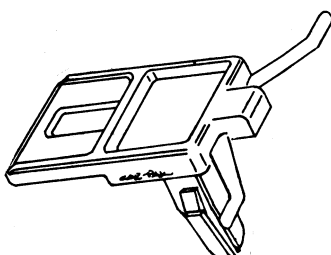
**84-5808**

Replaces: 74806-SB6-003
CLIP-BACK GLASS MOULDING
 Plastic
 Honda Civic '84/, Hatchback
UNIT PACKAGE 25

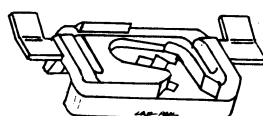
**84-5777**

Replaces: 90694-SB0-0030
CLIP-WINDSHIELD MOULDING
 Plastic
 Honda Prelude '83/
UNIT PACKAGE 25

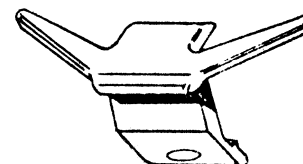
**84-5836**

Replaces: 90655-SB0-004
CLIP-WINDSHIELD MOULDING
 Gray Plastic
 Honda '83/
UNIT PACKAGE 25

**84-5835**

Replaces: 74807-SB0-004
CLIP-WINDSHIELD MOULDING REAR
 Black Plastic
 Honda '83/
UNIT PACKAGE 25

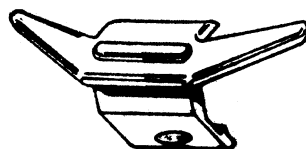
**84-5837**

Replaces: 90664-SB0-004
CLIP-WINDSHIELD MOULDING
 Black Plastic
 Honda '83/
UNIT PACKAGE 25

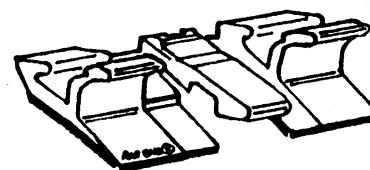
**86-6039**

Replaces: 90658-SB0-003
CLIP-REVEAL MOULDING QUARTER
WINDOW
 Self Adhesive Plastic
 Honda Prelude '83/
UNIT PACKAGE 10

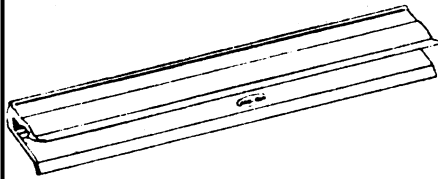
**84-5834**

Replaces: 74811-SB0-004
CLIP-WINDSHIELD MOULDING
 Front & Rear Self Adhesive Back
 Honda '83/
UNIT PACKAGE 10

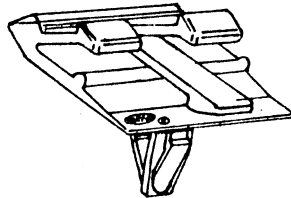
**84-5871**

Replaces: 90713-SB0-003
CLIP-QUARTER WINDOW MOULDING
 Lower
 Plastic
 Honda Prelude '83/
UNIT PACKAGE 25

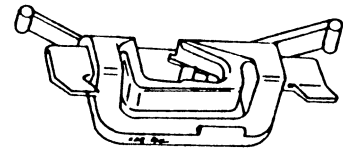
**88-6401**

Replaces: 90675-SC5-003
CLIP-WINDSHIELD MOULDING
 Gray Plastic
 Acura Legend 2 Door '86-'90
 Honda Accord '86-'89
UNIT PACKAGE 10

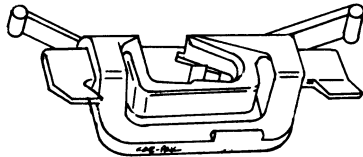
**84-5809**

Replaces: 90674-SC6-003
CLIP-BACK GLASS MOULDING
 Plastic
 Honda Accord '84/
UNIT PACKAGE 25

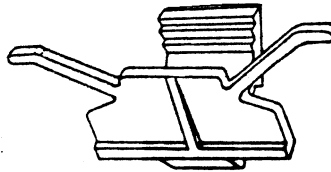
**84-5804**

Replaces: 90673-SC6-003
CLIP-WINDSHIELD MOULDING
 White Plastic
 Honda Accord '84
UNIT PACKAGE 25

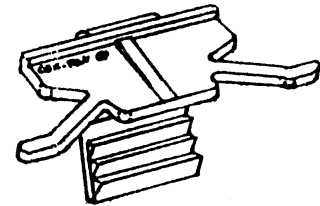
**85-6007**

Replaces: 90672-SA6-003
 & 90672-SC6-003
CLIP-WINDSHIELD MOULDING
 Black Plastic
 Honda Accord '84/
UNIT PACKAGE 25

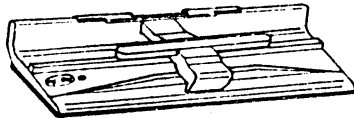
**85-5960**

Replaces: 90682-SC6-003
CLIP-WINDSHIELD MOULDING
 Self Adhesive
 Black Plastic
 Overall Length 48MM
 Honda Accord '84/
UNIT PACKAGE 10

**87-6323**

Replaces: 73262-SE3-003
CLIP-BACK GLASS MOULDING
 Self Adhesive Plastic
 Honda Accord 4 Door '86/
UNIT PACKAGE 10

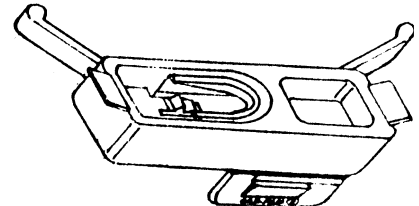
**86-6035**

Replaces: 73265-SE3-003
CLIP-WINDOW MOULDING UPPER
 Plastic
 Honda Accord 4 Door '86/
UNIT PACKAGE 25

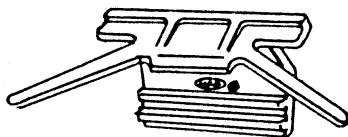
**87-6321**

Replaces: 73261-SE3-003
CLIP-BACK GLASS MOULDING
 Black Plastic
 Honda Accord 3 & 4 Door '86/
UNIT PACKAGE 25

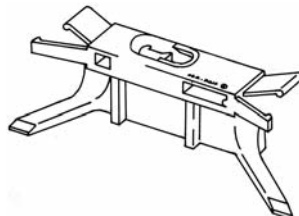
**99-8789**

Replaces: 91572-SDA-A01
**RETAINER-WINDSHIELD
 & ROOF DRIP MOULDING**
 Plastic-White
 Honda Accord, Pilot & Acura TL 2003/
UNIT PACKAGE 10

**99-8780**

Replaces: 91570-SDA-A01
**RETAINER-WINDSHIELD
 & ROOF DRIP MOULDING**
 Plastic-Blue
 Honda Accord, Pilot & Acura TL 2003/
UNIT PACKAGE 10

**99-8781**

Replaces: 91571-SDA-A01
**RETAINER-WINDSHIELD
 & ROOF DRIP MOULDING**
 Plastic-White
 Honda Accord & Acura TL 2003/
UNIT PACKAGE 10

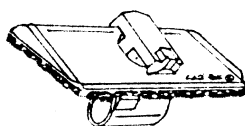
**89-6568**

Replaces: 90672-SE3-003
**CLIP-DOOR WINDSHIELD
 MOULDING (UPPER)**
 Plastic w/Sealer
 Honda Accord '86/
UNIT PACKAGE 15

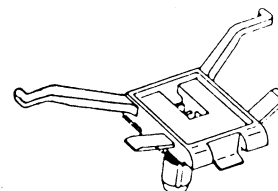
**89-6622**

Replaces: 61214-SF1-003
CLIP-WINDSHIELD MOULDING LOWER
 Plastic
 Honda Prelude '88/
UNIT PACKAGE 10

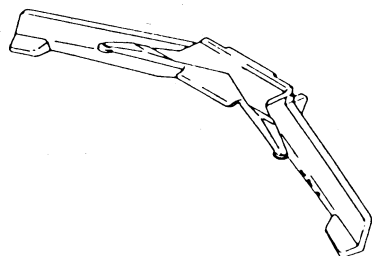
**90-6809**

Replaces: 90657-SF1-003
CLIP-BACK GLASS MOULDING
 Plastic
 Honda Prelude '88 - '89
UNIT PACKAGE 10

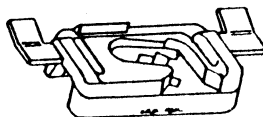
**88-6403**

Replaces: 91505-SG0-003
CLIP-WINDSHIELD MOULDING
 Orange Plastic
 Acura Legend 4 Door '88/
 Honda Prelude '88/
UNIT PACKAGE 10

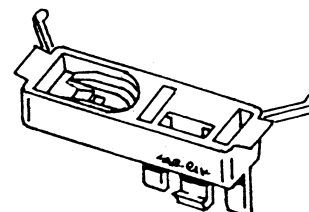
**89-6646**

Replaces: 73265-SG0-003
CLIP-BACK GLASS MOULDING UPPER
 Plastic
 Honda Accord 4 Door '88/
UNIT PACKAGE 25

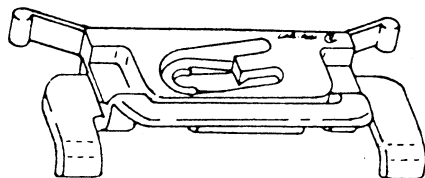
**90-6735**

Replaces: 91534-SM4-003
CLIP-WINDSHIELD MOULDING UPPER
 White Plastic
 Honda Accord '90/
 Acura Legend '91/
UNIT PACKAGE 15

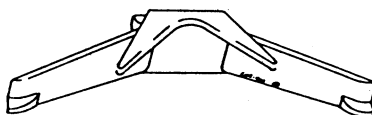
**91-6916**

Replaces: 91530-SM4-003
CLIP - REAR GLASS SIDE MOULDING
 Plastic
 Honda Accord 2 Door '90/
UNIT PACKAGE 10

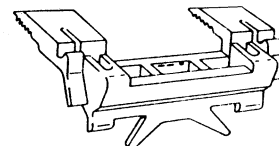
**91-6889**

Replaces: 91524-SM4-A11
CLIP-WINDSHIELD MOULDING SIDE
 Plastic
 (Use w/99-8046)
 Honda Accord '90/
UNIT PACKAGE 15

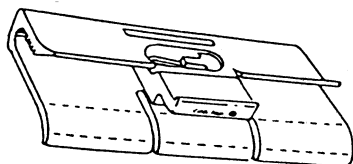
**99-8046**

Replaces: 91525-SM4-003
CLIP-WINDSHIELD MOULDING SIDE
 Pink Plastic
 (Use w/91-6889)
 Honda Accord '90/
UNIT PACKAGE 10

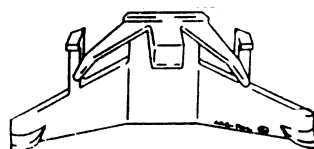
**95-7487**

Replaces: 73158-SM4-003
CLIP-WINDSHIELD SIDE FRONT
 Red Plastic
 Honda Accord 4 Door & SW '90 -'93
UNIT PACKAGE 10

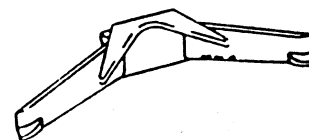
**95-7488**

Replaces: 91531-SM4-003
CLIP-WINDSHIELD UPPER FRONT
 Yellow Plastic
 Honda Accord 4 Door & SW '90 - '93
UNIT PACKAGE 10

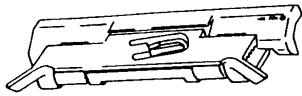
**98-7771**

Replaces: 91541-SM4-003
91542-SP0-003

CLIP- BACK GLASS SIDE MOULDING
Plastic-Blue (Adjustable)
Formerly 90-6751
Honda Accord '90/
UNIT PACKAGE 10

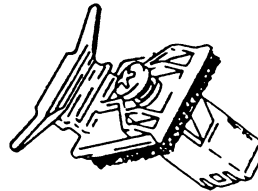
**92-7094**

Replaces: 91526-SM2-004
HOLDER-REAR WINDOW
w/SCREW & SEALER
Grey Plastic
Honda Accord Coupe '90/
UNIT PACKAGE 5

92-7095

Replaces: 91526-SM4-004
HOLDER-REAR WINDOW
w/SCREW & SEALER
Black Plastic
Honda Accord 4 Door '90
UNIT PACKAGE 5

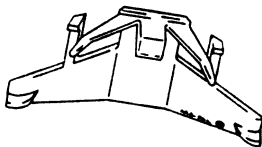
**95-7489**

Replaces: 91532-SM4-003
CLIP-FRONT WINDSHIELD SIDE
Grey Plastic
Honda Accord 4 Door & SW '90/ '93
UNIT PACKAGE 50

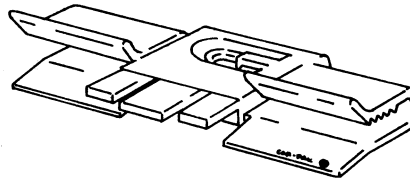
**96-7535**

Replaces: 91511-SR2-004
CLIP-WINDSHIELD MOULDING
FRONT SIDE
Yellow Plastic
Honda Civic '93/
UNIT PACKAGE 5

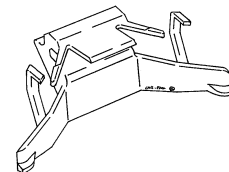
**97-7738**

Replaces: 91519-SR3-003
CLIP-WINDSHIELD MOULDING SIDE
Plastic-Green
Honda Civic 2, 3 & 4 Dr '92/'95
UNIT PACKAGE 10

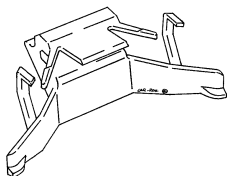
**97-7739**

Replaces: 91521-SR3-003
CLIP-WINDSHIELD MOULDING SIDE
Plastic-Purple
Honda Civic 2, 3 & 4 Dr. '92/'95
UNIT PACKAGE 10

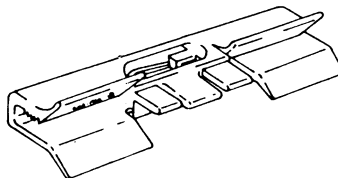
**92-7003**

Replaces: 91511-SR3-003
CLIP-WINDSHIELD MOULDING SIDE
Orange Plastic (Use w/92-7004)
Honda Civic '92/
UNIT PACKAGE 15

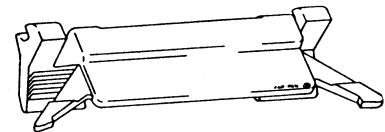
**92-7004**

Replaces: 91520-SR3-003
CLIP-WINDSHIELD MOULDING SIDE
Red Plastic (Use w/92-7003)
Honda Civic '92
UNIT PACKAGE 15

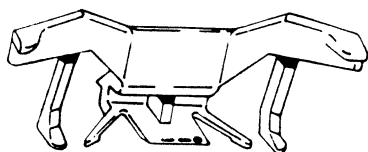
**93-7149**

Replaces: 91518-SR4-003
CLIP-WINDSHIELD MOULDING SIDE
Grey Plastic
Honda Civic '92/
UNIT PACKAGE 10

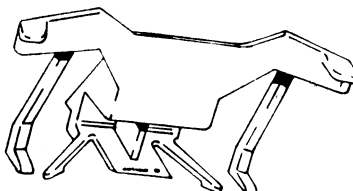
**93-7150**

Replaces: 91519-SR4-003
CLIP-WINDSHIELD MOULDING SIDE
Blue Plastic
Honda Civic '92/
UNIT PACKAGE 10

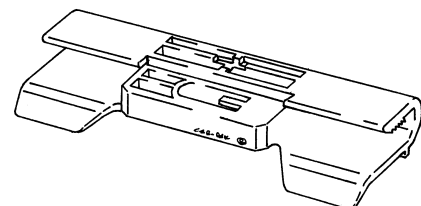
**99-8446**

Replaces: 91519-S5A-003
CLIP-WINDSHIELD MOULDING,
UPPER SIDE
Plastic
Honda Civic & Hybrid 2001/
UNIT PACKAGE 15

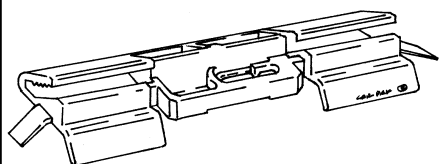
**99-8367**

Replaces: 91519-S5P-A01
RETAINER - WINDSHIELD SIDE MOLDING
 Plastic
 Honda Civic 2001/
UNIT PACKAGE 10

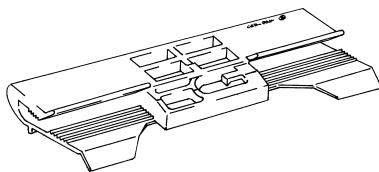
**99-8369**

Replaces: 91520-S5A-003
RETAINER - WINDSHIELD SIDE MOLDING
 Plastic
 Honda Civic 2001/ & Acura 1.7EL 2001
UNIT PACKAGE 25

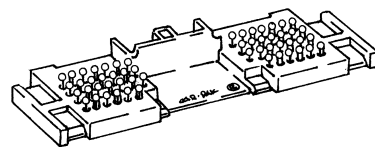
**99-8370**

Replaces: 91569-SZ3-013
RETAINER - BACK GLASS UPPER MOLDING
 Plastic (Adhesive)
 Honda Civic, Insight, Prelude '97/
 Acura 2.5TL, 3.2TL '95-'98
UNIT PACKAGE 5

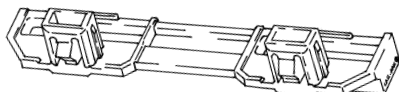
**99-8371**

Replaces: 91567-S3M-A01
RETAINER - WINDSHIELD UPPER MOLDING
 Plastic
 Use w/99-8372
 Honda Civic 2001 / & Acura 3.2CL,
 3.2TL '99/
UNIT PACKAGE 25

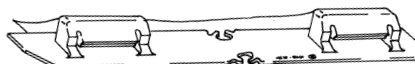
**99-8372**

Replaces: 91568-S3M-A01
RETAINER - WINDSHIELD UPPER MOLDING
 Plastic
 Use w/99-8371
 Honda Civic 2001/ & Acura 3.2CL, 3.2TL,
 MDX '99/
UNIT PACKAGE 5

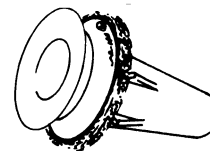
**94-7212**

Replaces: 90675-SR4-003
GROMMET-PIN RETAINER w/SEALER
 REAR WINDOW LOWER MOLDING
 Plastic
 Hole: M7 (Used w/94-7213)
 Honda Accord '94, Civic '92/
UNIT PACKAGE 10

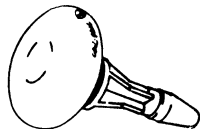
**94-7213**

Replaces: 90676-SR4-003
PIN RETAINER-REAR WINDOW LOWER MOLDING
 (Used w/94-7212 Grommet)
 Plastic
 Head: 12MM
 Honda Accord '94, Civic '92/
UNIT PACKAGE 15

**94-7294**

Replaces: 91525-SS0-003
CLIP-WINDSHIELD SIDE
 White Plastic
 Honda Prelude '92 - '94
UNIT PACKAGE 15

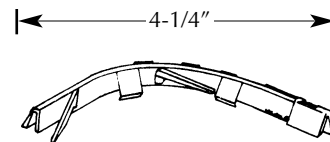
**94-7295**

Replaces: 73155-SS0-004
CLIP- WINDSHIELD R/H CORNER
 Black Plastic
 Honda Prelude '92 - '94
UNIT PACKAGE 5

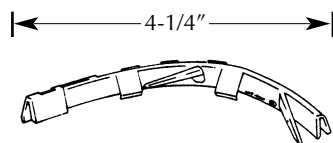
**94-7296**

Replaces: 73156-SS0-004
CLIP-WINDSHIELD L/H CORNER
 Black Plastic
 Honda Prelude '92 - '94
UNIT PACKAGE 5

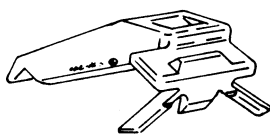
**93-7210**

Replaces: 91577-SV4-003
CLIP-WINDSHIELD MOLDING
 L/H Corner
 Red Plastic
 Honda Accord '94
UNIT PACKAGE 5

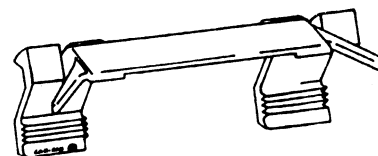
**96-7536**

Replaces: 91572-SV2-003
CLIP-WINDSHIELD MOLDING
 FRONT SIDE
 White Plastic
 Honda Accord '94/
UNIT PACKAGE 10

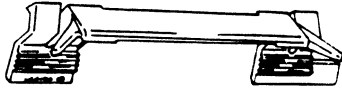
**93-7205**

Replaces: 91572-SV4-003
CLIP-WINDSHIELD MOULDING SIDE
 Pink Plastic (Use w/92-7006)
 Honda Accord '94/
UNIT PACKAGE 10

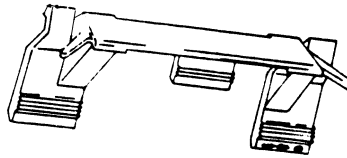
**93-7206**

Replaces: 91573-SV4-003
CLIP-WINDSHIELD MOULDING SIDE
 Blue Plastic (Use w/92-7005)
 Honda Accord '94/
UNIT PACKAGE 10

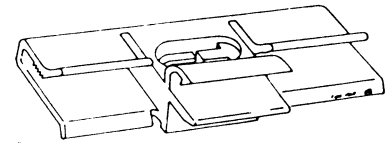
**92-7008**

Replaces: 91528-SP0-003
CLIP-WINDSHIELD MOULDING SIDE
 Yellow Plastic
 (use w/92-7009 or 93-7206)
 Acura 2 & 4 Door '91-'99
 Honda Accord '94-'98
UNIT PACKAGE 15

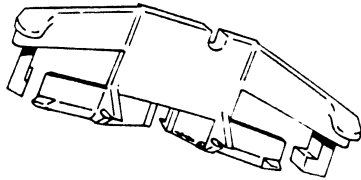
**93-7207**

Replaces: 91562-SV4-003
CLIP-WINDSHIELD MOULDING SIDE
 Yellow Plastic
 Honda Accord '94/
UNIT PACKAGE 5

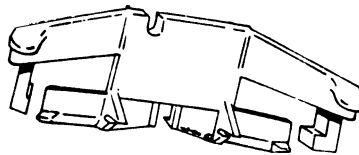
**93-7208**

Replaces: 91574-SV4-003
CLIP-WINDSHIELD MOULDING SIDE
 White Plastic
 Honda Accord '94/
UNIT PACKAGE 5

**99-8628**

Replaces: 75305-S0A-003
RETAINER-SIDE MOULDING
 Plastic-White
 Acura TL & RL '96-2004
 Honda Civic, CR-V, Odyssey & Pilot '97/
UNIT PACKAGE 15

**99-8629**

Replaces: 75305-SH2-003
RETAINER-SIDE MOLDING
 Plastic-Blue
 Acura CL, TL RL & Legend '91/
 Honda Civic & CR-V '92/
UNIT PACKAGE 15

**99-8630**

Replaces: 75305-SH4-003
RETAINER-SIDE MOLDING
 Plastic-Red
 Acura TL '95-'98
 Honda Civic & CR-V '96/
UNIT PACKAGE 15

**99-8787**

Replaces: 75315-S9A-004,
 75315-STK-A01
RETAINER-EXT. DOOR MOULDING
 Plastic
 Hole: M10sq, Head: 12x15MM,
 O/L: 15MM, P.R.: 1.5MM,
 Trim Thk: 2.5MM
 Acura RDX 2007/, Honda CR-V 2002/
UNIT PACKAGE 25

**99-8788**

Replaces: 75316-S9A-004
RETAINER-EXT. DOOR MOULDING
 Plastic
 Hole: M10, Flange: 14x16MM,
 O/L: 14.5MM, P.R.: 1.5MM
 Honda CR-V 2002/
UNIT PACKAGE 25

**99-8424**

Replaces: 8763591, 7698976
CLIP-WINDSHIELD & BACKGLASS
 Reveal Mouldings
 G.M. Midsize & Compact Cars '68-'70
 Formerly 67-3093 & 70-3403
 Honda Accord '85/
UNIT PACKAGE 50

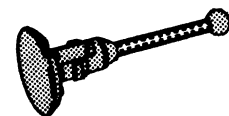
**87-6209**

Replaces: 90655-SB2-003
CLIP-PIN RETAINER VENT COWL &
INTERIOR TRIM PANELS
 Plastic
 Honda Civic '84/
UNIT PACKAGE 25

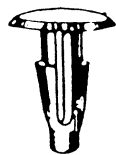
**89-6714**

Replaces: 90672-671-003
CLIP-COWL GRILLE & HEADLINER
 Hole: M5, Head: 12MM, P.R.: 5MM
 Gray Plastic
 Honda Accord '86/ & Acura Legend,
 2.5TL & 3.5 TL '91-'98
UNIT PACKAGE 25

**89-6672**

Replaces: 90687-SA5-003, 90467-08008
**CLIP-COWL TOP, WEATHERSTRIP,
 TRIM PANELS**
 Black Plastic
 Hole: M5, Head: 13MM,
 Stem Lgth: 15MM, P.R.: 4MM
 Honda Accord '87/ &
 Acura Vigor '92-'94, Toyota
UNIT PACKAGE 25

**99-8219**

Replaces: 91501-SL4-003
RETAINER - COWL VENT
 Plastic
 Hole: M6, Head: 13MM, P.R.: .5MM
 Acura 3.5 & Legend '91/
 Honda Civic 2001
UNIT PACKAGE 10

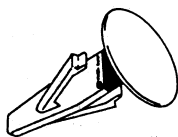
**91-6939**

Replaces: 91501-SM4-003
RETAINER-COWL TOP
 Head: 14MM
 Plastic
 Honda Accord '90/
UNIT PACKAGE 15

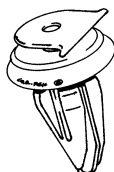
**99-8368**

Replaces: 90602-S5A-003
RETAINER - COWL VENT
 Plastic
 Hole: M9, Upper Hd: 12 x 13MM,
 O/L: 20MM, Trim Thk: 3MM
 Honda Civic, CR-V & Acura, RSX 2001/
UNIT PACKAGE 15

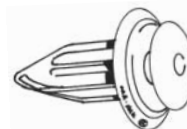
**99-8574**

Replaces: 90467-10188, 91560-S6A-003
**RETAINER-COWL, W/S GARNISH,
 INTERIOR TRIM, Plastic w/Seal**
 Hole: M8.5, Upper head: 13MM,
 Trim Thk: 2.5MM, O/L: 20MM,
 P.R.: 0.7-1.4MM
 Toyota Cars & Trucks '98-2004
 Acura 2005/ & Honda 2004/
UNIT PACKAGE 25

**99-8706**

Replaces: 90602-SLJ-003, 90603-SLJ-003
RETAINER-COWL VENT
 Plastic
 Slot: 7MM wide, Head: 10x14MM, O/L:
 18.5MM, P.R.: 2MM, Trim Thk: 2.8MM
 Acura RDX & Honda CR-V 2007/
UNIT PACKAGE 10

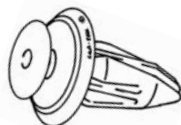
**99-8687**

Replaces: 90602-SAA-003
RETAINER-COWL VENT
 Plastic
 Hole: M8.5, Upper Hd: 12MM,
 Trim Thk: 3MM, O/L: 20.5MM
 Honda Fit 2007
UNIT PACKAGE 15

**86-6084**

Replaces: 90688-SB0-003
RIVET-SCREW TYPE
 AIR SCOOP GRILLE, COWL VENT PANEL
 Black Plastic
 Hole: M6, Flange: 18MM,
 P.R.: 2.0 - 6.0MM
 Honda Prelude '83/
UNIT PACKAGE 25

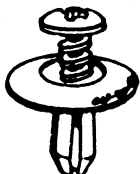
**86-6079**

Replaces: 90687-SB0-003, 90687-SB0-013
RIVET-SCREW TYPE
 AIR SCOOP GRILLE, COWL VENT PANEL
 Black Plastic
 Hole: M6, Flange: 13MM,
 P.R.: 2.0 - 6.0MM
 Honda Prelude '83/
UNIT PACKAGE 25

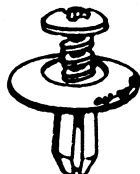
**90-6749**

Replaces: 91524-SE0-003
RIVET-SCREW TYPE COWL VENT
 Plastic
 Hole: M6, Flange: 17.5MM,
 P.R.: 5-7MM
 Honda Accord '86 - '89
 Acura Vigor '92
UNIT PACKAGE 25

**87-6211**

Replaces: 90675-SB0-003,
 FB01-56-964 & 63876-95596
RIVET-SCREW TYPE
 COWL VENT; FENDER SPLASH
 SHIELD & AIR DUCTS
 Black Plastic
 Hole: M8, Flange 20.0MM
 P.R.: 2.0-5.0MM,
 Honda, Mazda, Nissan '84/
UNIT PACKAGE 10

**95-7463**

Replaces: 90657-SA6-003, 90467-07072,
N304-13-356-B
RIVET-SCREW TYPE, COWL GRILLE
Hole: M7, Washer Head: 14MM
Length: 11MM
Honda Accord '90 - '91, Mazda & Toyota
UNIT PACKAGE 25

**95-7462**

Replaces: 91545-SE0-003
& 63848-01G00-A
RIVET-DRIVE TYPE, COWL GRILLE
Hole: M8, Washer Head: 20MM
Length: 14MM
Honda Accord '90/, Nissan Trucks '87/
Mercury Villager
Maxima thru '98
UNIT PACKAGE 15

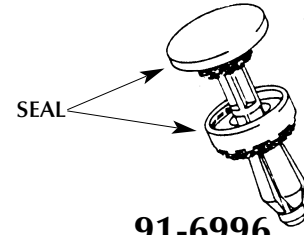
**91-6996**

Replaces: 91508-SM4-003
RETAINER-COWL GRILLE
Plastic
Hole: M8 Head Dia.: 17MM,
Stem Lgth: 10MM
Honda Accord '90/ & Acura 3.5RL '96-'02
UNIT PACKAGE 10

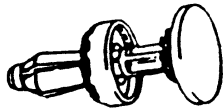
**96-7529**

Replaces: 91508-SR3-000
RETAINER- COWL GRILLE
Hole: M7
Head: 17.5MM, Stem Lgth: 9MM,
P.R.: 0.80MM
Panel Thickness: .80MM
Black Plastic
Honda Civic '92, CRV '97/ &
Acura Integra '94-2001
UNIT PACKAGE 10

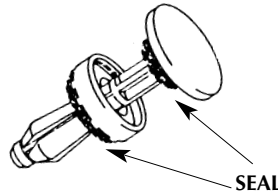
**99-8045**

Replaces: 91508-S50-003
RETAINER-COWL GRILLE
Plastic
Hole: 7X9MM Oval, Head: 17.5MM
Stem Lgth: 13.5MM
Honda Accord & Odyssey '98/
UNIT PACKAGE 5

**99-8221**

Replaces: 90602-SX0-003
RETAINER - COWL VENT
Plastic
Hole: M4.2, O/L: 18MM,
Upper Head: 12MM, Stem Lgth: 12.5MM,
Trim Thk: 2.7MM
Acura MDX, Honda Civic, Insight,
Odyssey & Prelude '95/
UNIT PACKAGE 10

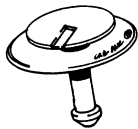
**99-8441**

Replaces: 90602-S7S-003
RETAINER-COWL VENT
Plastic, Blue Use w/99-8442
Upper Hd: 12MM, Lwr Hd: 16MM,
O/L: 11.5MM
Honda Accord 2003
UNIT PACKAGE 25

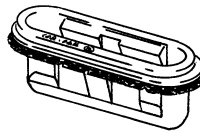
**99-8442**

Replaces: 90603-S7S-003
GROMMET-COWL VENT
Plastic, Blue W/Seal, Use w/99-8441
Hole: 6x20MM, Flange: 10x24MM,
P.R.: 1MM
Honda Accord 2003
UNIT PACKAGE 15

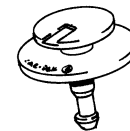
**99-8479**

Replaces: 90602-S2A-003
RETAINER-COWL VENT
Plastic-Yellow
use w/99-8480 Grommet
Upper Head: 12MM, Trim Thk: 2.6MM
Honda Civic, Element & Insight 2000/
UNIT PACKAGE 25

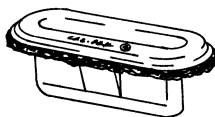
**99-8480**

Replaces: 90603-S2A-003
GROMMET-COWL VENT
Plastic-Yellow, w/Seal
use w/99-8479 Retainer
Hole: 6x20MM Slot, Flange: 10x24MM,
P.R.: 0.65-0.90
Honda Civic, Element & Insight 2000/
UNIT PACKAGE 15

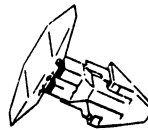
**95-7494**

Replaces: 91515-SR3-000
CLIP-WEATHER STRIP RET.
Cowl
Black Plastic
Hole: M6, Head: 8MM x 17.8MM
Honda Civic '93/, CR-V '97/ &
Acura Integra '94-2001
UNIT PACKAGE 25

**88-6431**

Replaces: 60658-SB3-000
COVER-COWL SCREEN SCREW
Black Plastic
Honda Civic '84/
UNIT PACKAGE 15

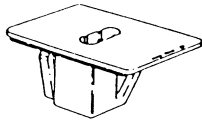
**90-6768**

Replaces: 60642-SB3-003
GROMMET NUT
 COWL SCREEN
 M4 Screw
 Plastic w/Sealer
 Honda Civic '84 - '87
UNIT PACKAGE 10

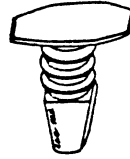
**82-5506**

Replaces: 90664-671-003,
 91530-SH4-003
CLIP-WEATHERSTRIP
 Plastic-White
 Hole: M5, Head: 6.6x16MM, O/L: 14MM
 Nissan, Honda
UNIT PACKAGE 50

**81-5332**

CLIP-WEATHERSTRIP
 Honda
UNIT PACKAGE 100

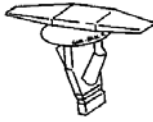
**97-7705**

Replaces: 91530-SPL-003
RETAINER-WEATHERSTRIP
 Plastic
 Hole: M6, O/L: 11.5MM,
 Head: 5MM X 15MM
 Honda Accord, Civic & Odyssey '92/
UNIT PACKAGE 50

**97-7720**

Replaces: 91530-ST5-003
**CLIP-WEATHERSTRIP FRT
 & REAR DOOR**
 Plastic
 Hole: M6, Stem Lgth: 8MM
 Honda Civic '95/ & Element 2003/
UNIT PACKAGE 10

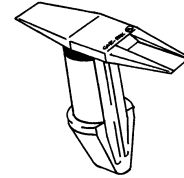
**99-8053**

Replaces: 91502-S84-A11
RETAINER-WEATHERSTRIP
 REAR HOOD SEAL
 Hole: M6, Head: 6.5X16.5MM, P.R.:7MM
 Honda Accord & Odyssey '98/ & Element
UNIT PACKAGE 15

**96-7607**

Replaces: 91520-SM4-C01
CLIP- HOOD-SEAL
 Plastic-Black
 Hole Dia: M5, Head Dia: 10MM
 O/L: 14.4MM
 Honda, Acura '90/
UNIT PACKAGE 25

**97-7719**

Replaces: 91518-SM4-003
RETAINER-HOOD SEAL
 Plastic
 Hole: M7, Head Dia: 12MM, Stem Lgth:
 9MM
 Honda, Civic 3 Dr, 4 Dr. & Coupe, Acura,
 Integra '94/
UNIT PACKAGE 15

**99-8525**

Replaces: 91518-S10-003
RETAINER-HOOD SEAL
 Plastic
 Hole: M5, Head: 11MM,
 P.R.: 3.5MM, O/L: 9.5MM
 Honda Accord & Odyssey '99/
UNIT PACKAGE 25

**96-7509**

Replaces: 90700-SJ4-000
CLIP-HOOD INSULATION
 Black Plastic
 Hole M7.5, Head Dia..30
 Panel Range 1.5-5.0mm
 Honda Odyssey '95/, Acura '91/
UNIT PACKAGE 15

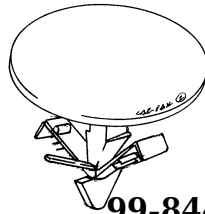
**99-8443**

Replaces: 91501-S1K-003, 91501-STK-003
RETAINER-HOOD INSULATOR
 Plastic
 Hole: M7, Head: 30MM,
 Stem Lgth: 14MM, O/L: 15.5MM
 Honda: Accord, Civic, CR-V, S2000 2000/
 Acura 3.5RL & RSX 2002/, Fit 2007/
UNIT PACKAGE 25

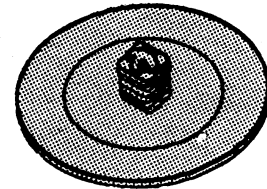
**87-6322**

Replaces: 90700-SB2-003
CLIP-HOOD INSULATION
 Plastic
 Hole: M6, Head Dia.: 30MM
 Panel Range: 1.5-5.0MM
 Honda Prelude '85/
UNIT PACKAGE 15

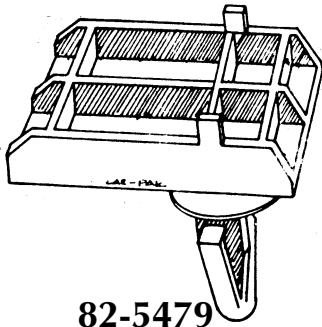
**82-5479**

Replaces: 90660-689-771
CLIP-BODY SIDE MOULDING
 Honda Accord
UNIT PACKAGE 25

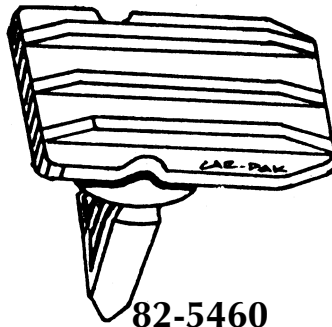
**82-5460**

Replaces: 90661-689-771
CLIP-BODY SIDE MOULDING
 Honda Accord
UNIT PACKAGE 25

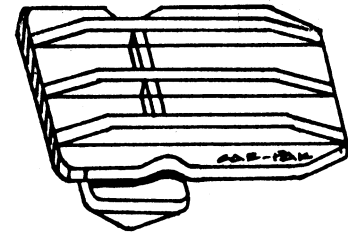
**82-5478**

Replaces: 90662-689-771
CLIP-BODY SIDE MOULDING
 Honda Accord
UNIT PACKAGE 25

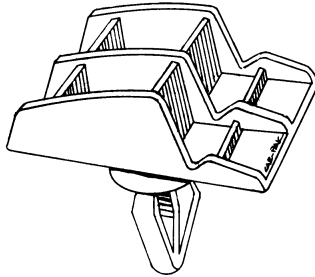
**83-5702**

Replaces: 90661-SA5-6720
CLIP-BODY SIDE MOULDING
 Honda Accord '80/
UNIT PACKAGE 25

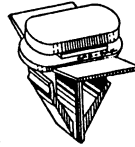
**83-5703**

Replaces: 90675-692-0031
CLIP-BODY MOULDING
 Honda '79 - '83
 Prelude & Other Models
UNIT PACKAGE 25

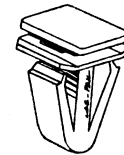
**83-5704**

Replaces: 90679-692-0030
CLIP- BODY SIDE MOULDING
 Honda '79 - '83
 Prelude & Other Models
UNIT PACKAGE 25

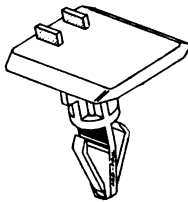
**84-5776**

Replaces: 90662-692-003
CLIP-BODY SIDE MOULDING
 Plastic
 Honda Prelude '79 - '82
UNIT PACKAGE 25

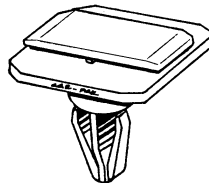
**83-5691**

Replaces: 90660-671-0030
CLIP-BODY SIDE MOULDING
 Honda Accord
UNIT PACKAGE 25

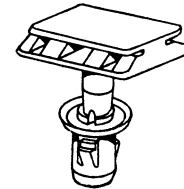
**84-5806**

Replaces: 90673-SC5-003
CLIP-ASSY. SIDE APRON MOULDING
 RETAINER BUSHING & CLIP
 Plastic
 Honda Accord '84/
UNIT PACKAGE 25

**88-6487**

Replaces: 91534-SE0-000
CLIP- BODY SIDE MOULDING
 Plastic
 Honda Accord '86/
UNIT PACKAGE 25

**91-6921**

Replaces: 75329-SH4-013
CLIP- DOOR MOULDING
 Red Plastic
 Honda Accord '90
UNIT PACKAGE 15

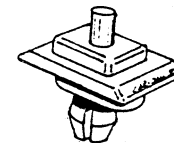
**88-6478**

Replaces: 90853-671-003
RIVET-DRIVE TYPE w/SHOULDER
 FRONT LOWER SPOILER
 Hole: M8 Rect., Shoulder: 12MM x 18MM
 Panel Range: 2-6MM
 Honda Accord '79 - '81
UNIT PACKAGE 15

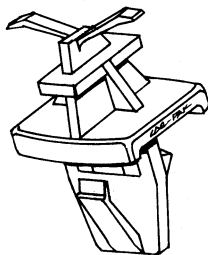
**84-5775**

Replaces: 90652-692-003
CLIP-GRILLE LOWER MouldING
 Plastic
 Honda Prelude '79 - '82
UNIT PACKAGE 25

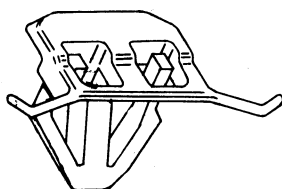
**84-5784**

Replaces: 90642-SA5-003
CLIP- DOOR REVEAL MouldING
 Plastic
 Honda Accord '82/
UNIT PACKAGE 25

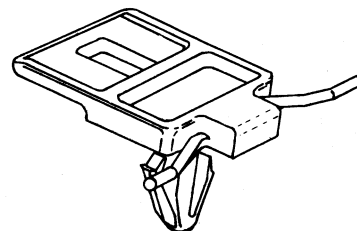
**84-5786**

Replaces: 90664-SA5-003
**CLIP-REAR UPPER CENTER APRON
 to BUMPER**
 Honda Accord '82 - '83
UNIT PACKAGE 25

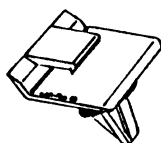
**85-5980**

Replaces: 90656-SB0-013
**CLIP-QUARTER PANEL
 MouldING, UPPER**
 Plastic
 Honda Prelude '83/
UNIT PACKAGE 25

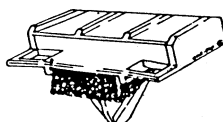
**90-6769**

Replaces: 90605-SF1-003
**CLIP-PILLAR GARNISH
 MouldING REAR**
 Plastic
 Honda Prelude '88/
UNIT PACKAGE 10

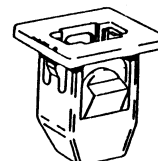
**90-6865**

Replaces: 91510-SH2-000
CLIP-DOOR BODY SIDE MouldING
 Plastic
 Honda CRX '88/
UNIT PACKAGE 10

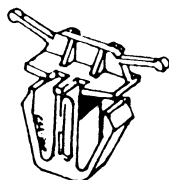
**90-6722**

Replaces: 90660-SA6-003
CLIP-LOWER GRILLE MouldING
 Black Plastic
 Honda Accord 4 Door '84 - '85
UNIT PACKAGE 25

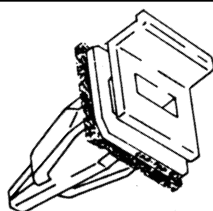
**91-6992**

Replaces: 91513-SM4-000
**RETAINER-ROCKER PANEL MouldING
 w/SEALING WASHER**
 Plastic
 Honda Accord '90/, Civic '92 &
 Element 2003/
UNIT PACKAGE 15

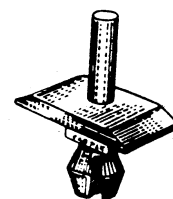
**84-5774**

Replaces: 90678-SA0-003
CLIP- FRONT AIR SPOILER TO BODY
 Plastic
 Honda Civic 1500 '80 - '81
 Station Wagon '80 - '83
UNIT PACKAGE 25

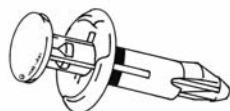
**99-8681**

Replaces: 90505-SX0-003
RIVET-DRIVE TYPE, SIDE MouldING
 Plastic-Matte & Textured
 Hole: M8, Flange: 18MM,
 Stem Lgth.: 15MM, P.R.: 9-11MM
 Honda CR-v & Odyssey '95/
UNIT PACKAGE 10

**99-8601**

Replaces: 91505-ST7-003ZA
RIVET-DRIVE TYPE, DOOR PANEL
 Plastic-Textured
 Hole: M8, Flange: 17MM,
 Stem Lgth: 12MM, P.R.: 3-8MM
 Honda CR-V & S2000 2000/
UNIT PACKAGE 10

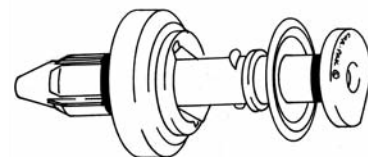
**99-8770**

Replaces: 91561-SJD-003
RETAINER-W/S GARNISH MouldING
 Plastic, White Pin/Black Grommet
 Hole: M8.5, Flange: 18MM, O/L: 37MM,
 Top Hd: 15MM, Trim Thk: 5MM
 Acura RL, Honda Civic, Fit & Pilot 2005/
UNIT PACKAGE 5

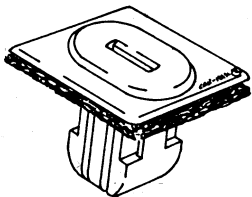
**91-6993**

Replaces: 91536-SM4-003
GROMMET NUT- w/SEALER
 ROOF DRIP RAIL
 Screw: M4, Hole: 10MM x 7MM
 Yellow Plastic
 Honda Accord '90/
UNIT PACKAGE 15

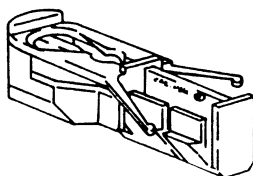
**95-7486**

Replaces: 90666-SS0-003
CLIP-ROOF MOULDING
 White Plastic
 Honda Prelude '92/
UNIT PACKAGE 10

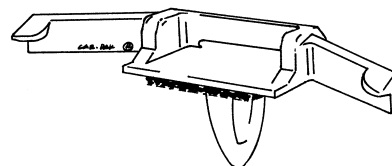
**96-7593**

Replaces: 91528-SR4-003, 91528-S01-A01
CLIP- DRIP-RAIL-WITH-SEAL
 Honda Accord '94/, Civic '92/
UNIT PACKAGE 15

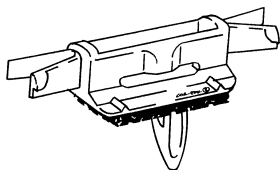
**99-7931**

Replaces: 91528-SM4-023
CLIP-DRIP RAIL
 White Plastic
 Honda Accord '90 - '93
UNIT PACKAGE 10

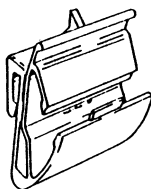
**89-6665**

Replaces: 90604-SH3-014
CLIP-DOOR BELT MOULDING
 Plastic
 Honda Civic '88/
UNIT PACKAGE 15

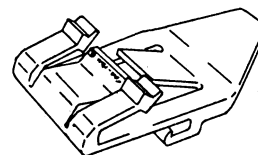
**91-6963**

Replaces: 91527-SM4-003
CLIP-BELT MOULDING
 Plastic- White
 Honda Accord '90/
UNIT PACKAGE 10

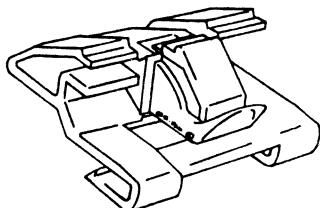
**96-7537**

Replaces: 91510-SR3-003
CLIP-DOOR MOULDING
 White Plastic
 Honda Civic '95/
UNIT PACKAGE 10

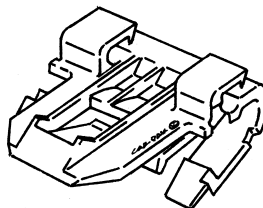
**98-7822**

Replaces: 91589-SV4-003
CLIP- BELT MOULDING
 Red Plastic
 Honda Accord 4 Door '94/
UNIT PACKAGE 25

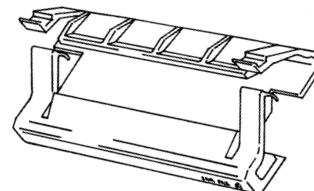
**98-7857**

Replaces: 91531-ST0-003
CLIP-BELT MOULDING
 Lime Green Plastic
 Honda Civic '96/
UNIT PACKAGE 15

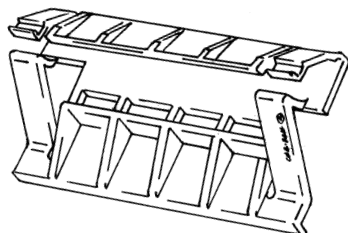
**99-8389**

Replaces: 91501-S5A-003
RETAINER-BELT MOULDING
 Plastic
 Honda Civic 2001/
UNIT PACKAGE 15

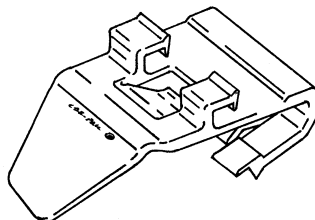
**98-7858**

Replaces: 91561-S84-A01
CLIP-BELT MOULDING
 Lt. Blue Plastic
 Honda Accord '98
UNIT PACKAGE 25

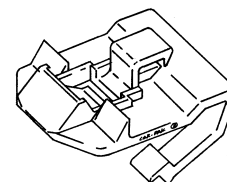
**98-7859**

Replaces: 91562-S84-A01
CLIP-BELT MOULDING
 Yellow Plastic
 Honda Accord '98
UNIT PACKAGE 10

**98-7823**

Replaces: 90676-671-003
& 90676-671-013
**CLIP- FRONT & REAR FENDER
SPLASH SHIELD**
Plastic
(Formerly 81-5394)
Honda
UNIT PACKAGE 15

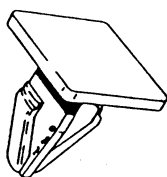
**90-6810**

Replaces: 90654-SE0-000
CLIP- BUMPER COVER
Plastic
Honda Accord '86 - '89
UNIT PACKAGE 50

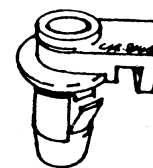
**90-6721**

Replaces: 90665-SA5-003
**RETAINER-REAR BUMPER
APRON MOULDING**
Black Plastic
Honda Accord 4 Door '84 - '85
UNIT PACKAGE 25

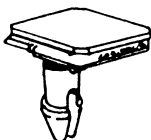
**90-6720**

Replaces: 90663-SA5-003
**CLIP-REAR BUMPER
APRON MOULDING**
White Plastic
Honda Accord 4 Door '84 - '85
UNIT PACKAGE 25

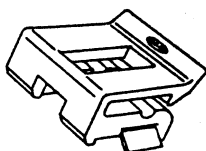
**88-6388**

Replaces: 91501-SB4-003
CLIP-REAR BUMPER APRON
Plastic
Honda Civic '86 - '87
UNIT PACKAGE 10

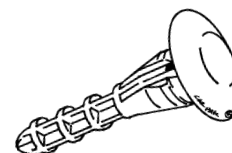
**98-7910**

Replaces: 90108-SW3-003
RETAINER-REAR BUMPER
Plastic
Hole: M6, Head: 16MM,
Stem Lgth: 22MM
Honda Accord, Prelude Odyssey '95/
UNIT PACKAGE 10

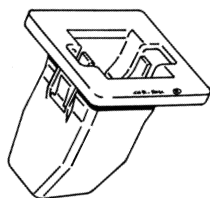
**99-7915**

Replaces: 90106-SW3-003
GROMMET-REAR BUMPER
Plastic
Screw: M6.3, Hole: M11 Sq.,
Flange: 18 x 20MM
Honda Accord, Prelude & Odyssey '95/
UNIT PACKAGE 15

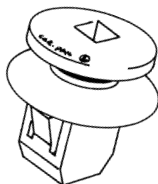
**99-8289**

Replaces: 91509-SM4-000
RETAINER - BUMPER COVER
Plastic
Hole: 10MM Square, Slot: 10 X 3.5MM
Honda Accord '90-'93
UNIT PACKAGE 10

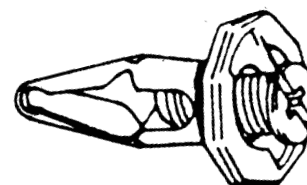
**90-6788**

Replaces: 91504-SM4-000
**RIVET-SCREW TYPE
BUMPER FASCIA FRT. & REAR**
Plastic
Hole: M10, Flange: 20MM, P.R.: 6-9MM
Honda Accord '90/, Acura Vigor Rear '92
UNIT PACKAGE 10

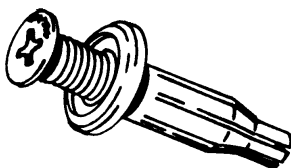
**94-7214**

Replaces: 91502-SP0-003, 94530624
RIVET- SCREW TYPE BUMPERS
Plastic
Hole: M10, Flange: 20MM,
P.R.: 5-12MM
Honda '92/, Accura '91/
Saturn Vue 2008
UNIT PACKAGE 5

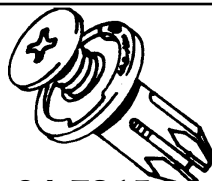
**94-7215**

Replaces: 91503-SP0-003, 94530623
**RIVET- SCREW TYPE,
BUMPERS & GRILLE**
Plastic
Hole: M10, Flange: 20MM
P.R.: 4-8MM
Honda '92/, Accura '91/
Chevrolet Aveo 2004/
UNIT PACKAGE 10

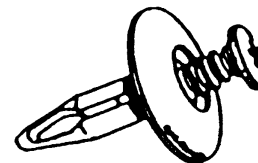
**90-6787**

Replaces: 91502-SM4-000
**RIVET-SCREW TYPE
BUMPER FASCIA FRONT & REAR**
Hole: M10, Washer Face: 20MM
P.R.: 6-9MM
Plastic
Honda Accord '90/
Accura Vigor Frt. '92
UNIT PACKAGE 15

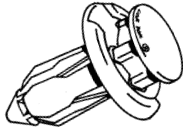
**98-7829**

Replaces: 91503-SZ3-003
RIVET- PIN DRIVE TYPE
 BUMPER & FRONT GRILLE
 Plastic
 Hole: M10, Flange: 20MM, P.R.: 5MM
 Honda Cars & Odyssey,
 Acura 3.5RL Sedan '96/
 Honda Element 2003/, Fit 2007/
UNIT PACKAGE 15

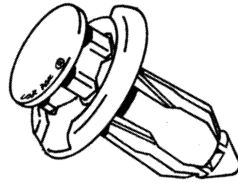
**98-7860**

Replaces: 91503-SZ5-003
RIVET-DRIVE TYPE
 FRONT & REAR BUMPER
 Plastic
 Hole: M10, Flange: 20MM, P.R.: 7MM
 Honda Accord '98/
UNIT PACKAGE 15

**99-8044**

Replaces: 90657-SB0-003
RIVET-DRIVE TYPE
 BUMPER COVERS & FENDER WELLS
 Hole: M6.3, Flange: 10.8MM, P.R.: 2.5MM
 Honda Accord, Prelude,
 Legend & Odyssey '83/
UNIT PACKAGE 10

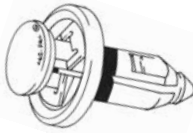
**99-8619**

Replaces: 91505-S9A-003
RIVET-DRIVE TYPE, FRONT BUMPER
 Plastic w/Metal Insert
 Hole: M10, Flange: 20MM,
 Stem Lgth: 13MM, P.R.: 6MM
 Honda Civic 2006 & Fit 2007
UNIT PACKAGE 10

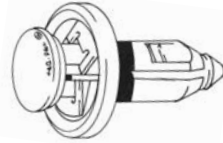
**99-8705**

Replaces: 91506-S9A-003
DRIVE RIVET-BUMPER, UPPER &
LOWER ENGINE COVER
 Plastic w/Metal Insert
 Hole: M10, Flange: 20MM,
 Stem Lgth: 16MM, P.R.: 8MM
 Acura MDX, RDX, TSX 2004/
 Honda Civic & CR-V 2006/
UNIT PACKAGE 10

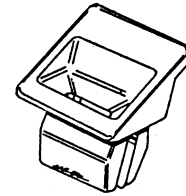
**84-5785**

Replaces: 90669-SA5-6720
SCREW ANCHOR-ADJUSTABLE
 GRILLE TO BODY
 Plastic
 Honda Accord '82/
UNIT PACKAGE 25

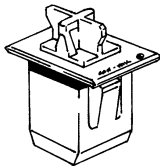
**99-8241**

Replaces: 90157-SPO-901
RETAINER-RADIATOR GRILLE
 Plastic
 Hole: M8 Sq., Flange: 10x14MM,
 Stem Lgth: 10MM
 Acura CL, TL, RL, & Legend '91/
 Honda Odyssey '95-'98
UNIT PACKAGE 10

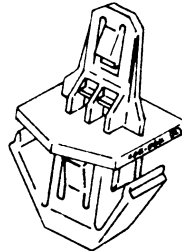
**94-7217**

Replaces: 91578-SV4-003
RETAINER-RADIATOR GRILLE
 Plastic
 Honda Accord '94
UNIT PACKAGE 5

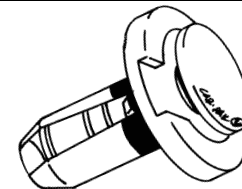
**99-8445**

Replaces: 91503-S0K-A01
RIVET-DRIVE TYPE
 Grille Mounting
 Plastic
 Hole: M10, Flange: 20MM,
 Stem Lgth: 14MM, P.R.: 4-8MM
 Honda Element 2003
UNIT PACKAGE 15

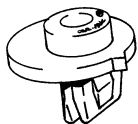
**99-8137**

Replaces: 90107-SX0-003
GROMMET - FRONT BUMPER
 Plastic
 Hole: 7x1 1.5MM Slot, Screw: M4.2 (#8)
 Honda Accord, Odyssey, Prelude, S2000,
 & Acura CL, TL, RL '95/
UNIT PACKAGE 10

**86-6034**

GROMMET NUT- FENDER
WHEELHOUSE MOULDING
 M4 Screw
 Plastic
 Honda Accord '86/
UNIT PACKAGE 25

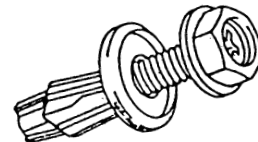
**91-6994**

Replaces: 91516-SK7-013, 01553-034U
RIVET-SCREW TYPE FRONT
SPLASH SHIELD, BUMPER
 Hex Drive w/Phillips Recess
 Plastic
 Hole: M8, Washer: 20MM, A/F: 10MM
 Honda Civic '92/ & Nissan Quest Extera,
 Frontier '99/
UNIT PACKAGE 10

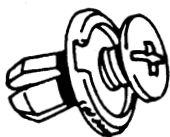
**91-6958**

Replaces: 91512-SM4-003

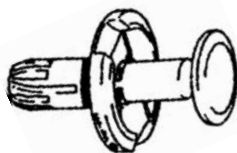
RIVET-SCREW TYPE
FENDER SPLASH SHIELD
PlasticHole: M8, Washer Face: 20MM
Grip Range: 3-5MM
Honda Accord '90/
UNIT PACKAGE 15**97-7718**

Replaces: 91501-S04-003

RIVET-PIN DRIVE, FRONT FENDER
PlasticHole: M8, Flange Dia: 20MM,
Grip Range: 4MM
Honda, Civic 2 Dr, 4 Dr & Del Sol '93/
UNIT PACKAGE 15**98-7862**

Replaces: 91512-SX0-003

RIVET-DRIVE TYPE
PlasticFront & Rear Fender Splash Shield
Hole: M8, Flange: 20MM, P.R.: 4MM
Honda Accord & Prelude, Acura '94/
UNIT PACKAGE 25**99-8601**

Replaces: 91505-ST7-003ZA

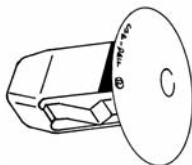
RIVET-DRIVE TYPE, DOOR PANEL
Plastic-TexturedHole: M8, Flange: 17MM,
Stem Lgth: 12MM, P.R.: 3-8MM
Honda CR-V & S2000 2000/
UNIT PACKAGE 10**99-8617**

Replaces: 90682-SEA-003

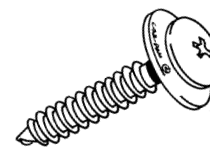
RETAINER-FENDER APRON
PlasticHole: 9MM Sq., Flange: 20MM,
O/L: 14MM, P.R.: 3.5MM
Honda Civic & Odyssey 2005/
Acura TSX 2004/
UNIT PACKAGE 25**99-7993**

Replaces: 90114-SE0-000

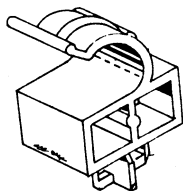
SCREW-TAPPING, PHILLIPS TRUSS HEAD
M4.8 x 19MM, w/15.5MM Sems Washer
Black FinishHonda 86/. & General Purpose
UNIT PACKAGE 25**84-5755**

Replaces: 90677-671-0031

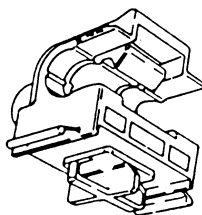
CLIP-HOOD PROP. RODHonda
UNIT PACKAGE 50**90-6805**

Replaces: 90677-SE0-003

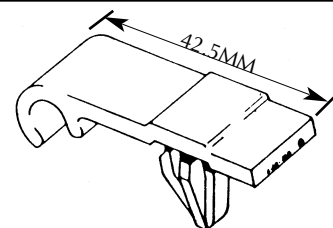
CLIP-HOOD PROP ROD
PlasticHonda Accord '86/
UNIT PACKAGE 5**92-7028**

Replaces: 91512-SE0-003

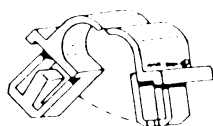
CLIP- WINDSHIELD WASHER HOSE
PlasticHole: M7
Honda '88/, Accura Legend '91/
UNIT PACKAGE 10**89-6657**

Replaces: 90652-SB2-023

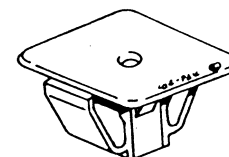
RETAINER-WINDSHIELD WASHER HOSE
3MM Hose, Hole: M7 Sq.
PlasticHonda '86/
UNIT PACKAGE 25**85-5991**Replaces: 90684-SA5-003,
10998-30880, 874-298-1190**RIVET- SCREW TYPE HEADLAMP**
HOUSING TO GRILLE
PlasticHole: M5, Washer Head: 15MM
P. R.: 2.0MM - 6.0MM
Honda Accord '84/
Nissan: Isuzu, Various Applications
UNIT PACKAGE 25**91-6971**

Replaces: 91635-SM4-003

GROMMET NUT- HEADLAMP TO GRILLE
SPACER BRACKET
Plastic, Screw: M5
Honda Accord '90/
UNIT PACKAGE 10

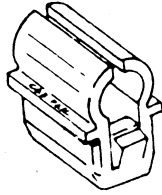
**89-6717**

Replaces: 34355-SD2-003
RETAINER-LAMP ASSEMBLY
 SIDE MARKER LAMP
 Plastic
 Honda Accord '86/
UNIT PACKAGE 15

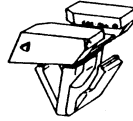
**91-6927**

Replaces: 91580-SH3-003
RETAINER-CORNERING LAMP
 Plastic
 Honda Civic '90/
UNIT PACKAGE 10

**82-5555**

Replaces: 90671-SA5-0030
NUT-FRONT BUMPER LICENSE
 Plate Attaching
 Honda
UNIT PACKAGE 50

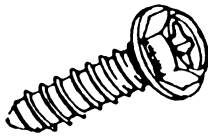
**89-6713**

Replaces: 91500-SM4-999AH
SCREW-LICENSE PLATE
 Indented Hex Phillips Washer Hd.
 Type "AB"
 M6 x 20MM, 10MM A/F, 12MM Flange
 Zinc Dichromate Gold Finish
 Honda '90/
UNIT PACKAGE 50

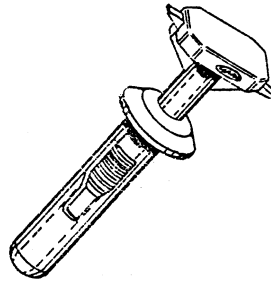
**83-5696**

Replaces: 90674-SO5-0030
CLIP-BODY MOULDING
 Honda
UNIT PACKAGE 25

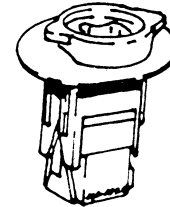
**90-6740**

Replaces: 91623-SM2-003
GROMMET NUT-DOOR WINDOW
 GUIDE TO FRAME
 Screw: M4
 Plastic
 Honda Accord 2 Door '90/
UNIT PACKAGE 10

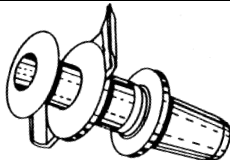
**99-8098**

Replaces: 90663-671-003, 90663-692-003
RETAINER-DOOR TRIM PANEL
 Plastic - 2 piece
 Formerly 84-5778
 Hole: M8.5, Flange: 12.7MM,
 Lower Hd: 16MM,
 Upper Hd.: 12.7MM, O/L: 21.5MM
 Honda various models '76 - '89
UNIT PACKAGE 10

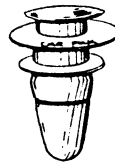
**81-5389**

Replaces: 67771-22020
CLIP- TRIM PANEL
 Honda, Toyota
UNIT PACKAGE 25

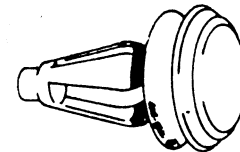
**95-7383**

Replaces: 91560-SM4-003
RETAINER-FRONT DOOR TRIM
 Hole Size: M8
 Plastic
 Honda Accord '90/
UNIT PACKAGE 25

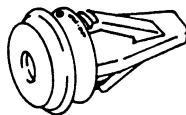
**96-7545**

Replaces: 91566-SP0-003
RETAINER-SEAT PANEL
 Hole: M8.5
 Head Dia.: 12.6MM, O/L: 22.2MM
 Honda Accord '90/
UNIT PACKAGE 15

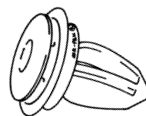
**97-7721**

Replaces: 91560-SP0-003, 91526-S84-A01
RETAINER- DOOR PANEL
 FRONT, REAR & SIDE PLASTIC
 Hole Dia: M9, Sm Head Dia: 13MM
 Slot: 2.5 x 5.75MM, Stem Lgth: 12MM
 Honda & Acura '99/
UNIT PACKAGE 50

**99-8602**

Replaces: 91560-S9A-A01
RETAINER-DOOR PANEL
 Plastic
 Hole: M9, Upper Hd: 13MM, P.R.: 1.5MM,
 O/L: 19MM, Trim Thk.: 2.5MM
 Honda Accord, Civic, CR-V &
 Odyssey 2002/, Acura TL & TSX 2004/
UNIT PACKAGE 25

**99-8618**

Replaces: 91501- SEA-003
RETAINER- FENDER GARNISH MOLDING
 Plastic
 Hole: M6, Flange: 20MM,
 Stem Lgth: 16MM, P.R.: 9MM
 Honda Civic 2006
UNIT PACKAGE 15

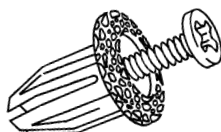
**99-7914**

Replaces: 91550-SH3-003
RIVET-SCREW TYPE
 Front Door Panel, Interior, Lic. Plate
 Garnish
 Plastic
 Hole: M6.6 Sq., Flange: 15MM,
 Stem Length: 13MM, P.R.: 3MM
 Honda Civic & CR-V '92/
UNIT PACKAGE 25

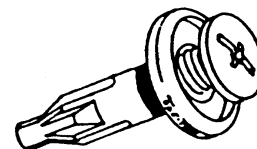
**90-6808**

Replaces: 90505-SM-003
RIVET- SCREW TYPE
 SILL PLATE MOULDING, GARNISH
 Hole: M8, Washer Face: 18MM
 Grip Range: 6-8MM
 Plastic
 Honda Accord '90/
UNIT PACKAGE 10

**99-8147**

Replaces: 90667-671-013ZA,
 62660-48600-1, MC440901
CLIP-INTERIOR TRIM
 Plastic - Textured Head
 Hole: M6, Head: 15.5MM, P.R.: 7MM,
 Stem Length: 15.5MM
 Honda, Nissan & Mitsubishi
UNIT PACKAGE 25

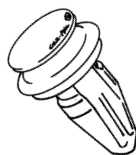
**99-8138**

Replaces: 91560-S84-A11
RETAINER-WINDSHIELD GARNISH PILLAR
 Plastic
 Hole: M8, Stem Lgth: 12MM,
 Middle Head: 16.5MM, Top Head: 13MM
 Acura 3.2CL & Honda Accord, Insight,
 Odyssey, S200 '98/, Element
UNIT PACKAGE 15

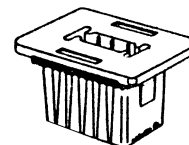
**87-6320**

Replaces: 91608-SE0-003
GROMMET NUT
 WINDSHIELD SIDE MOULDING
 w/SEALER
 Plastic
 Hole: M7 x 12MM
 Panel Range: 1.5MM, Screw M4
 Honda Accord 3 & 4 Door '86/
UNIT PACKAGE 10

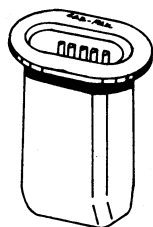
**83-5729**

Replaces: 90683-693-0000
 & 78856-R4301
SCREW-ANCHOR ADJUSTABLE
 Hole: 8MMx15MM, Screw: M4.2
 Datsun, Honda
UNIT PACKAGE 25

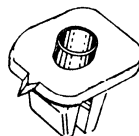
**84-5771**

Replaces: 90666-SA6-003
NUT-ARM REST RETAINER
 M6
 Honda Accord & Civic '82 - Up
UNIT PACKAGE 25

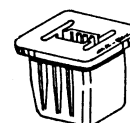
**83-5734**

Replaces: 90668-688-0030
SCREW-ANCHOR, ADJUSTABLE
 Hole: 7MM x 10MM
 Honda
UNIT PACKAGE 25

**84-5773**

Replaces: 90662-693-003, 90189-04066
NUT GROMMET-REAR QUARTER
 PANEL MOULDING & GENERAL USAGE
 Plastic, w/Seal
 Screw: M4
 Honda Accord '82/, Toyota
UNIT PACKAGE 25

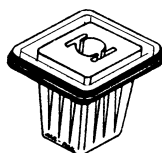
**84-5770**

Replaces: 90675-SA6-003
NUT-GROMMET w/SEAL
 REAR WINDSHIELD
 Honda Accord '82 - Up
UNIT PACKAGE 25

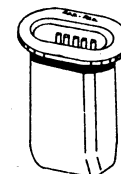
**84-5772**

Replaces: 90681-693-000
SCREW-ANCHOR ADJUSTABLE
 ROOF GARNISH SIDE MOULDING
 Screw: M4
 Honda Accord '82 - Up
UNIT PACKAGE 25

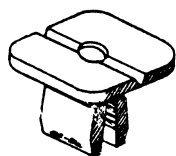
**83-5690**Replaces: 68425-H5000, 9991-00-503
& 90662-671-0030**NUT**General Usage
Datsun, Mazda, Honda
UNIT PACKAGE 25**76-4295**Replaces: 97606B0700,
75522-611-000, 9991-00-412**GROMMET NUT- SIDE MARKER LAMP**
Hole: 1/4", Flange: 0.375, Stem Lgth: 0.265,
P.R.: .110-.125, Screw: #6Also General Use
Datsun, Honda, Mazda
UNIT PACKAGE 100**82-5461**Replaces: D128100151,
0128100161, 96706K1300,
90672-671-811, MB-106212**GROMMET NUT**Honda, Datsun B310, Mitsubishi
UNIT PACKAGE 25**94-7216**

Replaces: 90682-SB0-003

GROMMET NUT-GRILLE

Screw: M5

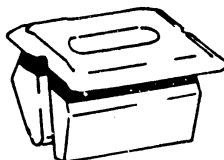
Square Hole: 8MM sq.
PlasticHonda '84/
UNIT PACKAGE 25**96-7532**

Replaces: 91619-SM4-003

GROMMET- CENTER PILLAR

White Plastic

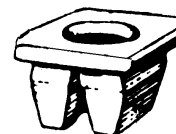
Hole: 12 x 7MM, Head: 10.5 x 15MM
Screw: M3.5Honda Accord '91/
UNIT PACKAGE 25**95-7392**

Replaces: 90676-SA7-003

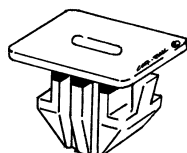
GROMMET NUTHole: 8MM, Sq. Head: 13MM sq.
Screw: M5Plastic
Honda & General Purpose
UNIT PACKAGE 25**98-7861**

Replaces: 90668-SG0-003

GROMMET NUT- SCREW TYPE w/SEALER

GARNISH MOULDING

Plastic

Screw: M4, Hole: M7 X 10MM
Flange: 11 X 14MM, P. R.: .08MM

Honda Accord '90 - '96

UNIT PACKAGE 15**99-7912**

Replaces: 90670-SG0-003, 91626-SH3-003

GROMMET- FRONT DOOR PANEL,

SPEAKERS & DOOR LOCK CONTROL

Plastic-w/Seal

Screw: M4, Hole: M7,
Head: 12MM, PR: 2MMHonda Civic CR-V '93/
UNIT PACKAGE 15**99-8220**

Replaces: 91512-SR3-004

NUT - TUBULAR, EMBLEMS

Plastic w/seal and Closed End

Hole: M6, Flange: 8.5MM, Stud: 3MM
Acura & Integra '94/
Honda Accord, Civic, Prelude & CR-V '94/
*UNIT PACKAGE 10***DRAIN PLUG WASHER****96-7563**

Replaces: 10262143

RETAINER-COWL & INSULATOR

Fits M5 Stud

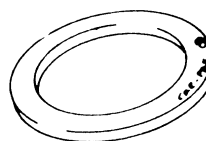
Washer Dia.: 20MM 10MM A/F
Black PlasticG.M. "W" Bodies '96/, Honda & Acura
UNIT PACKAGE 25**90-6856**

Replaces: 90471-PX4-000

WASHER-TRANSMISSION DRAIN PLUG

(aluminum)

18MM ID x 26MM OD x 2MM THK
(Must be replaced w/each fluid change)Honda Accord '90/
*UNIT PACKAGE 50***90-6857**

Replaces: 94109-14000

WASHER-OIL DRAIN PLUG

(aluminum)

14MM ID x 22MM OD x 2MM THK
(Must be replaced w/each oil change)Honda All Models '84/
UNIT PACKAGE 50

HYUNDAI

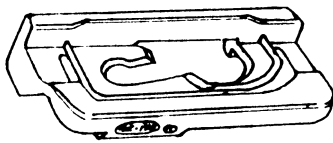
**85-5936**

Replaces: MB 198536
CLIP-WINDSHIELD MOULDING
 Hyundai Sonata '88/
 Dodge Conquest
 Mitsubishi Starion '84/
UNIT PACKAGE 25

**94-7319**

Replaces: BO92-51-833, W705845-S300,
 86590-28000
**RIVET-SCREW TYPE HEADLAMP
 SPLASH SHIELD,COWL VENT**
 Hole: M8, Flange: 18MM, P.R.: 3-7MM
 Plastic
 Ford Probe '89-'92, Escape '01/
 Mazda '99/ & Hyundai/Kia
UNIT PACKAGE 25

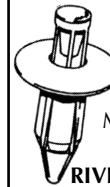
**90-6806**

Replaces: 96057846
 09409-07308-281,
 MB475404, 90467-07076,
 86155-22000
**RIVET-DRIVE TYPE (Removeable)
 COWL, FRONT BUMPER**
 Hole: M6, Washer: 15MM, P.R.: 2-5MM
 Plastic
 Toyota Rav 4, G.M. Geo Tracker '89/
 Chrysler & Mitsubishi '95/
 Suzuki Sidekick '89/, Hyundai Accent,
 Sonata '95/, Kia Optima 2001
UNIT PACKAGE 10

**99-8504**

Replaces: 86593-24000
**RETAINER-BUMPER & GRILLE
 MOUNTING**
 13.1 X 29.7MM
 Hyundai Accent, Santa Fe, Sonata '95/
UNIT PACKAGE 25

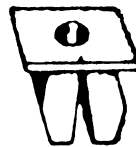
**89-6585**

Replaces: 99910 0501, 14910-05000
**GROMMET NUT-ROCKER PANEL,
 FRONT BUMPER**
 Screw M4.2, Hole: 8MM sq.
 Plastic
 Ford Probe '88, Mazda MX6 '88/,
 Hyundai '86/
UNIT PACKAGE 50

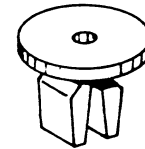
**88-6516**

Replaces: 87453-14500
GROMMET NUT
 M8 Square Hole M6 Screw
 Black Plastic Fender Well
 Hyundai Stellar '85-'87
UNIT PACKAGE 25

**99-8473**

Replaces: 86848-22000
GROMMET-FENDER APRON
 Plastic
 Hole: 8.5MM sq., Flange: 16MM,
 O/L: 12.5MM, Screw: M4.8 (#10)
 Hyundai Accent, Elantra, Sonata,
 Tiburon '95/
UNIT PACKAGE 25

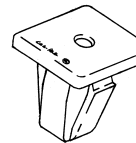
**99-8507**

Replaces: 87758-37000
**GROMMET-FENDER &
 ROCKER MOULDING**
 Plastic w/Seal
 Hole: 8x10MM, Flange: 17MM Sq.,
 P.R.: 2MM, Screw: M4.2(#8)
 Hyundai Accent & Sonata '99/
 Kia Optima & Sorrento 2001/
UNIT PACKAGE 25

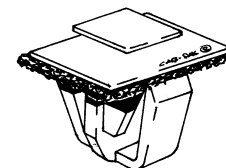
**99-8475**

Replaces: 87756-38000
RETAINER-ROCKER MOULDING
 Plastic, w/Seal
 Hole: 9.5x12MM, Flange 14x18MM,
 Upper Hd: 8x9MM, O/L: 15MM
 Hyundai Sonata '95/ & Kia Optima 2001
UNIT PACKAGE 15

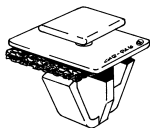
**99-8476**

Replaces: 87758-35000
RETAINER-ROCKER MOULDING
 Plastic, w/Seal
 Hole: 9.5x12MM, Flange 14x19MM,
 Upper Hd: 10x11MM, O/L: 14MM
 Hyundai Accent, Santa Fe
 & Tiburon '95/
UNIT PACKAGE 15

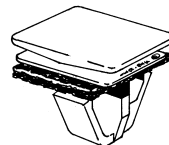
**99-8477**

Replaces: 87758-3D000
RETAINER-ROCKER MOULDING
 Plastic-Yellow, w/Seal
 Hole: M12 Slot,
 Upper Hd: 16x20MM,
 Trim Thk: 2.3MM
 Hyundai Sonata 2002/
UNIT PACKAGE 15

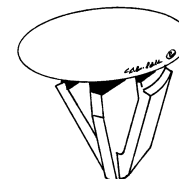
**99-8472**

Replaces: 81126-37010
RETAINER-HOOD INSULATION
 Plastic-Textured
 Hole: M9, Head: 26MM, O/L: 15.5MM
 Hyundai Elantra, Sonata, Tiburon '96/ &
 Kia XG300/350, Optima 2001
UNIT PACKAGE 25

HYUNDAI

IMPORT PARTS



99-8478

Replaces: 92351-37000
RETAINER-HEADLAMP ASSEMBLY
 Plastic
 Hole: 9.7MM, Flange: 14.5MM,
 O/L: 10MM
 Hyundai XG300/350 2001/ &
 Kia Rio, Spectra 2000/
 UNIT PACKAGE 50

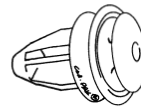

99-8503

Replaces: 82315-38000, 94530565
RETAINER-DOOR & INTERIOR
 TRIM PANEL
 Plastic
 Hole: M9, Upper Hd.: 13MM,
 P.R.: 1.5MM, O/L: 17MM, Trim Thk.: 2MM
 Hyundai Accent, Santa Fe,
 Sonata, Tiburon & XG300/350 '99/
 Kia Optima, Rio & Sorento 2001/
 Chevrolet Aveo 2004/
 UNIT PACKAGE 25

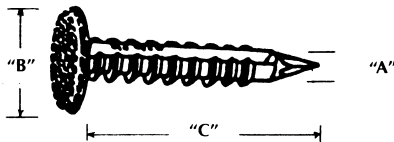

HYUNDAI TRIM CLIPS
 Used On Various Interior Applications

| CAR-PAK # | HYUNDAI # | HOLE DIA 'A' | HEAD DIA 'B' | LENGTH 'C' | COLOR | UNIT PKG |
|-----------|----------------|--------------|--------------|------------|--------------|----------|
| 87-6219 | 14943-05210 DL | M5 | 13.0mm | 21.0mm | Regatta Blue | 100 |
| 87-6220 | 14943-05210 BL | M5 | 13.0mm | 21.0mm | Sand Beige | 100 |
| 87-6221 | 14943-05210 AM | M5 | 13.0mm | 21.0mm | Smoke Gray | 100 |
| 87-6222 | 14943-05300 DL | M5 | 13.0mm | 30.0mm | Regatta Blue | 100 |
| 87-6223 | 14943-05300 BL | M5 | 13.0mm | 30.0mm | Sand Beige | 100 |
| 87-6224 | 14943-05300 AM | M5 | 13.0mm | 30.0mm | Smoke Gray | 100 |

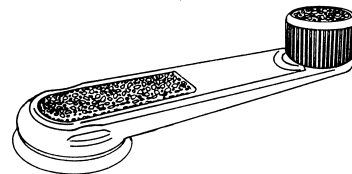

Window Regulator Handle

HYUNDAI-EXCEL '86-'89

86-6137

Replaces:
 82630-21000BL
 Sand Beige
 UNIT PACKAGE 6

86-6138

Replaces:
 82630-21000DL
 Regatta Blue
 UNIT PACKAGE 6

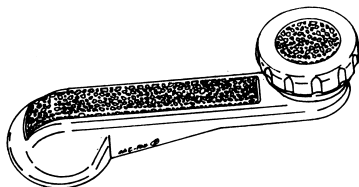

Window Regulator Handle

HYUNDAI-PONY '84-'86

86-6135

Replaces:
 82630-11203BL
 Sand Beige
 UNIT PACKAGE 6

86-6136

Replaces:
 82530-11203DL
 Regatta Blue
 UNIT PACKAGE 6

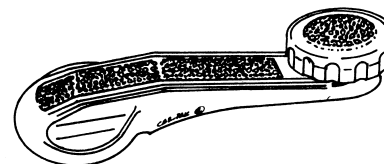

Window Regulator Handle

HYUNDAI-STELLAR '85-'87

86-6140

Replaces:
 82630-31001AM
 Smoke
 UNIT PACKAGE 6

86-6141

Replaces:
 82630-31001BL
 Sand Beige
 UNIT PACKAGE 6

86-6142

Replaces:
 82630-31001A
 Gray
 UNIT PACKAGE 6

INFINITY

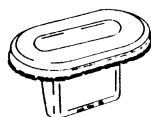

91-6949

Replaces: 80874-85E00, 80874-3Z600
GROMMET-COWL GRILLE
 Plastic w/Sealer
 Use w/92-7012
 Nissan Maxima '90/, Altima '93/ &
 Infinity '96/
 UNIT PACKAGE 15

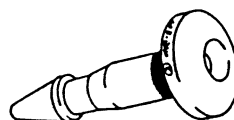

92-7012

Replaces: 66820-88E00
CLIP-COWL SCREEN
 Plastic Use w/91-6949 or 99-8463
 Head Dia.: 10MM, O/L: 18MM
 Nissan Maxima '90/, Altima '93/ &
 Infinity '96/
 UNIT PACKAGE 25

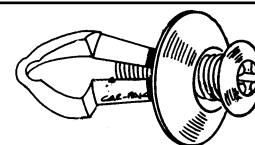

83-5741

Replaces: 66860-01W01
RIVET-COWL PANEL TO
 REINFORCEMENT PLATE
 Hole: M6, Panel Range 2-8MM
 Washer Face: 14MM
 Black High Gloss Finish
 Datsun '80/, Infinity '91/
 UNIT PACKAGE 25

**99-8755**

Replaces: 01553-05323
RIVET-DRIVE TYPE, COWL, BUMPER, FENDER LINER & ENGINE UNDER COVER - Plastic, Textured
 Hole: M8, Flange: 20MM, Stem Lgth: 12MM, P.R.: 2-6MM
 Infinity FX35/45, G35 2003/
 Nissan Cars & Trucks 2004/
UNIT PACKAGE 10

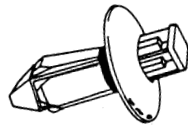
**91-6918**

Replaces: 01553-06721
RIVET-DRIVE TYPE
FRONT & REAR BUMPER COVERS
 Plastic
 Hole: M8, Washer Face: 19MM
 G.R.: 3-6MM
 Nissan Maxima '90/
 Infinity Q45 (Rear) '90/
UNIT PACKAGE 15

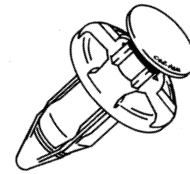
**98-7854**

Replaces 01553-0932, MR3289541
RIVET-DRIVE TYPE (REUSABLE)
Plastic-Front Fender & Bumper
 Hole: M8, Flange: 20MM, P.R.: 4MM
 Nissan '94/, Infinity '93/
 & Chrysler/Mitsubishi '99/
UNIT PACKAGE 15

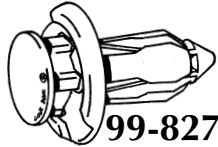
**99-8275**

Replaces: 01553-09611, 01553-10501, 90467-08185
RETAINER - DRIVE TYPE
Grille, Bumpers, Trunk Trim
 Plastic
 Hole: M8, Flange: 18MM
 Stem Length: 10MM, P.R.: 6.3MM
 Nissan Maxima, Sentra '94/
 Infinity G20, I35, Q45 '99/
 Lexus & Toyota '97/, Scion 2004/
UNIT PACKAGE 15

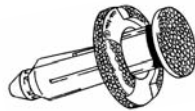
**99-8494**

Replaces: 11296-AG000
RIVET-DRIVE TYPE (Re-usable)
Front Bumper & Radiator Support
 Plastic - Textured
 Hole: M8, Flange: 20MM,
 Stem Lgth: 13MM. P.R.: 2-6MM
 Nissan Altima, Maxima & Quest 2002/
 Infinity FX35/45 2003/
UNIT PACKAGE 25

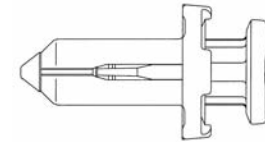
**99-8554**

Replaces: 63848-9E001
RIVET-DRIVE TYPE
Bumper Cover
 Plastic
 Hole: M9, Flange: 18MM,
 O/L: 33.5MM, P.R.: 12MM Max.
 Nissan Altima & Xterra 1998/
UNIT PACKAGE 15

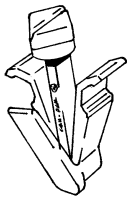
**99-8344**

Replaces: 76882-0M060
RETAINER - FRONT BUMPER & RADIATOR GRILLE
 Plastic
 Nissan '95/ & Infinity 2002/
UNIT PACKAGE 10

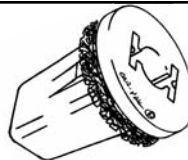
**99-8492**

Replaces: 01281-00331
GROMMET-BUMPER, ROCKER PNL. & LAMP MTG., Plastic w/Seal
 Hole: M10sq., Flange: 20 MM,
 O/L: 17MM, P.R.: 3MM, Screw: M6.3 (#14)
 Nissan 240SX, Altima, Maxima,
 Pathfinder & Quest '96/
 Infinity G35, Q45 & QX4 '97/
UNIT PACKAGE 25

**99-8493**

Replaces: 01281-00831
GROMMET-BUMPER, FENDER & LAMP MTG., Plastic
 Hole: M8.5sq., Flange: 16 MM,
 O/L: 11MM, P.R.: 1.5MM, Screw M4.2 (#8)
 Nissan 240SX, Altima, Frontier,
 Maxima, Pathfinder, Quest & Xterra '89/
 Infinity G20, I30/35 & QX4 '91/
UNIT PACKAGE 25

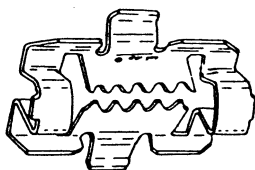
**90-6801**

Replaces: 62228-61A00
RETAINER-FRONT BUMPER CUSHION
 Metal
 Nissan Sentra '87/ & Infinity Q45 '91/
UNIT PACKAGE 15

**92-7097**

Replaces: 63848-D4000
CLIP-INNER FENDER PANEL
 Plastic
 Hole: M6
 Nissan & Infinity Models '89/
UNIT PACKAGE 15

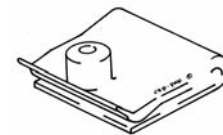
**99-8685**

Replaces: 76882-0M000
U-NUT-FENDER
 Plastic
 Screw: M4.8(#10), Width: 20MM,
 Length: 20.5MM, Throat: 8MM
 Nissan '95/ & Infinity '96/
UNIT PACKAGE 15

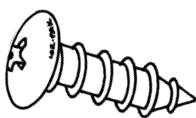
**97-7634**

Replaces: 08540-61608
SCREW- PHILLIPS TRUSS HEAD
 M6 x 15MM
 Head Dia: 13.5MM
 Black Finish
 Use with 92-7097
 Nissan '88/
UNIT PACKAGE 50

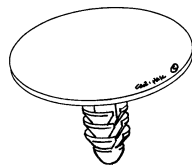
**99-8343**

Replaces: 65846-40F00
RETAINER - HOOD INSULATOR
 Plastic
 Hole: M5, Flange: 28MM,
 Stem Lgth: 10MM, O/L: 12MM
 Nissan '93/ & Infinity '89/
UNIT PACKAGE 15

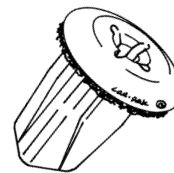
**99-8339**

Replaces: 01281-00711
GROMMET - ROCKER MOULDING
 Plastic - w/Seal
 Hole: 10MM sq., Flange: 20MM,
 O/L: 16.5MM, P.R.: 2MM, Screw: M4.2 (#8)
 Nissan & Infinity '95/
UNIT PACKAGE 10

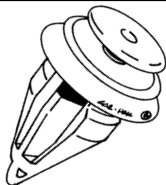
**99-8341**

Replaces: 01553-07111
RETAINER - DOOR PANEL
 Plastic
 Hole: M8, Upper Head 13MM,
 Trim Thk: 3MM, O/L: 20MM, P.R.: 1.5MM
 Nissan Altima 2002/ &
 Infinity Q45, G35 '97/
UNIT PACKAGE 15

**99-8342**

Replaces: 01553-09791
RETAINER - DOOR PANEL
 Plastic
 Hole: M8, Upper Hd.: 13MM,
 Trim Thk: 2.5MM, O/L: 20MM, P.R.: 1.5MM
 Nissan 2000/ & Infinity '99/
UNIT PACKAGE 15

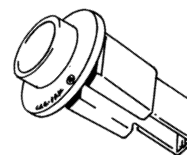
**99-8462**

Replaces: 01281-01081
GROMMET-FRONT BUMPER
 Plastic
 Hole: M10 sq., Flange: 16MM,
 Stand off 3.5x10MM,
 O/L: 22MM, P.R.: 2.5MM, Screw: M4.8 (#10)
 Nissan & Infinity '97/
UNIT PACKAGE 15

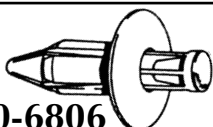
KIA**90-6806**

Replaces: 96057846, 09409-07308,
 MB475404, 90467-07076, 86155-22000
RIVET-DRIVE TYPE (Removeable)
 COWL, FRONT BUMPER, Plastic
 Hole: M6, Washer: 15MM, P.R.: 2-5MM
 Toyota Rav 4, G.M. Geo Tracker '89/
 Chrysler & Mitsubishi '95/
 Suzuki Sidekick '89/, Hyundai Accent,
 Sonata '95/, Kia Optima 2001
UNIT PACKAGE 10

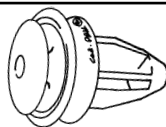
**99-8313**

Replaces: MG350-68AB1, G350-68-AB1
RETAINER - DOOR & INTERIOR
 TRIM PANEL
 Plastic
 Hole: M9, Upper Hd.: 13MM, P.R.: 1MM,
 O/L: 16MM, Trim Thk.: 2MM
 Ford Probe '92/, Mazda '89/ & Kia Rio,
 Sephia & Spectra '98/
UNIT PACKAGE 10

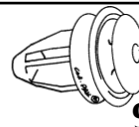
**99-8503**

Replaces: 82315-38000, 94530565
RETAINER-DOOR & INTERIOR
 TRIM PANEL, Plastic
 Hole: M9, Upper Hd.: 13MM,
 P.R.: 1.5MM, O/L: 17MM, Trim Thk.: 2MM
 Hyundai Accent, Santa Fe,
 Sonata, Tiburon & XG300/350 '99/
 Kia Optima, Rio & Sorento 2001/
 Chevrolet Aveo 2004/
UNIT PACKAGE 25

**88-6499**

Replaces: 90467-12020, H200-50-715
 BF67-50715, KKY01-50-715
CLIP-GRILLE & HEADLAMP DOOR
 Gray Plastic
 Toyota Corolla '83/, Chevrolet Nova '86/
 Mazda 323 '86/. Ford Festiva & Tracer '88/
 Kia Sportage '95/
UNIT PACKAGE 25

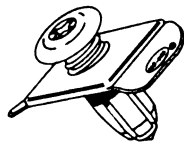
**97-7670**

Replaces: BF67-50-033, MBF67-50-033
RIVET-SCREW TYPE
 BUMPER COVER RETAINER
 Plastic
 Hole: M10, G.R.: 2-7MM
 Mazda 323 '86/
 Kia
UNIT PACKAGE 10

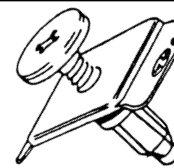
**90-6766**

Replaces: E7GZ-17A904-G,
 BF82-50-233, & MBF82-50-233
RIVET-SCREW TYPE FRONT & REAR
 BUMPER COVER
 Hole: M10, P.R.: 7-12MM
 Ford Escort, Mercury Tracer '87/,
 Mazda 323 '87/,
 Kia Spectrum, Sportage '93/
UNIT PACKAGE 10

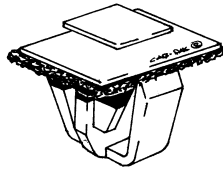

99-8475

Replaces: 87756-38000
RETAINER-ROCKER MOULDING
 Plastic, w/Seal
 Hole: 9.5x12MM, Flange 14x18MM,
 Upper Hd: 8x9MM, O/L: 15MM
 Hyundai Sonata '95/ & Kia Optima 2001
UNIT PACKAGE 15

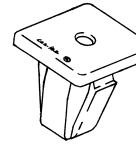

99-8507

Replaces: 87758-37000
GROMMET-FENDER & ROCKER MOULDING
 Plastic w/Seal
 Hole: 8x10MM, Flange: 17MM Sq.,
 P.R.: 2MM, Screw: M4.2(#8)
 Hyundai Accent & Sonata '99/
 Kia Optima & Sorrento 2001/
UNIT PACKAGE 25



99-8472

Replaces: 81126-37010
RETAINER-HOOD INSULATION
 Plastic-Textured
 Hole: M9, Head: 26MM, O/L: 15.5MM
 Hyundai Elantra, Sonata, Tiburon '96/ &
 Kia XG300/350, Optima 2001
UNIT PACKAGE 25



99-8478

Replaces: 92351-37000
RETAINER-HEADLAMP ASSEMBLY
 Plastic
 Hole: 9.7MM, Flange: 14.5MM,
 O/L: 10MM
 Hyundai XG300/350 2001/ &
 Kia Rio, Spectra 2000/
UNIT PACKAGE 50

LEXUS

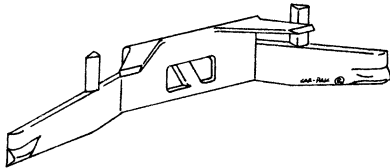

97-7743

Replaces : 75545-24030
CLIP-WINDSHIELD MOULDING TOP
 Plastic-White
 Lexus SC300, 400 '92/
UNIT PACKAGE 10

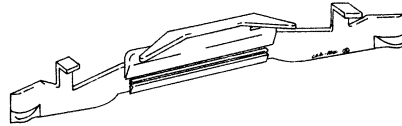

97-7744

Replaces: 75545-32040
CLIP-WINDSHIELD MOULDING SIDE
 Plastic-White
 Lexus ES300 '92/'96
UNIT PACKAGE 10

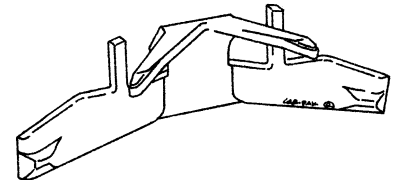

97-7745

Replaces: 75961-32050
CLIP-WINDSHIELD MOULDING
 Corner
 Plastic-Black
 Lexus ES300 '92/'96
UNIT PACKAGE 10



99-8356

Replaces: 88970345, 90467-10167
RETAINER - WINDSHIELD GARNISH MOULDING
 Plastic
 Hole: M8.5, Upper Hd: 13MM,
 O/L: 17.5MM,
 Trim Thk: 2.5MM
 Pontiac Vibe 2003 & Toyota/Lexus 2000/
UNIT PACKAGE 25

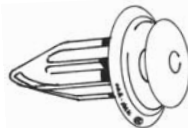

99-8574

Replaces: 90467-10188, 91560-S6A-003
RETAINER-COWL, W/S GARNISH, INTERIOR TRIM, Plastic w/Seal
 Hole: M8.5, Upper head: 13MM,
 Trim Thk: 2.5MM, O/L: 20MM,
 P.R.: 0.7-1.4MM
 Toyota Cars & Trucks '98-2004
 Acura 2005/ & Honda 2004/
UNIT PACKAGE 25

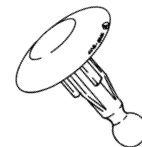

99-8099

Replaces: 90467-06093
RETAINER-COWL VENT
 Plastic - Use with 98-7791
 Head: 20MM, Stem Length: 18MM
 Lexus LS400, GS300, SC300/400 '95/ &
 Toyota
UNIT PACKAGE 10

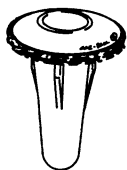
**98-7791**

Replaces: 90467-10152
GROMMET-COWL VENT
 Plastic Use with 98-7792 or 99-8099
 Hole: M9, Flange: 18MM
 Stem Length: 16MM
 Lexus '95/ & Toyota
UNIT PACKAGE 10

**98-7792**

Replaces: 90467-07126
PIN RETAINER-COWL VENT
 Plastic Use With 98-7791
 Head: 16MM, Stem Length: 17MM
 Lexus '95/
UNIT PACKAGE 10

**91-6917**

Replaces: 90467-09093
RIVET-SCREW TYPE
 Plastic
 Hole Size M9
 Flange 15mm: G.R. 3-7mm
 Front & Rear Bumper Cover
 Lexus LS-400 '90/
UNIT PACKAGE 10

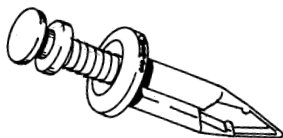
**96-7603**

Replaces: 90467-09096
RIVET- SCREW TYPE
 Front & Rear Bumper
 Plastic
 Hole Dia: M9, Stem Lgth: 26.5MM
 Washer Dia: 15MM
 Lexus, LS400, SC300, SC400 '95-2000
 Toyota Supra '93-'98
UNIT PACKAGE 10

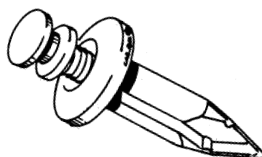
**96-7604**

Replaces: 90467-09128
RIVET- SCREW TYPE
 Bumper Cover
 Plastic
 Hole Dia: M9, Stem Lgth: 26.5MM
 Washer Dia: 20MM
 Lexus '95-2000
UNIT PACKAGE 10

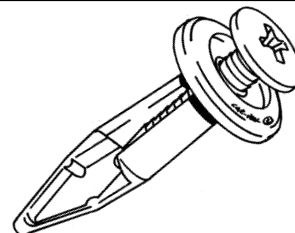
**98-7855**

Replaces: 90467-09127
RIVET-SCREW TYPE
 Plastic-Front Bumper Cover
 Hole: M9, Flange: 20MM, P.R.: 6MM
 Lexus ES 300 '97-2000, Toyota '97
UNIT PACKAGE 10

**98-7856**

Replaces 90467-07117
RIVET-DRIVE TYPE (PUSH TO RELEASE)
 Cowl Grille
 Plastic
 Hole: M7, Flange: 17MM, P.R.: 3MM
 Lexus '97/, Toyota Camry '98 & Prius '01/
UNIT PACKAGE 10

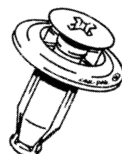
**99-7911**

Replaces: 90467-07146
RIVET- DRIVE TYPE, PHILLIPS HEAD
 Cowl Grille & Trunk Trim
 Plastic
 Hole: M7, Flange: 16MM, P.R.: 3MM
 Toyota Solara '99, Lexus & ES 300 '97/
UNIT PACKAGE 10

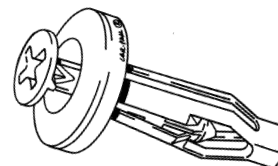
**98-7790**

Replaces: 90467-09143
RIVET-DRIVE TYPE (Twist to Release)
 Rear Bumper Cover, Plastic
 Hole: M9, Flange: 19MM , P.R.: 5.5MM
 Lexus '90/
 Toyota Supra '93-'98
UNIT PACKAGE 10

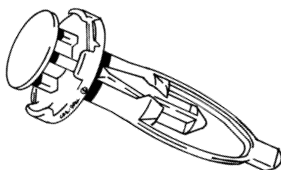
**96-7606**

Replaces: 52161-16010, 94858560
RETAINER- FRONT-BUMPER
 Plastic-Black
 Hole Dia: M9, Flange Dia: 18MM
 Stem Lgth: 28MM
 Toyota Tercel '95/, Lexus '97/ &
 Pontiac Vibe 2003/
UNIT PACKAGE 5

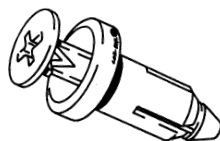
**98-7793**

Replaces: 90467-09145
RIVET-DRIVE TYPE (Twist To Release)
 Front Bumper Cover
 Plastic
 Hole: M9, Flange: 15MM, P.R.: 5MM
 Lexus '92/
UNIT PACKAGE 10

**98-7770**

Replaces: 90467-09139
 01553-03803
RIVET-DRIVE TYPE, FRONT BUMPER
 Plastic
 Hole: M9, Washer Dia: 18MM
 Stem Length: 12MM
 Toyota Corolla '95/, Nissan
UNIT PACKAGE 10

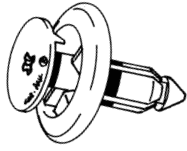

99-8357

Replaces: 88970494, 88973676,
90467-07168

RIVET - PIN DRIVE (TWIST TO RELEASE)
Rocker & Garnish Moulding
Plastic
Hole: M7, Flange: 20MM,
Stem Lgth: 8.5MM, P.R.: 5MM
Pontiac Vibe 2003 & Toyota/Lexus 2000/
UNIT PACKAGE 15

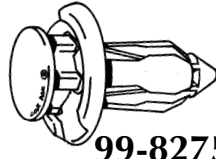

99-8275

Replaces: 01553-09611,
01553-10501, 90467-08185

RETAINER - DRIVE TYPE
Grille, Bumpers, Trunk Trim, Plastic
Hole: M8, Flange: 18MM
Stem Length: 10MM, P.R.: 6.3MM
Nissan Maxima, Sentra '94/
Infinity G20, I35, Q45 '99/
Lexus & Toyota '97/, Scion 2004/
UNIT PACKAGE 15



99-8587

Replaces: 90467-07201
RIVET-DRIVE TYPE, Engine Under Cover
Plastic
Hole: M7, Flange: 20MM,
Stem Lgth: 10MM, P.R.: 2.2-6.5MM
Toyota Avalon, Camry, Solara 2002/
& Lexus ES300/330 2002/
UNIT PACKAGE 10

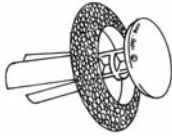

99-8764

Replaces: 90467-07211
DRIVE RIVET-BUMPER,
RADIATOR COVER, GRILLE
Plastic-Textured
Hole: M7, Flange: 19MM,
Stem Lgth: 8MM & 10MM, P.R.: 6MM
Toyota Avalon, Camry, Highlander 2005/
Scion xB 2008, Lexus IS & LS 2007/
UNIT PACKAGE 10

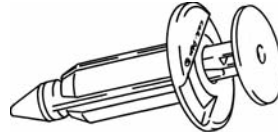

99-8794

Replaces: 75867-30120
RETAINER-ROCKER MOULDING
Plastic
Hole: M8.5, Flange: 18MM,
Stem Lgth: 12MM, Head: 15MM,
P.R.: 5.5-7.0MM
Toyota Camry & Avalon 2005/
Lexus ES, GS, IS & LS 2006/
UNIT PACKAGE 15

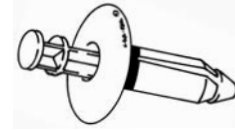

99-8680

Replaces: 90467-08180
RIVET- DRIVE TYPE, BUMPER
& ROCKER PANEL
Plastic, Textured
Hole: M8, Flange: 17MM,
Stem Lgth: 12MM, P.R.: 7MM
Toyota Camry 2007
Lexus RX335/350/400h 2004/
UNIT PACKAGE 15



82-5559

Replaces: 90467-08004, 90467-08011,
90080-46010, 90467-A0009
CLIP-PANEL
Hood Seal
Toyota, Lexus
UNIT PACKAGE 50



99-8397

Replaces: 67868-02020, 67867-12150
RETAINER- FRONT & REAR
DOOR WEATHERSTRIP
Plastic
Hole: M6, Head: 5x15MM, O/L: 15MM
Toyota Cars & Trucks '90/ & Lexus '99/
Scion xB 2004/
UNIT PACKAGE 25

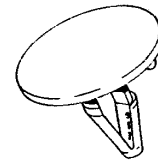

97-7708

Replaces: 90467-08124
RETAINER-HOOD INSULATION
Plastic
Hole: M7, Head Dia: 25MM,
Stem Lgth: 12MM
Toyota Supra & Lexus '89/
UNIT PACKAGE 15

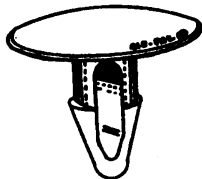

98-7824

Replaces: 90467-09006
RETAINER- HOOD INSULATION
Plastic w/Textured Head
Hole: M7, Head: 30MM
P.R.: 4MM
Toyota Camry & Lexus '88/
UNIT PACKAGE 15

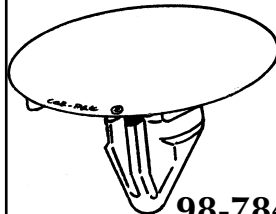

98-7848

Replaces: 90467-09050, 90467-A0003,
88970747, 94858509
RETAINER-HOOD INSULATOR
Plastic
Hole: M8, Head: 25MM, G.R.: 4MM
Toyota Camry, Lexus, Scion,
Pontiac Vibe 2003/
UNIT PACKAGE 15



99-8151

Replaces: 90467-08186
RETAINER - TRIM PANEL
Interior Trunk & Quarter Panels
Plastic
Hole: M7, Head: 16MM,
Stem Length: 16MM, O/L: 19.5MM
Toyota Camry, Lexus ES300,
GS300/400, RX300 '97/
UNIT PACKAGE 15

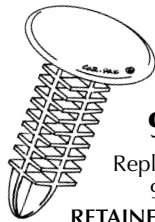
**99-8398**

Replaces: 88970656,
90467-05020

**RETAINER-ROCKER PANEL &
INTERIOR TRIM**
Plastic

Hole: M5, Head:16MM,
Stem Lgth: 16MM, P.R.: 1.5-10MM
Pontiac Vibe 2003,
Toyota Celica '94-99 & Lexus RX300 '99/
UNIT PACKAGE 50

**99-8175**

Replaces: 90467-06070
RETAINER - HEADLINER
Plastic - Textured Head, Paint to match
Hole: M5, Hd: 25MM
Stem Length: 17MM
Toyota RAV 4, Land Cruiser '91/
Lexus LX450 '96-'97
UNIT PACKAGE 25

**99-8575**

Replaces: 90467-A0008
RETAINER-BUMPER COVERS
Plastic
Hole: M6.35, Head: 19MM,
Stem Lgth:16MM, P.R.: 2.7-7.3MM
Toyota, Lexus & Scion '95/
UNIT PACKAGE 50

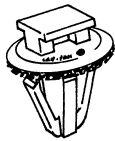
**99-8171**

Replaces: 62955-12010, 94848834
**RETAINER-RADIATOR GRILLE, TRUNK
PANEL, BACK GLASS LOUVER**
Plastic - with sealer
Hole: M8, Flange: 15MM, Head: 8MM Sq.
Toyota Corolla, Rav4 '88/ , Matrix 2003/
Lexus ES300 '92-'96 & Pontiac Vibe 2003/
UNIT PACKAGE 10

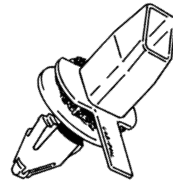
**98-7827**

Replaces: 75039-33060
**RETAINER- LOWER QUARTER PANEL
MOULDING**
Plastic
Lexus ES300
UNIT PACKAGE 5

**98-7826**

Replaces: 75039-33010
**RETAINER- LOWER DOOR PANEL
MOULDING**
Plastic
Lexus ES300 '92-'96
UNIT PACKAGE 5

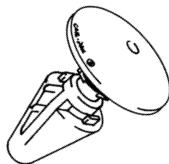
**99-8283**

Replaces: 75867-30110
RETAINER - ROCKER MOULDING
Plastic
Hole: M9, Hd: 18MM, O/L: 23.5MM,
Toyota Avalon, Corolla '97/ &
Lexus ES300/SC400 '97-2001
UNIT PACKAGE 15

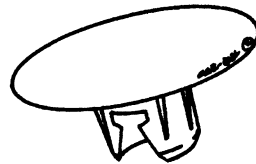
**98-7768**

Replaces: 90467-05085
CLIP-LUGGAGE COMPARTMENT TRIM
Plastic
Fits: M5 Stud, Head Dia: 21MM
Toyota Camry '92/'96, Lexus ES300 '95/
UNIT PACKAGE 10

**99-8274**

Replaces: 90467-06175
RETAINER - TRUNK TRIM
Plastic
Hole: M6, Hd: 16MM, P.R.: 1.5-8.0MM
Stem Length: 16MM, O/L: 19.5MM
Toyota Camry, Solara & Lexus ES300 '97/
UNIT PACKAGE 15

**99-8517**

Replaces: 53879-60010
RIVET- DRIVE TYPE, FENDER LINER
Plastic, Textured Head
Hole: M7, Flange: 18MM,
Stem Lgth: 6.5MM, P.R.: 3.5MM
Toyota Land Cruiser '98/
Rav4 2001/ & Lexus LX470 '98/
UNIT PACKAGE 10

**99-8556**

Replaces: 75396-35020, 75495-35010
**RETAINER-FENDER FLARE &
SIDE MOULDING**
Plastic-Blue
Hole: M9sq., Flange: 17MM, O/L: 17MM
Toyota 4Runner, Tacoma 2003/ &
Lexus GX470 2003-2004
UNIT PACKAGE 15

**99-8555**

Replaces: 75395-35070, 75397-35010
**RETAINER-FENDER FLARE & SIDE
MOULDING**
Plastic-Orange
Hole: M9sq., Flange: 17MM, O/L: 22.5MM
Toyota 4Runner, Tacoma 2003/ &
Lexus GX470 2003-2004
UNIT PACKAGE 15

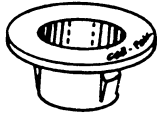

87-6270

Replaces: 90386-06008
CLIP-BODY SIDE MOULDING
 Plastic
 1/4 I.D., 5/16 Hole Clip
 Toyota Celica & Supra '82-'86, Lexus
UNIT PACKAGE 25

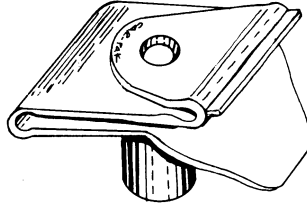

83-5698

Replaces: 53879-14010A
CLIP-INNER FENDER
 M5 Hole
 Toyota, Lexus ES300 '90/
UNIT PACKAGE 25

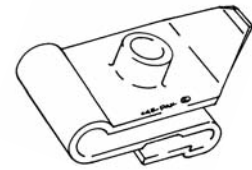

99-8577

Replaces: 90467-05114
U-NUT-BUMPER & FENDER APRON
 Plastic
 Screw: M5.48 (#12)
 Toyota & Lexus 2000/
UNIT PACKAGE 10

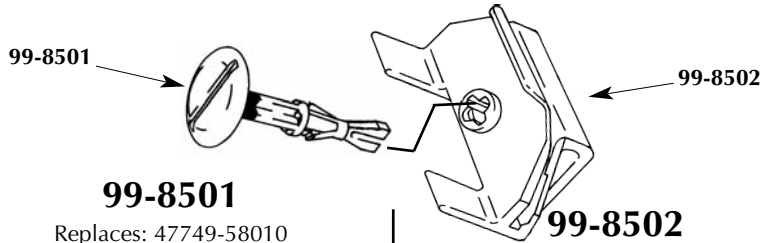

99-8501

Replaces: 47749-58010
PIN-FRONT FENDER
 Plastic, Use w/99-8502
 Head: 15.5MM, Stem Lgth: 25MM
 Toyota Solara, Highlander,
 Sienna & 4Runner 2000/
 Lexus GX470 2003/ & Pontiac Vibe 2009
UNIT PACKAGE 10

99-8502

Replaces: 53879-58010, 19183888
CLIP-FRONT FENDER, FRONT BUMPER
 Plastic, Use w/99-8501
 Toyota Solara, Highlander,
 Sienna & 4Runner 2000/
 Lexus GX470 2003/ & Pontiac Vibe 2009
UNIT PACKAGE 5



99-8677

Replaces: 52535-50060, 52535-0E010
GROMMET-FRONT BUMPER
 Plastic
 Hole: 9x12MM, Screw: M5.48 or M6.0
 Toyota Camry, Highlander
 & Tacoma 2001/
 Lexus RX330/350/400h,
 LS430 & IS250/350 2001/
UNIT PACKAGE 5



98-7894

Replaces: 90189-05012
 8941-340-270
NUT-WIDE RANGE
 M4.2 Screw
 Formerly 85-5979
 Plastic, Various Applications
 Toyota, Isuzu, Lexus
UNIT PACKAGE 25

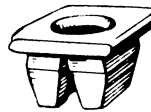

99-8021

Replaces: 90189-06018
**GROMMET-ROCKER PANEL,
 WHEEL OPENING**
 Plastic
 Hole: M9 sq., Flange: 14MM sq.,
 PR: 2.5MM, Screw: M4.2
 Lexus 2003/, Toyota '96/, Scion 2004/
UNIT PACKAGE 15



98-7909

Replaces: N811169-S, W705550-S300,
 90189-06111
**RETAINER-PARK & TURN SIGNAL
 HOUSING, HEADLAMP MOUNTING**
 Plastic, w/Aero Style Lamps
 Hole: M10.5, Head: 13MM
 Ford F250-F550 '99/, Toyota & Lexus '89/
UNIT PACKAGE 50

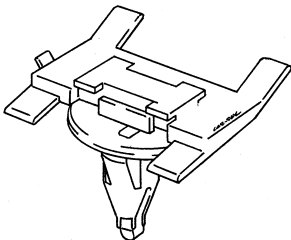

98-7828

Replaces: 75049-33020, 75049-33010
RETAINER-SIDE DOOR CLADDING
 Plastic
 Lexus '90-'96
UNIT PACKAGE 10



97-7715

Replaces: 67771-30090
CLIP-DOOR TRIM PANEL
 Plastic
 Hole: M9, Stem Lgth: 17MM
 Lexus LX 450 '96-'97
 Toyota Land Cruiser '91-'97
UNIT PACKAGE 15



97-7673

Replaces: 95008221, 67771-12050,
 67771-16080, 67771-02030,
 67771-12040
RETAINER- DOOR TRIM, HEADLINER
 Plastic
 Hole Dia: M9
 Lexus '96/, Geo, Prism '93/
 Toyota Car & Truck '88/, Scion 2004/
UNIT PACKAGE 50

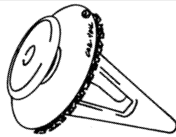
**99-8282**

Replaces: 67771-12070
**RETAINER - DOOR PANEL &
 ROCKER MOULDING**
 Plastic w/Seal

Hole: M9, Upper Hd: 13MM,
 P.R.: 1.5MM, O/L: 19.7MM,
 Trim Thk.: 2.5MM
 Toyota Avalon, Corolla '93/ &
 Lexus SC300/400 '92-2000
UNIT PACKAGE 15



2-PART

99-8359

Replaces: 67771-12080
**RETAINER - DOOR PANEL & ROCKER
 MOULDING**

Plastic - 2 Piece, Yellow Pin,
 White Grommet
 Hole: M8, Upper Hd: 13MM, P.R.: 1MM,
 O/L: 20MM, Trim Thk: 3MM
 Toyota & Lexus '98/
UNIT PACKAGE 15

**99-8375**

Replaces: 90467-10162
**RETAINER - ROCKER MOULDING
 & SCUFF PLATE**
 Plastic

Hole: M8.5, Hd: 13MM, O/L: 17MM,
 Trim Thk: 2MM, P.R.: 1.5MM
 Toyota Cars & Trucks 2000/
 Lexus ES300, RX300 & SC430 '99/
UNIT PACKAGE 25

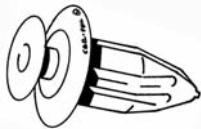
**99-8678**

Replaces: 75867-AA010
**RETAINER-ROCKER PANEL
 & SCUFF PLATE, Plastic**

Hole: M8, Head: 13MM,
 Trim Thk: 2.5MM, O/L: 18MM
 Toyota Avalon, Camry, Solara 2004/
 Scion xA 2004/
 Lexus ES300/330 2002/
UNIT PACKAGE 15

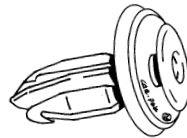
**99-8360**

Replaces: 94178705, 94858299,
 90467-10161

RETAINER - ROCKER MOULDING
 Plastic

Hole: M8.5, Upper Hd: 13MM,
 O/L: 20MM, Trim Thk: 2.6MM, P.R.: 0.7-1.6
 Pontiac Vibe 2003/
 Lexus & Toyota '98/, Scion 2004/
UNIT PACKAGE 50

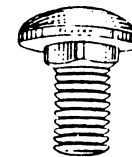
**87-6207**

Replaces: 01135-00511

BUMPER BOLT

Black Chrome Finish
 M6-1.0 x 12.0MM
 Head: 14.0MM
 Imports, Nissan truck '82/
UNIT PACKAGE 25

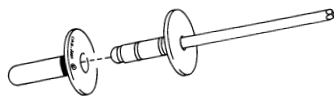
**99-8208**

Replaces: 90269-04050
**BLIND RIVET - WINDSHIELD, SIDE &
 DECK MOULDING**

Hole: M4, Rivet: M3.2, Flange: 8MM,
 G.R.: 4-7.9MM
 Aluminum Rivet w/Steel Mandrel and
 Plastic Seal
 Lexus GS300, 400, 430, & SC430 '98/
UNIT PACKAGE 15

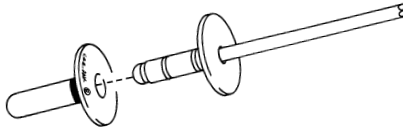
**99-8209**

Replaces: 90269-06013
BLIND RIVET - GAS FILLER DOOR
 Hole: M6, Rivet: M4.8, Flange: 14MM,
 G.R.: 1.6-6.35MM

Aluminum Rivet w/Steel Mandrel
 and Plastic Seal
 Toyota Camry '97/ & Lexus IS300 2001
UNIT PACKAGE 15

**99-8763**

Replaces: 75547-51021

**BLIND RIVET-WINDSHIELD & DRIP
 MOULDINGS w/Plastic Seal**
Rivet-M3.2(1/8"), Flange: 6.4MM(1/4"),
 Rivet Lgth: 9.5MM (3/8")

Seal-Hole: M4(5/32"), Length: 12MM,
 Shoulder: 1.5x6.8MM, Flange: 10.4MM
 Aluminum Rivet/Steel Mandrel
 Toyota Land Cruiser 2007/
 Lexus IS250/350 2006/
UNIT PACKAGE 15

**99-8610**

Replaces: 90269-04051, 90269-A0006
**BLIND RIVET-WINDOW DOOR
 MOLDING**

Hole: M4 (5/32"), Rivet: M3.2 (1/8"),
 Flange: 6MM (15/64"),
 G.R.: 1.2-3.4MM (0.047-0.134),
 Rivet Lgth: 7.1MM (9/32")
 Aluminum Rivet w/ Steel Mandrel
 & Plastic Seal
 Lexus ES, IS Models '98/, Toyota Camry 2007
UNIT PACKAGE 15

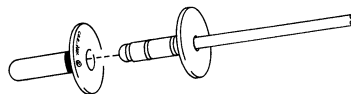
**99-8611**

Replaces: 90269-04006
BLIND RIVET-DOOR BODY MOLDING
 Hole: M4 (5/32"), Rivet: M3.2 (1/8"),
 Flange: 8.0MM (5/16"),
 G.R.: 1.2-4.0MM (0.047-0.157),
 Rivet Lgth: 9.0MM (23/64")

Aluminum Rivet w/ Steel Mandrel
 & Plastic Seal
 Lexus GS Models '98/
UNIT PACKAGE 15

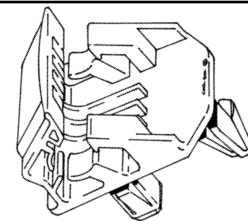
**99-8529**

Replaces: 53271-44010
**RETAINER-HEADLAMP
 HOUSING MOUNTING**
 Plastic

Hole: 1-M9 & 1-M10 sq.
 Toyota Camry & RAV4, Lexus IS300 2001/
UNIT PACKAGE 5

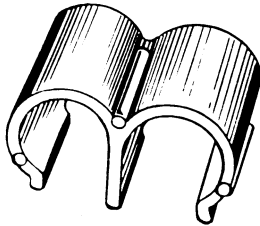

82-5583

Replaces: 90464-00082
90044-64012
CLIP-PIPE CLAMP
Dia.. M6
Toyota & Lexus
UNIT PACKAGE 25

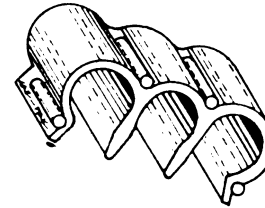

82-5586

Replaces: 90464-00074
18412-74000, 18412-00074
CLIP-PIPE CLAMP
Dia.. M6
Toyota, Lexus & Others
UNIT PACKAGE 25

MAZDA

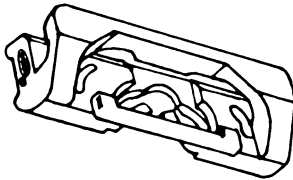

84-5851

Replaces: H001-50-609
CLIP-WINDSHIELD REVEAL MOULDING
Mazda 626 '83/
UNIT PACKAGE 25

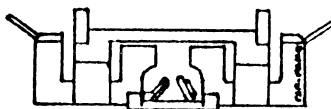

85-6009

Replaces: HA01-50-609
CLIP-WINDSHIELD REVEAL MOULDING
Plastic
Mazda Truck '86/
Tracer '87/
UNIT PACKAGE 25

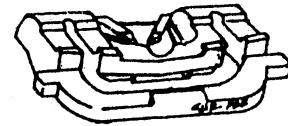

89-6571

CLIP-MOULDING BACK GLASS
Gray Plastic
Ford Probe '88/, Mazda MX6 '88/
Tracer '87/
UNIT PACKAGE 25

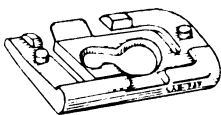

79-4988

Replaces: 72825-47400
CLIP-WINDSHIELD REVEAL MOULDING
Datsun & Mazda
UNIT PACKAGE 50



90-6812

Replaces: B092-50-919
& E7GZ-6142308-B
CLIP-REAR WINDOW MOULDING
Gray Plastic
Mazda 323 '88/
Mercury Tracer '88/
UNIT PACKAGE 15

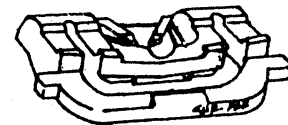

99-8121

Replaces: B092-50-609
CLIP-WINDSHIELD, HATCH, SIDE & REAR MOULDINGS
Plastic
Mazda 323, 626, MX6 '88-'92;
MPV '85-'95; 929 '92-'95
UNIT PACKAGE 15

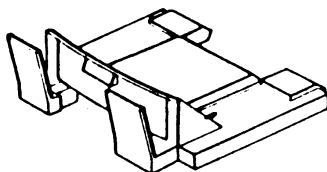

87-6284

CLIP-BACKGLASS
Plastic
Lower Moulding
Mazda 626 '79-'82
UNIT PACKAGE 10



81-5391

Replaces: 1243-SO-609
CLIP-WINDSHIELD REVEAL MOULDING
Mazda RX-7 '84-'85
UNIT PACKAGE 25

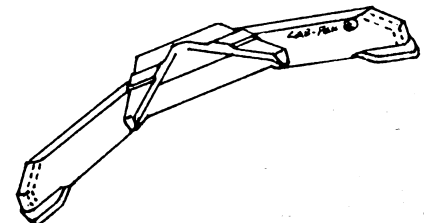

87-6328

Replaces: B092-50-608
CLIP-WINDSHIELD MOULDING
Plastic
Mazda 626 2 Door '86/
Tracer '87/
UNIT PACKAGE 15

**87-6329**

Replaces: G030-50-6A9
CLIP-WINDSHIELD MOULDING UPPER
 Plastic
 Mazda 626 2 Door '86/
UNIT PACKAGE 15

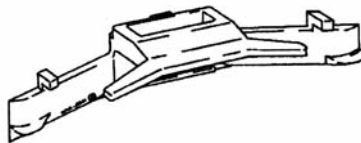
**97-7740**

Replaces: HG30-50-6B9A
CLIP-WINDSHIELD MOULDING
 Front & Rear
 Plastic-Brown
 Mazda 929 '92/'95
UNIT PACKAGE 10

97-7741

Replaces: HG30-50-609
CLIP-WINDSHIELD MOULDING SIDE
 Plastic-White
 Mazda 929 '92/'95
UNIT PACKAGE 10

**91-6892**

Replaces: LA01-50-6A9A
CLIP-WINDSHIELD MOULDING
 Brown Plastic
 Mazda MPV Van '89/
UNIT PACKAGE 10

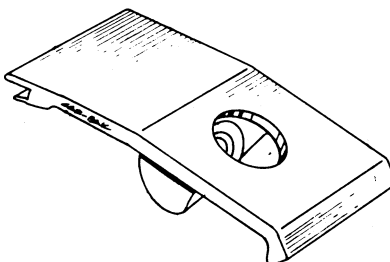
**83-5689**

Replaces: 8871-50-608
CLIP-WINDSHIELD PILLAR POST
 Mazda RX-7 '79
UNIT PACKAGE 25

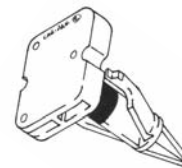
**99-8616**

Replaces: GM9E-63-938A
RETAINER-UPPER WINDSHIELD MOLDING
 Plastic
 Hole: M8, Flange: 17x20MM,
 O/L: 25MM
 Mazda 6 2003/
UNIT PACKAGE 10

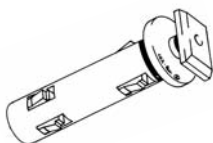
**99-8599**

Replaces: GJ6A-68-162
RETAINER-WINDSHIELD GARNISH MOLDING
 Plastic
 Hole: M10, Head: 10x13MM,
 O/L: 41MM, Trim Thk.: 3MM
 Mazda 3, 5 & RX8 2004/
UNIT PACKAGE 10

**88-6506**

Replaces: GJ150-607, E92Z 6102316A
PIN- COWL SCREEN RETAINER
 Plastic
 Use W/88-6507 & 88-6508 Grommet
 Mazda 626 & MX6 '88/
 Ford Probe '88/
UNIT PACKAGE 25

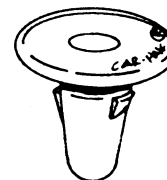
**88-6507**

Replaces: GJ-21-50-H81
GROMMET-COWL SCREEN RETAINER
 R.H. Plastic
 Use W/88-6506 Pin; Round Opening
 Ford Probe '88/
UNIT PACKAGE 25

**88-6508**

Replaces: GJ21-50-H82
GROMMET-COWL SCREEN RETAINER
 L.H. Plastic
 Use W/88-6506 Pin; Oval Opening
 Mazda 626 & MX6 '88/
 Ford Probe '88/
UNIT PACKAGE 25

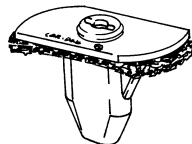
**99-8285**

Replaces: FD02-50-798
GROMMET - COWL VENT
 Plastic w/Seal
 Hole: 7X11MM, Flange: 12X22MM,
 P.R.: 1.5MM, Screw: M4.2(#8)
 Mazda 323, Protege 626,
 MX6 & Millenia '95/
UNIT PACKAGE 10

**87-6211**

Replaces: 90675-SB0-003,
 FB01-56-964 & 63876-95596
RIVET-SCREW TYPE
COWL VENT; FENDER SPLASH SHIELD & AIR DUCTS
 Black Plastic
 Hole: M8, Grip Range: 2.0-5.0MM
 Washer Face 20.0MM
 Honda, Mazda, Nissan '84/
UNIT PACKAGE 10

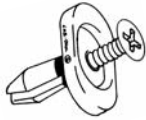
**99-8600**

Replaces: 3M8Z-1502316-A,
GJ6E-50-715A

RIVET-SCREW TYPE, COWL VENT
Plastic

Hole: M5, Flange: 8.5x12MM,
Stem Lgth: 8.7MM, P.R.: 5MM Max
Ford Fusion, Milan & Zephyr 2006
Mazda 5 & 6 2003/
UNIT PACKAGE 15

**94-7319**

Replaces: BO92-51-833, W705845-S300,
86590-28000

**RIVET-SCREW TYPE HEADLAMP
SPLASH SHIELD, COWL VENT**
Plastic

Hole: M8, Flange: 18MM, P.R.: 3-7MM
Ford Probe '89-'92, Escape '01/
Mazda '99/ & Hyundai/Kia
UNIT PACKAGE 25

**95-7463**

Replaces: 90657-SA6-003, 90467-07072,
N304-13-356-B

RIVET-SCREW TYPE, COWL GRILLE
Hole: M7, Washer Head: 14MM
Length: 11MM

Honda Accord '90 - '91, Mazda & Toyota
UNIT PACKAGE 25

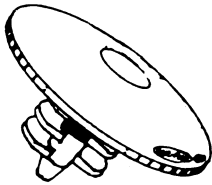
**84-5869**

Replaces: G030-68-885B38

CLIP-HOOD INSULATION

Head Diameter 20MM

Hole: 6MM

Mazda 626 '81-'82, GLC '83/
UNIT PACKAGE 25

**96-7511**

Replaces: F1CZ-16774-A, B455-56-741

CLIP-HOOD INSULATION

Black Plastic

Hole: M6, Length: 10MM,

Head Dia.: 14MM

Ford Probe '88-'92, Mazda MX6 '88-'92
UNIT PACKAGE 25

**86-6063**

Replaces: 67868-89101, G031-58-762

CLIP-WEATHERSTRIP

Plastic

Toyota Car & Truck '83/ & Mazda '86/
UNIT PACKAGE 50

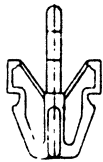
**88-6499**

Replaces: 90467-12020, H200-50-715

BF67-50715, KKY01-50-715

CLIP-GRILLE & HEADLAMP DOOR

Gray Plastic

Toyota Corolla '83/, Chevrolet Nova '86/
Mazda 323 '86/. Ford Festiva & Tracer '88/

Kia Sportage '95/
UNIT PACKAGE 25

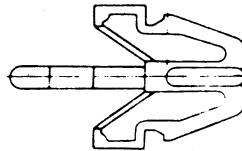
**82-5557**

Replaces: 58974-0008

89421-80270, B092-50-715

CLIP-GRILLE

Mitsubishi, Isuzu, Mazda

UNIT PACKAGE 25

**81-5388**

Mazda No.: 9991-00-403

NUT-HEADLAMP, DOOR & GRILLE

Retainer

Ford Courier Pick-Up Truck

(8 used per truck)

Also Used On Mazda

UNIT PACKAGE 25

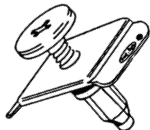
**96-7598**

Replaces: E8BZ-17C756-C

RIVET- SCREW TYPE

Bumper Cover Retainer

Plastic-Black

Hole Dia: M8, Shoulder: 9.5MM

G.R. 3-7MM

Ford Festiva '88/, Mazda 323 '86/
UNIT PACKAGE 10

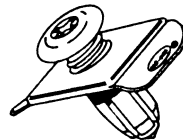
**97-7670**

Replaces: BF67-50-033, MBF67-50-033

RIVET-SCREW TYPE

BUMPER COVER RETAINER

Plastic

Hole: M10, G.R.: 2-7MM

Mazda 323 '86/

Kia

UNIT PACKAGE 10

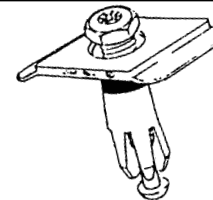
**90-6728**

Replaces: E92Z-17C756-C

GJ21-50-034

RIVET-SCREW TYPE

REAR BUMPER COVER ASSY.

Plastic

Hole: 10, Hex Screw w/Phillips

Type Recess

Ford Probe, Mazda MX6 '89/
UNIT PACKAGE 15

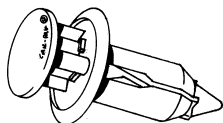
**99-8519**

Replaces: YL8Z-16K262-HC,
GD7A-50-EA1

RIVET-PIN DRIVE TYPE
BUMPER COVER & GRILLE
Plastic

Hole: M10, Flange: 19.5MM,
Stem Lgth:15MM, P.R.: 8.5MM
Ford Mustang 2005/
Mazda Cars & Trucks '99/
UNIT PACKAGE 10

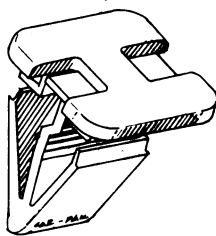
**83-5693**

Replaces: 8871-50-389
CLIP-BODY MOULDING
Mazda
UNIT PACKAGE 25

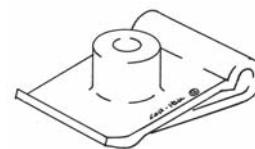
**99-8597**

Replaces: B455-56-135
U-NUT - FRONT BUMPER
Plastic
Screw: M4.8 (#10), Width: 20MM,
Length: 22MM, Throat: 12MM
Mazda Various Models '92/
UNIT PACKAGE 25

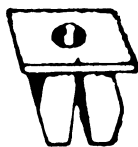
**89-6585**

Replaces: 99910 0501, 14910-05000
GROMMET NUT-ROCKER PANEL,
FRONT BUMPER
Screw M4.2, Hole: 8MM sq.
Plastic
Ford Probe '88, Mazda MX6 '88/
Hyundai '86/
UNIT PACKAGE 50

**99-8598**

Replaces: GJ6A-50-0Z5
GROMMET-FRONT BUMPER
Plastic
Hole: 8.5x12MM Oval,
Flange: 23.5x24MM,
Screw: M4.2 (#8)
Mazda MPV,
3, 5, 6 Miata & RX8 2000/
UNIT PACKAGE 15

**99-8620**

Replaces: BC1M-50-0Z5
GROMMET-FRONT BUMPER
Plastic
Hole: 7x12MM Oval,
Flange: 24x28MM, Screw: M4.2 (#8)
Mazda 323, Protégé, 626,
Miata & MPV '95/
UNIT PACKAGE 10

**76-4295**

Replaces: 97606B0700, 75522-611-000
& 9991-00-412
NUT-SIDE MARKER LAMP
Hole: M6sq., Screw: m3.5
Datsun, Honda, Mazda & General Purpose
UNIT PACKAGE 100

**99-8500**

Replaces: G043-50-742
RETAINER-FENDER APRON
& EXTERIOR TRIM PANELS
Plastic w/Seal
Hole: M8.5, Upper Hd: 14MM,
O/L: 18MM, P.R.: 1.5MM,
Trim Thk: 2.5MM
Mazda Various Models '92/
UNIT PACKAGE 15

**99-8692**

Replaces: G18K-51-SJ3
RETAINER-FENDER & ROCKER
MOULDING, Plastic, W/Seal
Hole: M10, Head Dia: 14MM,
Trim Thk: 2.5MM, O/L: 19MM
Mazda CX-9, 3, 5, 6 MPV,
MX-5/Miata & Protege '99/
UNIT PACKAGE 10

**99-8284**

Replaces: BC1D-56-145
RIVET - DRIVE TYPE
Front Fender Liner & Mud Guards
Plastic
Hole: M8, Flange: 20MM,
Stem Lgth: 9MM, P.R.: 1.5-5.0MM
Mazda 323, Protege, Miata & MPV '95/
UNIT PACKAGE 25

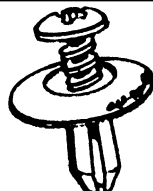
**85-5981**

Replaces: 80915-29A66,
8942-431-900, 9926-50-635
RIVET-SCREW TYPE
Plastic
Hole: M6, Panel Range 2-5MM,
Flange: 20MM
Nissan, Isuzu, Mazda
UNIT PACKAGE 25

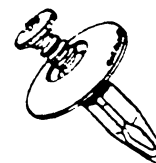
**89-6575**

Replaces: B100 68 675 69
RIVET-SCREW TYPE
VARIOUS TRIM APPLICATIONS
M6 Hole, Head: 20MM P.R. 5-10 MM
Plastic
Ford Probe '88/ Mazda MX6 '88/
UNIT PACKAGE 15

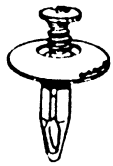

89-6574

Replaces: B040 68 865 A96
RIVET-SCREW TYPE
 REAR COMPARTMENT TRIM
 M6 Hole 15MM Head Dia.. P.R. 4-6 MM
 Plastic
 Ford Probe '88 Mazda Mx6 '88/
 UNIT PACKAGE 25

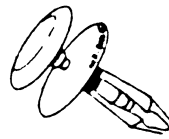

89-6576

Replaces: B101 68 252 00
RIVET- DRIVE TYPE
 INTERIOR TRIM VARIOUS
 M5 Hole, Head Dia.:14 MM P.R. 5-9 MM
 Black Plastic
 Ford Probe '88/, Mazda MX6 '88/
 UNIT PACKAGE 25



89-6579

Replaces: GJ2158 885 A69,
 6E5Z-7850980-AAA (Black)
RIVET-DRIVE TYPE
 INTERIOR TRIM REAR COMPARTMENT,
 FRONT LAMPS
 Hole: M6 , Head Dia.: 18MM, P.R.: 2MM
 Gray Plastic (Paint to Match)
 Ford Fusion, Zepher & Milan 2006/
 Ford Probe, Mazda MX6
 UNIT PACKAGE 25

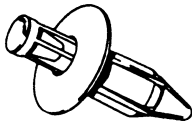

90-6750

Replaces: B100-68-8550
RIVET -DRIVE TYPE
 REARLAMP ACCESS DOOR
 Hole: M8, Washer: 17MM,
 Panel Range 3-5MM
 Black Plastic (Paint to Match)
 Mazda 323 '86/
 UNIT PACKAGE 15

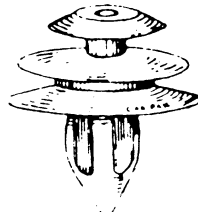

89-6586

Replaces: KA01 68 401, H260-68-401
CLIP-DOOR INTERIOR TRIM PANEL
 Plastic
 Ford Probe '88/ Mazda MX6 '88/
 UNIT PACKAGE 25

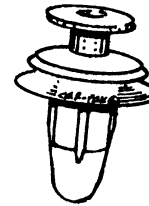

81-5415

Replaces: 67771-12010-F,
 9927-40-825, 894226 4920
 Hole: M8.5, P.R.: 0.80MM
CLIP-TRIM PANEL
 Toyota, Mazda, Isuzu
 UNIT PACKAGE 25



99-8392

Replaces: GA2A-68-AB1A
RETAINER-DOOR PANEL
 Plastic
 Hole:M8.5, O/L: 16MM, Upper Hd.:15MM,
 Trim Thk.:1.8MM, P.R.: 1.8MM
 Mazda 323, Protégé, 626, Miata,
 Mellania, MPV & MX6 '93/
 UNIT PACKAGE 15

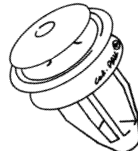

99-8313

Replaces: MG350-68AB1, G350-68-AB1
RETAINER - DOOR & INTERIOR
TRIM PANEL
 Plastic
 Hole: M9, Upper Hd.: 13MM, P.R.: 1MM,
 O/L: 16MM, Trim Thk.: 2MM
 Ford Probe '92/, Mazda '89/ & Kia Rio,
 Sephia & Spectra '98/
 UNIT PACKAGE 10



99-8615

Replaces: GJ6R-68-ABX, GJ6A-68-AB1
RETAINER-DOOR PANEL
 Plastic- w/Seal
 Hole: M8.5, Upper Hd.: 13MM,
 O/L: 18MM,
 P.R.: 2MM, Trim Thk.: 1.8MM
 Mazda 3, 5, 6, Miata & RX-8 2003/
 UNIT PACKAGE 15

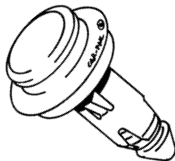

2 PART

99-8430

Replaces: W707593-S300, W708621-S300,
 EC01-68-AB1, 9XG0-75-93X0
RETAINER - DOOR PANEL
 Formerly: 99-8067
 Plastic-2 Piece, Tan Pin, White Grommet
 Hole: M8.5, Upper Hd: 13MM, P.R.:1.2MM,
 O/L: 25MM, Trim Thk.: 2.6MM
 Ford Taurus/Sable 2000/ & Mazda
 UNIT PACKAGE 25



89-6573

Replaces: B003 68 865 96
CLIP-INTERIOR REAR COMPARTMENT
 Hole: M6, Head Dia.: 15MM
 Gray Plastic
 Ford probe '88/, Mazda MX6 '88/
 UNIT PACKAGE 50



89-6580

Replaces: H 001 68 719B
RETAINER-ROCKER SCUFF PLATE
 Plastic
 Ford Probe '88/, Mazda MX6 '88/
 UNIT PACKAGE 25

**89-6584**

Replaces: SO83 68 865A96
**CLIP-INTERIOR TRIM CARPET & SEAT
 BACK**
 Gray Plastic
 Use W/89-6577
 Ford probe '88/, Mazda MX6 '88/
UNIT PACKAGE 25

**89-6577**

Replaces: G032 68 866A
GROMMET-TRIM INTERIOR
 Plastic
 Ford Probe '88/, Mazda MX6 '88
UNIT PACKAGE 25

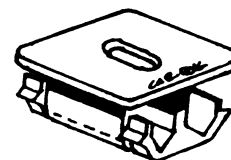
**89-6583**

Replaces: KA01 68 241
CLIP-ROOF GARNISH MOULDING
 Plastic
 Ford Probe '88/ Mazda MX6 '88/
UNIT PACKAGE 15

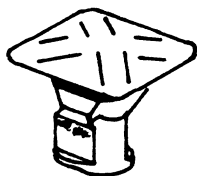
**89-6581**

Replaces: KA01 50 H15
CLIP-REAR HATCH
 Plastic
 Use W/89-6582
 Ford Probe '88/, Mazda MX6 '88/
UNIT PACKAGE 25

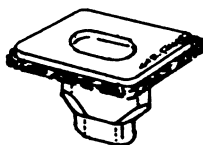
**89-6582**

Replaces: KA01 50 H16
GROMMET REAR HATCH
 Plastic Use w/89-6581
 Ford Probe '88/ Mazda MX6 '88/
UNIT PACKAGE 15

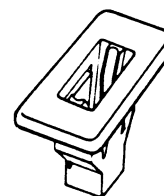
**87-6285**

GROMMET NUT-TAIL LAMP RETAINING
 Plastic Hole 8MM x 12MM
 M5 Screw
 Mazda RX7 '79/
UNIT PACKAGE 10

**76-4295**

Replaces: 97606-B0700, 75522-611-000
 & 9991-00-412
NUT-SIDE MARKER LAMP
 Hole: M6, Screw: M3.5
 Datsun, Honda, Mazda & General Purpose
UNIT PACKAGE 100

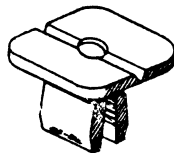
**83-5690**

Replaces: 68425-H5000, 9991-00-503,
 90662-671-0030
GROMMET NUT
 Hole: M8sq., Screw: M4.2
 Datsun, Mazda, Honda & General Purpose
UNIT PACKAGE 25

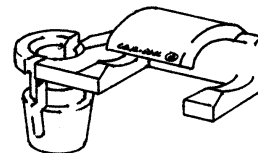
**99-8077**

Replaces: 9927-80-405
CLIP-DOOR LOCK ROD
 Hole: M6.3, Rod: 4MM, P.R.: 2.5MM
 Mazda 323, 626 & 929 '76 / '95
UNIT PACKAGE 25

MISCELLANEOUS JAPANESE PARTS

**72-3643**

CLIP-RETAINER, DOOR PANEL TRIM
 I.D.: 6.7MM, O/L: 15.5MM,
 Flange: 16.4MM
 European & Japanese Cars
UNIT PACKAGE 100

**81-5393**

SCREW-ANCHOR
 Japanese Cars
UNIT PACKAGE 25

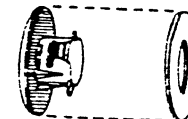
**81-5426**

CLIP & WASHER-CARPET RETAINING
 German & Japanese Cars
UNIT PACKAGE 25

**87-6326**

Replaces: 8-94133167-0
RETAINER-COWL SCREEN
 M3.5 Hole, Head Dia.: 8.0MM
 5.0MM Panel Thickness
 Plastic
 G.M. Spectrum & Isuzu '85/
UNIT PACKAGE 100

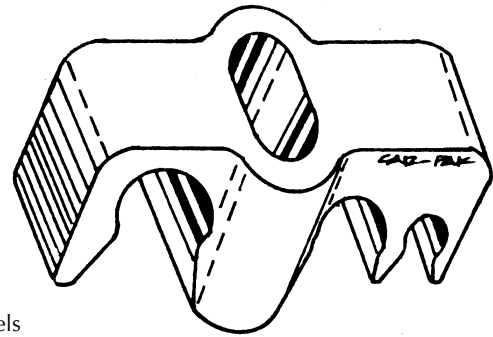
**82-5470**

Replaces: MB 129965
CLIP-FUEL LINES
 Chrysler Products, Japanese Models
 & Mitsubishi Models
UNIT PACKAGE 25

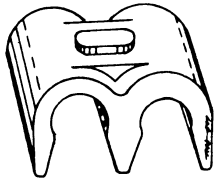
**82-5469**

Replaces: MB 181581
CLIP-WIRE AND TUBING
 Chrysler Products, Japanese Models
 & Mitsubishi Models
UNIT PACKAGE 25

**97-7673**

Replaces: 95008221, 67771-12050,
 67771-16080, 67771-02030,
 67771-12040
RETAINER- DOOR TRIM, HEADLINER
 Plastic
 Hole Dia: M9
 Lexus '96/, Geo, Prism '93/
 Toyota Car & Truck '88/, Scion 2004/
UNIT PACKAGE 50

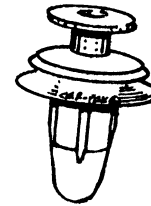
**81-5415**

Replaces: 67771-12010-F,
 9927-40-825, 894226 4920
 Hole: M8.5, P.R.: 0.80MM
CLIP-TRIM PANEL
 Toyota, Mazda, Isuzu
UNIT PACKAGE 25

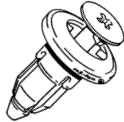
**98-7765**

Replaces: 30008324, 09409-07325
RIVET - DRIVE TYPE
 Radiator Grille, Bumper
 Plastic-Black
 Hole: M7, Flg. Dia: 16MM,
 Stem Lgth: 9MM, Shoulder: 9MM
 Geo Metro 89/98, Suzuki Esteem '95/'97
UNIT PACKAGE 15

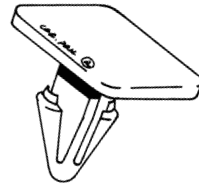
**99-8301**

Replaces: 96057293, 83943-86000
RETAINER - COWL VENT
 Plastic
 Hole: M7, Hd: 12 x 15MM, P.R.: 3MM
 Chevrolet Tracker '99/ & Suzuki Vitera '99/
UNIT PACKAGE 25

**99-8302**

Replaces: 30000784, 09409-05309-5ES
RETAINER - COWL VENT
 Plastic-Textured Head
 Hole: M5, Hd: 14MM, P.R.: 8.5MM
 Chevrolet Tracker '99/ & Suzuki Vitera '99/
UNIT PACKAGE 25

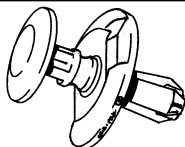
**99-8103**

Replaces: 90467-07164,
 09409-07332, 30020637
RIVET-DRIVE TYPE
 Grille, Bumper, Fender Apron/Flare-Plastic
 Hole: M7, Flange: 20MM,
 Stem Lgth: 10MM
 Toyota Camry, MR2, Sienna & Echo '97/
 Suzuki Gr. Vitera/Vitera, XL7, Ari '99/, G.M.
 Tracker '99/
UNIT PACKAGE 10

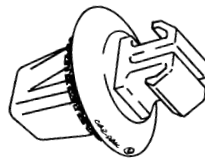
**99-7988**

Replaces: 90467-11063,
 88970493, 77553-65D00
RETAINER-ROCKER PANEL MOULDING
 Plastic
 Hole: M9
 Toyota '90/, Pontiac Vibe 2003/
 Suzuki Gr. Vitera ''-2004
UNIT PACKAGE 15

**72-3638**

Replaces: 9130018
CLIP-FRONT SEAT COVER
 (8 per car)
 Plymouth Cricket
UNIT PACKAGE 50

**72-3639**

Replaces: 79132505
CLIP-HEADLINING
 (10 per car)
 Plymouth Cricket
UNIT PACKAGE 50

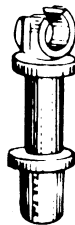
**72-3641**

Replaces: 79132559
CLIP-BRAKE PIPE
 General Purpose Hose Clip
 Plymouth Cricket
UNIT PACKAGE 50

**72-3637**

Replaces: 9132801
CLIP-FRICTION
 Name Plates, Etc.
 (12 per car)
 Plymouth Cricket
UNIT PACKAGE 100

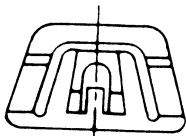
MITSUBISHI & CHRYSLER IMPORT**81-5374**

Replaces: MB-106520,
 90694-SA6-003
CLIP-WINDSHIELD MOULDING
 Honda Accord '82-'83
 Chrysler Arrow, Colt
 Other Japanese Models
UNIT PACKAGE 25

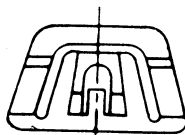
**81-5373**

Replaces: MB-112069
CLIP-WINDSHIELD MOULDING
 White
 Chrysler Arrow, Colt '79-'80 &
 Other Japanese Models
UNIT PACKAGE 25

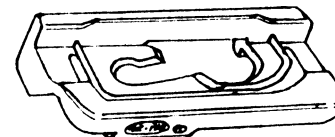
**85-5936**

Replaces: MB-198536
CLIP-WINDSHIELD MOULDING
 Dodge Conquest
 Mitsubishi Satrion '84/
UNIT PACKAGE 25

**97-7742**

Replaces: MB880455
CLIP-WINDSHIELD MOULDING
 Plastic-Light Blue
 Mitsubishi Montero '92/'95
UNIT PACKAGE 10

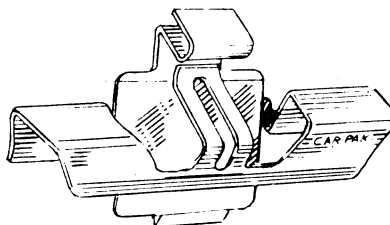
**81-5318**

Replaces: MB-024173
CLIP-WINDSHIELD REVEAL MOULDING
 Dodge Colt & Arrow '78/
UNIT PACKAGE 25

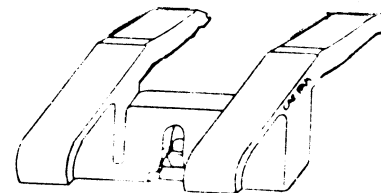
**81-5372**

Replaces: MB-223068
CLIP-WINDSHIELD MOULDING
 Chrysler Arrow, Colt
 Other Japanese Models
UNIT PACKAGE 25

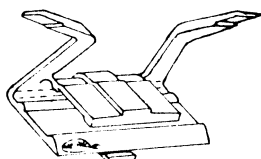
**85-5935**

Replaces: MB-198602
CLIP-WINDSHIELD MOULDING
 (Side)
 Mitsubishi, Coria & Tredia '84/
UNIT PACKAGE 25

**99-8242**

Replaces: MB645307
GROMMET-BACK GLASS LOWER MOULDING, QTR. GLASS MOULDING, SPOILERS
 Plastic w/seal
 Hole: 7x11MM, Flange: 12x16MM,
 O/L: 15MM
 Chrysler Avenger/Sebring '95/
 Stealth '91-'96 & Mitsubishi '91/
UNIT PACKAGE 15

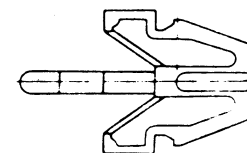
**82-5557**

Replaces: 58974-0008
 89421-80270, B092-50-715
CLIP-GRILLE
 Mitsubishi, Isuzu, Mazda
UNIT PACKAGE 25

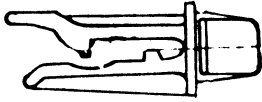
**82-5602**

Replaces: MB-117684
CLIP-GRILLE ATTACHING
 Japanese Cars Imported by Chrysler &
 Mitsubishi
UNIT PACKAGE 25

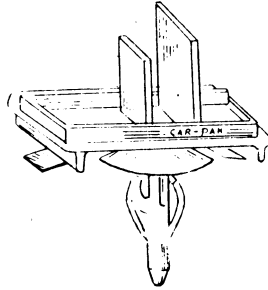
**81-5292**

Replaces: MB-082526
CLIP-ROCKER PANEL MOULDING
 Dodge Colt & Arrow '78/
UNIT PACKAGE 25

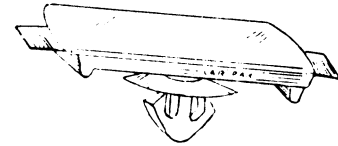
**81-5295**

Replaces: B061622
CLIP-SIDE MOULDING
 Dodge Arrow & Colt '78/
UNIT PACKAGE 25

**82-5462**

Replaces: MB-15280
CLIP-MOULDING
 Chrysler Products, Japanese Models
 Mitsubishi Models
UNIT PACKAGE 25

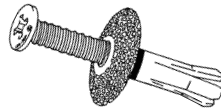
**97-7704**

Replaces: MB888869, 90505-SL0-003,
 90467-08155
RIVET-SCREW TYPE
 Bumper Cover
 Plastic
 Hole: M8, Stem: 20.5MM,
 Panel: 13MM, HD 20MM
 Chrysler, Mitsubishi, Acura, Toyota '93/
UNIT PACKAGE 15

**98-7789**

Replaces: MR138807
RIVET-SCREW TYPE, BUMPER COVER
 Plastic
 Hole: M8, Flange: 20MM
 Max G.R.: 20MM
 Chrysler Sebring '96/
 Mitsubishi Eclipse '94/
UNIT PACKAGE 5

**91-6953**

Replaces: 63854-01A00, MB547806
RIVET-SCREW TYPE, BUMPERS
 Plastic Textured Finish
 Hole: M8, Washer Face: 20MM
 G.R.: 4MM-8MM
 Nissan 300ZX '90/, Chrysler
 & Mitsubishi '90/
UNIT PACKAGE 15

**90-6806**

Replaces: 96057846, 09409-07308
 MB475404, 90467-07076
RIVET-DRIVE TYPE (Removeable)
 COWL, FRONT BUMPER
 Plastic
 Hole: M6, Washer: 15MM, P.R.: 2-5MM
 Toyota Rav 4, G.M. Geo Tracker '89/
 Chrysler & Mitsubishi '95/ Suzuki '89/
UNIT PACKAGE 10

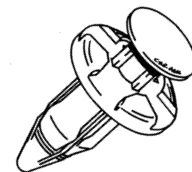
**98-7854**

Replaces 01553-0932, MR3289541
RIVET-DRIVE TYPE (REUSABLE)
 Plastic-Front Fender & Bumper
 Hole: M8, Flange: 20MM, P.R.: 4MM
 Nissan '94/, Infinity '93/
 & Chrysler/Mitsubishi '99/
UNIT PACKAGE 15

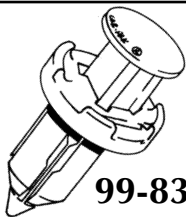
**99-8316**

Replaces: MR200300
RIVET - DRIVE TYPE
 Bumper Cover & Interior Trim
 Plastic
 Hole: M9, Flange: 18MM,
 Stem: 13MM, P.R.: 7MM
 Chrysler Sebring & Stratus 2001/
 Mitsubishi '97/
UNIT PACKAGE 25

**99-8315**

Replaces: MR478262
RIVET - DRIVE TYPE
 Bumper Cover & Garnish Moulding
 Plastic w/Textured Head, Use w/99-8314
 Hole: M7, Head: 15MM,
 Flange: 14MM, Stem: 13MM
 Chrysler Sebring & Stratus 2001/
 Mitsubishi Eclipse 2000/
UNIT PACKAGE 15

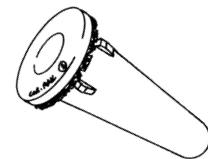
**99-8314**

Replaces: MR478263
GROMMET - BUMPER COVER &
GARNISH MOULDING
 Rubber w/Seal, Use w/99-8315
 Hole: M9, Flange: 15.5MM,
 O/L: 21.5MM, P.R.: 1.5MM
 Chrysler Sebring & Stratus 2001/
 Mitsubishi Eclipse 2000/
UNIT PACKAGE 15

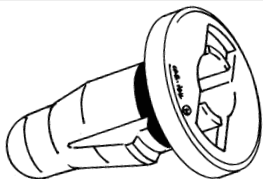

99-8250

Replaces: MB271999
RETAINER - BUMPER COVER
 Plastic
 Hole: M13, Flg: 24MM, O/L: 24MM
 Chrysler Colt, Sebring/Stratus '89/
 Eagle '89-96
 Mitsubishi Eclipse, Galant, Mirage '93/
UNIT PACKAGE 10

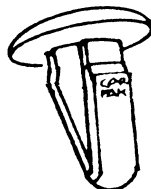

81-5377

Replaces: MB-132160
TRIM CLIP
 Tan
 Chrysler Arrow, Colt
 Other Japanese Models
UNIT PACKAGE 25



99-8147

Replaces: 90667-671-013ZA,
 62660-48600-1, MC440901
CLIP-INTERIOR TRIM
 Plastic - Textured Head
 Hole: M6, Head: 15.5MM, P.R.: 7MM,
 Stem Length: 15.5MM
 Honda, Nissan & Mitsubishi
UNIT PACKAGE 25

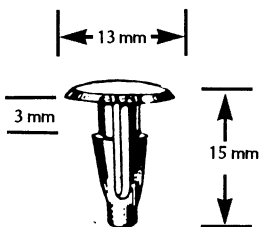

82-5465

Replaces: MB 178893
 Black

82-5467

Replaces: MB 178896
 Light Blue

82-5468

Replaces: MB 178899
 Off White

UPHOLSTERY AND TRIM CLIPS

Chrysler Products, Japanese Models
 Mitsubishi Models
 5mm Hole Size
UNIT PACKAGE 25

81-5378

Replaces: MB 178894
 Blue

82-5471

Replaces: MB 222647
 Burgundy



97-7722

Replaces: MB361578
GROMMET-FENDER MOULDING
 Plastic-W/Sealer
 Hole: 8 X 11MM, Face: 17MM Sq, Use
 M4.2 Screw
 Chrysler & Mitsubishi '97/
UNIT PACKAGE 10



81-5363

Replaces: MB-091438
NUT
 Chrysler Products, Colt & Arrow Models
UNIT PACKAGE 50

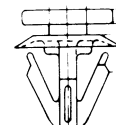

99-8485

Replaces: MB-132135
CLIP-TRIM PADS
 Formerly 81-5376
 Chrysler Arrow, Colt
 Other Japanese Models
UNIT PACKAGE 25

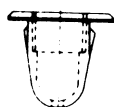

81-5379

Replaces: MB-132162
CLIP-TRIM
 Chrysler Arrow, Colt
 Other Japanese Models
UNIT PACKAGE 25



72-3621

Replaces: 2117899
LINKAGE CLIP-REAR DOOR
 (4 per car)
 Plymouth Cricket
UNIT PACKAGE 50

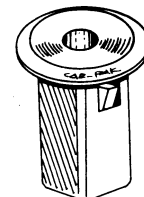

83-5705

Replaces: 90189-06005,
 098-145, 01281-00023
CLIP-BODY MOULDING
 M.6.3 Screw
 Toyota, Mitsubishi, Datsun
UNIT PACKAGE 25



76-4334
Replaces: 90189-05013
MS-480-002
**NUT-HEADLAMP BEZEL
& GRILLE**
Toyota, Mitsubishi
UNIT PACKAGE 100

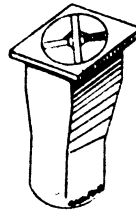

81-5385
Replaces: 96706-89901
9991-00-402
GROMMET NUT-ANCHOR TYPE
Datsun, Mazda, Mitsubishi
UNIT PACKAGE 25



99-8484
Replaces: MS-480003
GROMMET NUT-GENERAL PURPOSE
Formerly 81-5375
Chrysler Arrow, Colt
Other Japanese Models
UNIT PACKAGE 25

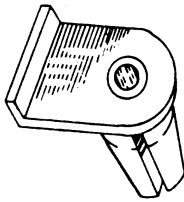

82-5473
Replaces: MB-174570
SCREW GROMMET
Chrysler Products
Japanese Models & Mitsubishi Models
UNIT PACKAGE 25

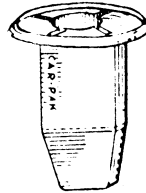

81-5293
Replaces: 01651-00481
MS 480012
CLIP-GENERAL PURPOSE
9mm Sq. Hole
Toyota, Mitsubishi '78/
UNIT PACKAGE 25



82-5461
Replaces: 96706-K1300, 90672-671-811,
MB106212, 790184000
SCREW-ANCHOR
Hole: M7sq., Screw M4.2
Datsun 8310, Honda, Mitsubishi, Subaru
UNIT PACKAGE 25

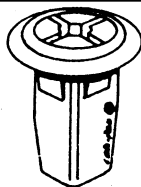

87-6324
Replaces: 01281-00023, 90189-06001,
MB098145
GROMMET NUT
Plastic
M.S. Screw; M8.5, Head Dia.: 18MM
Nissan Applications '86/
Toyota & Mitsubishi
UNIT PACKAGE 25

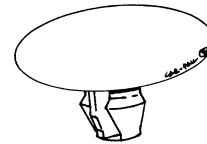

97-7692
Replaces: MB020923, MU 481187
**RETAINER- HOOD INSULATION,
DOOR PANEL**
Plastic-Paint to match
Hole Dia: 8MM, Head Dia: 26MM
Chrysler, Eagle '92/
UNIT PACKAGE 10

NISSAN / DATSUN

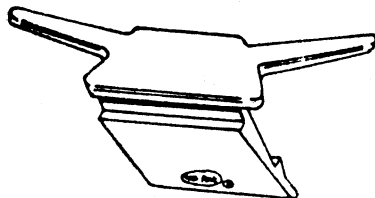

84-5880
Replaces: 72826-01P00
CLIP-WINDSHIELD MOULDING
Plastic
Nissan 300 ZX '84/
UNIT PACKAGE 25

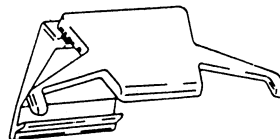

91-6907
Replaces: 73856-51E00
CLIP-ROOF SIDE MOULDING
Plastic
Nissan Stanza '90/
UNIT PACKAGE 25

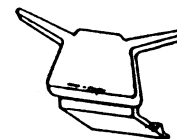

91-6951
Replaces: 72796-30P00
CLIP-WINDSHIELD MOULDING SIDE
Plastic
Nissan 300 ZX '90/
UNIT PACKAGE 15

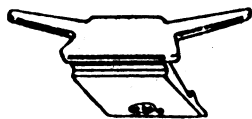
**91-6950**

Replaces: 79796-71E00
CLIP-BACK GLASS MOULDING
 Plastic
 Nissan Maxima '90/
UNIT PACKAGE 25

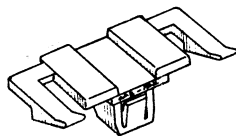
**83-5686**

Replaces: 80866-01A00
**CLIP-WINDSHIELD
 REVEAL MOULDING**
 Nissan
UNIT PACKAGE 25

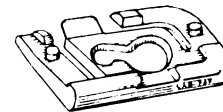
**79-4988**

Replaces: 72825-47400
**CLIP-WINDSHIELD
 REVEAL MOULDING**
 Nissan 710, 200SX '74-'79 & Mazda
UNIT PACKAGE 50

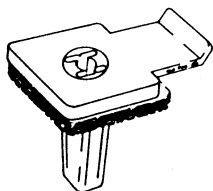
**91-6948**

Replaces: 76848-85E10
GROMMET w/SEALER
WINDSHIELD SIDE MOULDING
 Plastic M4 Screw
 Nissan Maxima '90/
UNIT PACKAGE 15

**76-4288**

Replaces: 01553-00171
**CLIP-SIDE WINDOW BEADING
 MOULDING**
 Nissan '73
UNIT PACKAGE 50

**76-4289**

Replaces: 79825-U0100
**CLIP-REAR WINDOW BOTTOM
 MOULDING**
 Nissan Model 610, '73/
UNIT PACKAGE 50

**91-6900**

Replaces: 01553-03361
**GROMMET-WINDSHIELD
 MOULDING RETAINER**
 Lower Corner Moulding (Use w/91-6901)
 Plastic
 Nissan Pathfinder '90/
UNIT PACKAGE 15

**91-6901**

Replaces: 01553-03371
RETAINER-WINDSHIELD MOULDING
 Lower Corner Moulding (Use w/91-6900)
 Plastic
 Nissan Pathfinder '90/
UNIT PACKAGE 25

**91-6949**

Replaces: 80874-85E00, 80874-3Z600
GROMMET-COWL GRILLE
 Plastic w/Sealer
 Use w/92-7012
 Nissan Maxima '90/, Altima '93/ &
 Infinity '96/
UNIT PACKAGE 15

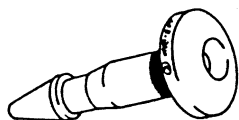
**92-7012**

Replaces: 66820-88E00
CLIP-COWL SCREEN
 Plastic Use w/91-6949 or 99-8463
 Head Dia.: 10MM, O/L: 18MM
 Nissan Maxima '90/, Altima '93/ &
 Infinity '96/
UNIT PACKAGE 25

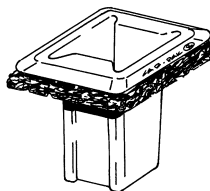
**99-8463**

Replaces: 80874-0P000
GROMMET-COWL VENT
 Plastic w/Seal, use w/92-7012
 Hole: M8 sq., Flange: 13MM, O/L: 14MM,
 P.R: 1MM
 Nissan & Infinity '97/
UNIT PACKAGE 15

**99-8436**

Replaces: 66820-3S500-C1
RETAINER-COWL VENT
 Plastic - use W/91-6949
 Upper Head: 12.7MM, Stem Lgth: 13MM,
 O/L: 18.5MM, Trim Thk: 2.7MM
 Nissan Frontier & Xterra '98/
UNIT PACKAGE 25

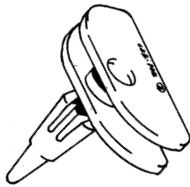
**99-8433**

Replaces: 66820-3S510
RETAINER-COWL VENT
 Plastic
 Hole: M5, Head: 10 x 18MM,
 O/L: 18.6MM, Trim Thk: 3MM
 Nissan Frontier & Xterra '98/
UNIT PACKAGE 25

**91-6954**

Replaces: 01553-01781
RETAINER-COWL GRILLE
 Hole: M5 Head Dia.: 12MM
 O/L: 15MM
 Plastic
 Nissan 240 SX '90/
UNIT PACKAGE 25

**99-8495**

Replaces: 01553-01182
RETAINER-COWL & FENDER APRON
 Plastic-Textured
 Hole: M5, Head: 15MM,
 Stem Lgth: 14MM, P.R.: 2-9MM
 Nissan Altima, Frontier, Quest,
 Xterra & Pick Up '86/
UNIT PACKAGE 25

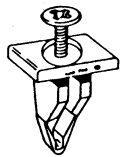
**91-6952**

Replaces: 66814-01A00
RIVET-SCREW TYPE, COWL GRILLE
 Plastic
 Hole: M6 Sq. Head: 8MM x 12MM
 G.R.: 5M-7MM
 Nissan 300 ZX '90/
UNIT PACKAGE 25

**87-6211**

Replaces: 90675-SB0-003,
 FB01-56-964 & 63876-95596
RIVET-SCREW TYPE
 COWL VENT; FENDER SPLASH
 SHIELD & AIR DUCTS
 Black Plastic
 Hole: M8, Grip Range: 2.0-5.0MM
 Washer Face 20.0MM
 Honda, Mazda, Nissan '84/
UNIT PACKAGE 10

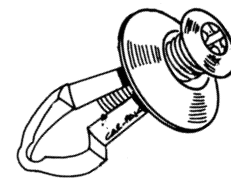
**83-5741**

Replaces: 66860-01W01
RIVET-COWL PANEL TO
REINFORCEMENT PLATE
 Hole: M6, Panel Range 2-8MM
 Washer Face: 14MM
 Black High Gloss Finish
 Nissan '80/, Infinity '91/
UNIT PACKAGE 25

**87-6197**

Replaces: 66814-01G00
DRIVE RIVET-
COWL GRILLE RETAINER
 Hole: 5MM Sq., Panel Range 1.0-4.0MM
 Rectangular Face: 8.0 x 12.0MM
 Plastic
 Nissan Pick-up & Pathfinder '86-'97
UNIT PACKAGE 25

**95-7462**

Replaces: 91545-SE0-003
 & 63848-01G00-A
RIVET-DRIVE TYPE, COWL GRILLE
 Hole: M8, Washer Head: 20MM
 Length: 14MM
 Honda Accord '90/, Nissan Trucks '87/
 Maxima thru '98
UNIT PACKAGE 15

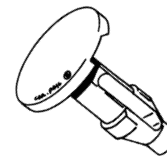
**99-8147**

Replaces: 90667-671-013ZA,
 62660-48600-1, MC440901
CLIP-INTERIOR TRIM
 Plastic - Textured Head
 Hole: M6, Head: 15.5MM, P.R.: 7MM,
 Stem Length: 15.5MM
 Honda, Nissan & Mitsubishi
UNIT PACKAGE 25

**76-4333**

Replaces: 90467-07050
 & 01553-00172
CLIP-WEATHERSTRIP & TRIM PANEL
 Hole: M5
 Nissan
UNIT PACKAGE 100

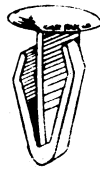
**81-5386**

Replaces: 76906-T3000
 & 90467-11005
CLIP-WEATHERSTRIP
 Hole: M6, Head: 14MM, Stem
 Lgth: 16MM, O/L: 18MM
 Nissan, Honda
UNIT PACKAGE 50

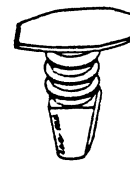
**82-5506**

Replaces: 90664-671-003,
 91530-SH4-003
CLIP-WEATHERSTRIP
 Plastic-White
 Hole: M5, Head: 6.6x16MM, O/L: 14MM
 Nissan, Honda
UNIT PACKAGE 50

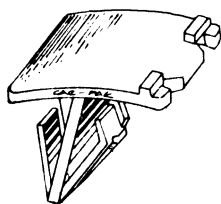
**82-5538**

Replaces: 80866-H8200
CLIP-ROD END
 Nissan
UNIT PACKAGE 50

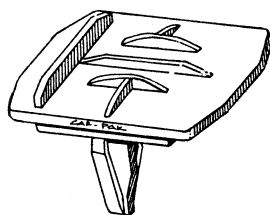
**83-5695**

Replaces: 11255150
CLIP-BODY MOULDING
 Nissan
UNIT PACKAGE 25

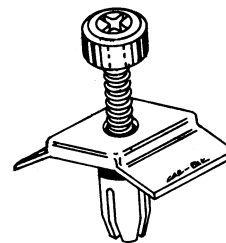
**83-5735**

Replaces: 66824-W1000
CLIP w/SCREW-HOOD MOULDING
 Nissan
UNIT PACKAGE 25

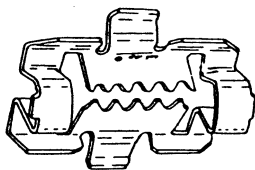
**90-6801**

Replaces: 62228-61A00
RETAINER-FRONT BUMPER CUSHION
 Metal
 Nissan Sentra '87/ & Infinity Q45 '91/
UNIT PACKAGE 15

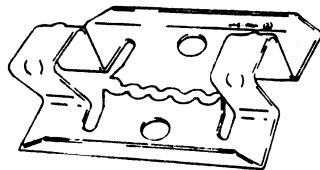
**95-7492**

Replaces: 62228-51S00
RETAINER-FRONT BUMPER
 Metal
 Nissan 300ZX '89/
UNIT PACKAGE 10

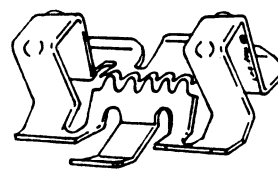
**95-7493**

Replaces: 62228-65E00
CLIP-FRONT BUMPER
 Metal
 Nissan Stanza '90 - '94
UNIT PACKAGE 10

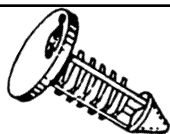
**96-7577**

Replaces: 01644290, 15678979,
 01553-0075U
**RETAINER-SPEAKER, DOOR SILL,
 BUMPER, HOOD INSULATOR**
 Black Plastic
 Hole: M6, Barb Length: 12MM
 Head Dia.: 11MM, O/L: 19MM
 G.M. Various Models '86/
 Nissan Altima & Maxima 2002/
UNIT PACKAGE 50

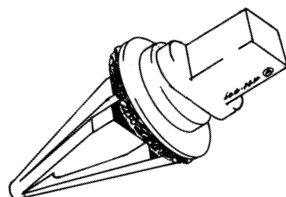
**99-8464**

Replaces: 85284-AD005
RETAINER-REAR BUMPER
 Plastic, w/Seal
 Hole: M10.5 Slot, Flange: 18MM,
 O/L: 38.5MM, P.R.: 1.7MM
 Nissan Quest 2004
UNIT PACKAGE 10

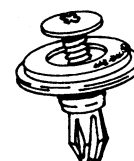
**88-6449**

Replaces: 01553-03101
RIVET-SCREW TYPE
 Bumper & Fascia Attachments
 Plastic
 Hole: M8, Panel Range 2-10MM
 Washer Head: 22MM w/11MM Shoulder
 Nissan '86/
UNIT PACKAGE 25

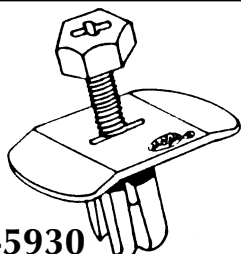
**85-5930**

Replaces: 63844-D0100
 & 894-221-50-0
CLIP w/SCREW
 Hole: M8
 Various Front End Applications
 Nissan, Isuzu, GEO
UNIT PACKAGE 25

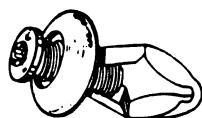
**95-7491**

Replaces: 01553-02741, 01553-03201
RIVET-SCREW TYPE
 Front & Rear Bumper
 Plastic, Black High Gloss Finish
 Hole: M8, Panel Range: 2-5MM
 Head: 22MM
 Shoulder: 11MM x 4MM
 Nissan, Various Models '82 - '94
UNIT PACKAGE 10

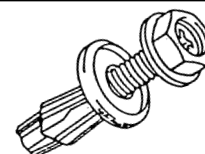
**91-6994**

Replaces: 91516-SK7-013, 01553-034U
**RIVET-SCREW TYPE FRONT
 SPLASH SHIELD, BUMPER**
 Hex Drive w/Phillips Recess
 Hole: M8, Washer: 20MM, A/F: 10MM
 Plastic
 Honda Civic '92/ &
 Nissan Quest, Extera, Frontier '99/
UNIT PACKAGE 10

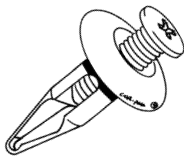
**99-8303**

Replaces: 63878-01E10
RIVET - SCREW TYPE, BUMPER COVER
 Plastic
 Hole: M8, Flange: 20MM, P.R.: 9MM
 Nissan Maxima & Quest '94/
UNIT PACKAGE 15

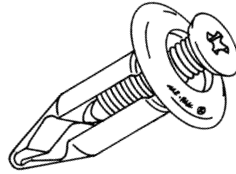
**99-8434**

Replaces: 63848-40Y00
RIVET-FRONT BUMPER
 Plastic
 Hole: M9, Flange: 18MM,
 Stem Lgth: 20MM,
 P.R.: 4-6MM
 Nissan Frontier & Xterra '98/
UNIT PACKAGE 15

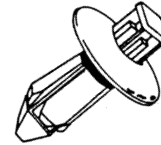
**91-6918**

Replaces: 01553-06721
RIVET-DRIVE TYPE
FRONT & REAR BUMPER COVERS
 Plastic
 Hole: M8, Washer Face: 19MM
 G.R.: 3-6MM
 Nissan Maxima '90/
 Infinity Q45 (Rear) '90/
UNIT PACKAGE 15

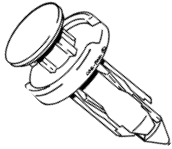
**98-7766**

Replaces: 01553-09241, 57728AC090
RETAINER - BUMPER, MUD GUARD
 Plastic
 Hole: M10, Stem Lgth: 18MM,
 Flange: 18MM
 Nissan Maxima & 240SX '94/
 & Subaru '95/
UNIT PACKAGE 10

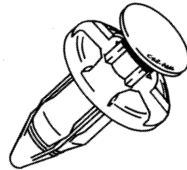
**98-7854**

Replaces 01553-0932, MR3289541
RIVET-DRIVE TYPE (REUSABLE)
 Plastic-Front Fender & Bumper
 Hole: M8, Flange: 20MM, P.R.: 4MM
 Nissan '94/, Infinity '93/
 & Chrysler/Mitsubishi '99/
UNIT PACKAGE 15

**95-7423**

Replaces: 66824-01G00
RIVET-DRIVE TYPE
 Plastic-Black
 Hole: M6, Head: 12MM
 G.R.: 2-4MM
 Nissan-Various Applications
UNIT PACKAGE 15

**98-7770**

Replaces: 90467-09139
 01553-03803
RIVET-DRIVE TYPE, FRONT BUMPER
 Plastic
 Hole: M9, Washer Dia: 18MM
 Stem Length: 12MM
 Toyota Corolla '95/, Nissan
UNIT PACKAGE 10

**99-8273**

Replaces: 622A2-9E000, 622A2-9E000A
RIVET - DRIVE TYPE
 Front Bumper
 Plastic
 Hole: M8, Flange: 26.4MM,
 Stem Length: 29MM, P.R.: 18-21MM
 Nissan Altima '97/
UNIT PACKAGE 15

**99-8275**

Replaces: 01553-09611,
 01553-10501, 90467-08185
RETAINER - DRIVE TYPE
 Grille, Bumpers, Trunk Trim
 Plastic
 Hole: M8, Flange: 18MM
 Stem Length: 10MM, P.R.: 6.3MM
 Nissan Maxima, Sentra '94/
 Infinity G20, I35, Q45 '99/
 Lexus & Toyota '97/, Scion 2004/
UNIT PACKAGE 15

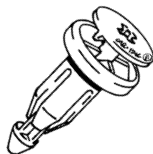
**99-8340**

Replaces: 01553-01733
RIVET - PIN DRIVE (Twist to Release)
 BELT MOULDING
 Plastic - Textured
 Hole: M6, Flange: 14MM,
 Stem Lgth: 9MM, P.R.: 3-6MM
 Nissan Altima 2002/
UNIT PACKAGE 15

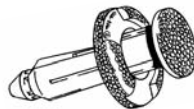
**99-8494**

Replaces: 11296-AG000
RIVET-DRIVE TYPE (Re-usable)
 Front Bumper & Radiator Support
 Plastic - Textured
 Hole: M8, Flange: 20MM,
 Stem Lgth: 13MM. P.R.: 2-6MM
 Nissan Altima, Maxima & Quest 2002/
 Infinity FX35/45 2003/
UNIT PACKAGE 25

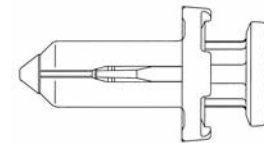
**99-8554**

Replaces: 63848-9E001
RIVET-DRIVE TYPE
 Bumper Cover
 Plastic
 Hole: M9, Flange: 18MM,
 O/L: 33.5MM, P.R.: 12MM Max.
 Nissan Altima & Xterra 1998/
UNIT PACKAGE 15

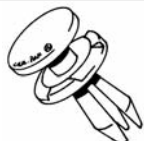
**99-8756**

Replaces: 66820-AX020
RIVET-DRIVE TYPE, COWL VENT & OUTSIDE MIRROR
 Plastic, Textured
 Hole: M6, Flange: 14MM,
 Head: 13.5MM, Stem Lgth: 10MM,
 P.R.: 5MM Max
 Nissan Versa & Pathfinder 2005/
UNIT PACKAGE 10

**99-8755**

Replaces: 01553-05323
RIVET-DRIVE TYPE, COWL, BUMPER, FENDER LINER & ENGINE UNDER COVER - Plastic, Textured
 Hole: M8, Flange: 20MM,
 Stem Lgth: 12MM, P.R.: 2-6MM
 Infinity FX35/45, G35 2003/
 Nissan Cars & Trucks 2004/
UNIT PACKAGE 10

**99-8792**

Replaces: 01553-09431
RIVET-DRIVE TYPE, FRONT BUMPER
 Plastic, Dark Grey
 Hole: M8, Flange: 20MM,
 Stem Lgth: 11MM, P.R.: 1-6.2MM
 Nissan Maxima 2004-2008
UNIT PACKAGE 15

**86-6017**

SCREW-PHILLIPS WASHER HEAD
 Type 'B' M5 x 9MM w/15MM Dia.
 Washer Head
 Black Finish
 Rubber Bumper Strip Bracket
 Nissan
UNIT PACKAGE 100

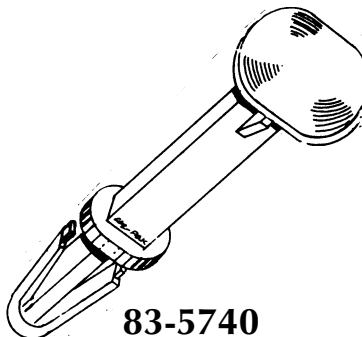
**83-5740**

Replaces: 62089-N8520
RETAINER-BUMPER COVER
 Nissan '80/
UNIT PACKAGE 25

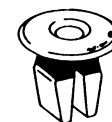
**91-6956**

Replaces: 01281-00441
GROMMET-FRONT BUMPER APRON
 Plastic
 M5/6 Screw, Hole: 8MM Sq.
 Nissan Stanza '90
UNIT PACKAGE 25

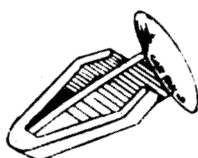
**91-6955**

Replaces: 01553-00545
RETAINER-REAR BUMPER FASCIA
 Plastic
 M6 Hole, Head Dia. 14MM
 O/L: 17MM
 Nissan Sentra '90/
UNIT PACKAGE 25

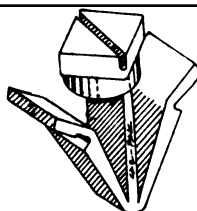
**82-5539**

Replaces: 62318-H8500
 & 01553-03831
CLIP-GRILLE RETAINER
 Black
 Nissan Maxima Stanza '90/
 Nissan '82
UNIT PACKAGE 50

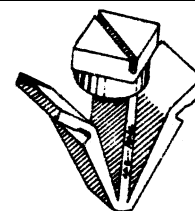
**85-5940**

Replaces: 62318-01W00
 & 01553-05751
CLIP-GRILLE ATTACHING
 Dark Gray
 Nissan Sentra '90/
 Nissan '85/
UNIT PACKAGE 50

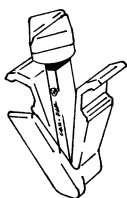
**99-8344**

Replaces: 76882-0M060
RETAINER - FRONT BUMPER & RADIATOR GRILLE
 Plastic
 Nissan '95/ & Infinity 2002/
UNIT PACKAGE 10

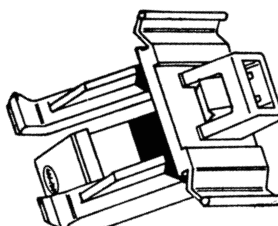
**83-5748**

Replaces: 62350-M7060
CLIP-GRILLE
 Plastic
 Nissan 310 Models w/Rectangle
 Headlights '81 - '82
UNIT PACKAGE 10

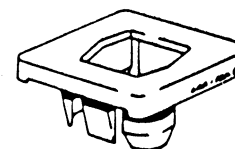
**92-7096**

Replaces: 62380-U7400
CLIP-GRILLE RETAINING
 Plastic
 Hole: 12MM x 16MM
 Nissan Pathfinder & Sentra '87/
UNIT PACKAGE 10

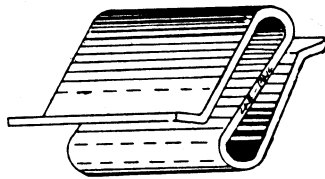
**82-5562**

Replaces: 63812-U7400
CLIP-FENDER ATTACHING
 Plastic
 Nissan
UNIT PACKAGE 25

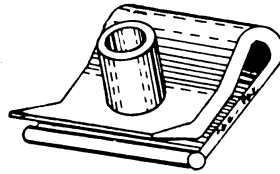
**82-5563**

Replaces: 63848-D0100
CLIP-FENDER ATTACHING
 Plastic
 Hole: M5
 Nissan
UNIT PACKAGE 25

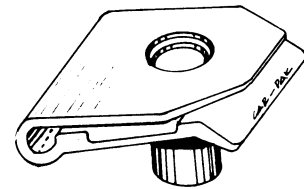
**83-5706**

CLIP-GENERAL USAGE
 Black, M5 Hole
 Nissan/Toyota
UNIT PACKAGE 25

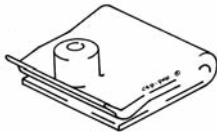
**99-8685**

Replaces: 76882-0M000
U-NUT-FENDER
 Plastic
 Screw: M4.8(#10), Width: 20MM,
 Length: 20.5MM, Throat: 8MM
 Nissan '95/ & Infinity '96/
UNIT PACKAGE 15

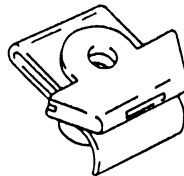
**92-7097**

Replaces: 63848-D4000
CLIP-INNER FENDER PANEL
 Plastic
 Hole: M6
 Nissan & Infinity Models '89/
UNIT PACKAGE 15

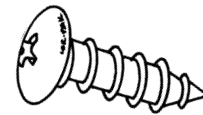
**97-7634**

Replaces: 08540-61608
SCREW- PHILLIPS TRUSS HEAD
 M6 x 15MM
 Head Dia: 13.5MM, Black Finish
 Use with 92-7097
 Nissan '88/
UNIT PACKAGE 50

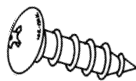
**97-7635**

Replaces: 01451-00841
SCREW- PHILLIPS TRUSS HEAD
 M5 x 15MM
 Head Dia: 13.8MM
 Black Finish
 Ford Windstar & Nissan '85/
UNIT PACKAGE 50

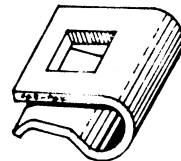
**82-5576**

Replaces: 63846-M6800
CLIP-SHEET METAL RETAINING
 Plastic
 Nissan
UNIT PACKAGE 25

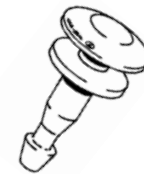
**97-7735**

PIN-WHEEL FLARE
 Plastic
 Flare Assy # 63810-0W600
 Use With Grommet 97-7734
 Nissan Pathfinder '97/
UNIT PACKAGE 15

**97-7734**

Replaces: 01553-02923
GROMMET-WHEEL FLARE
 Plastic
 Flare Assy. # 63810-0W600
 Use with Pin 97-7735
 Nissan Pathfinder '97/
UNIT PACKAGE 15

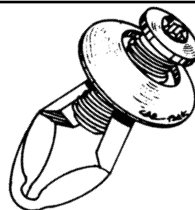
**83-5742**

Replaces: 63844-01A00
RIVET-INNER FENDER SHIELD
 Hole: M8, Panel Range 2-8MM
 Flange: 20MM
 Black High Gloss Finish
 Nissan
UNIT PACKAGE 25

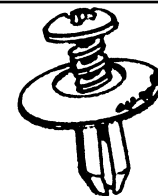
**85-5981**

Replaces: 80915-29A66,
 8942-431-900, 9926-50-635
RIVET-SCREW TYPE
 Plastic
 Hole: M6, Flange: 20MM, P.R. 2-5MM
 Nissan, Isuzu, Mazda &
 General Purpose
UNIT PACKAGE 25

**91-6953**

Replaces: 63854-01A00, MB547806
RIVET-SCREW TYPE, BUMPERS
 Plastic Textured Finish
 Hole: M8, Washer Face: 20MM
 G.R.: 4MM-8MM
 Nissan 300ZX '90/, Chrysler
 & Mitsubishi '90/
UNIT PACKAGE 15

**90-6814**

Replaces: 84948-11A00
RIVET-SCREW TYPE
 INTERIOR TRIM PANEL
 Tan Plastic (Paint to Match)
 Hole: M6, Flange: 12MM, P.R. 7-9MM
 Nissan Sentra '82/
UNIT PACKAGE 25

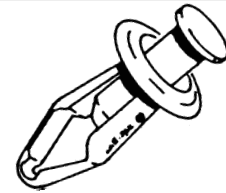
**90-6800**

Replaces: 76882-57A00
RIVET-DRIVE TYPE
 BODY SIDE MOULDING RETAINER
 Plastic
 Hole: M8, Flange: 16MM
 P.R.: 4-8MM
 Nissan Sentra '86/
UNIT PACKAGE 10

**96-7526**

Replaces: 01553-00755, 80999-05N07,
 90467-07043
RIVET-DRIVE TYPE, DECK TRIM
 Hole: 7MM Head Dia.: 18MM
 Stem Length: 11MM
 Nissan, Toyota
UNIT PACKAGE 15

**76-4361**

Replaces: 90467-06054
RIVET-TRIM PANELS
 Black Plastic
 Nissan
UNIT PACKAGE 100

**83-5688**

Replaces: 76913-N9900
CLIP-GENERAL USAGE
 Black
 Hole: M6, Head: 12MM
 O/L: 16MM
 Nissan
UNIT PACKAGE 50

**82-5535**

Replaces: 01553-00541
CLIP-TRIM
 Black
 Hole: M5, Head: 12MM,
 Stem Lgth.: 14MM
 Nissan
UNIT PACKAGE 50

**83-5687**

Replaces: 01553-01251
CLIP
 Plastic
 General Usage
 Nissan
UNIT PACKAGE 25

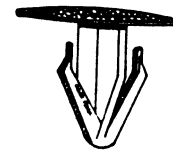
**81-5416**

Replaces: 01553-00051
CLIP-TRIM PANEL
 Nissan
UNIT PACKAGE 25

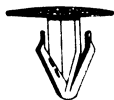
**82-5569**

RIVET-DUMMY BUMPER BOLT
 Chrome Plated
 Nissan
UNIT PACKAGE 25

**99-8435**

Replaces: 01553-0052U
RETAINER-FRONT DOOR PANEL
 Plastic - Textured
 Hole: M8, Head: 20MM,
 Stem Lgth: 15MM, P.R.: 3.5-4MM
 Nissan Frontier & Xterra 2000/
UNIT PACKAGE 25

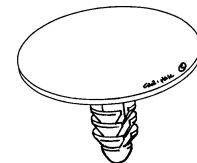
**99-8343**

Replaces: 65846-40F00
RETAINER - HOOD INSULATOR
 Plastic
 Hole: M5, Flange: 28MM,
 Stem Lgth: 10MM, O/L: 12MM
 Nissan '93/ & Infinity '89/
UNIT PACKAGE 15

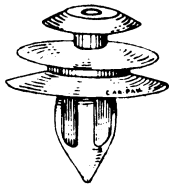

79-4987
CLIP-DOOR TRIM PANEL
 Nissan
UNIT PACKAGE 50

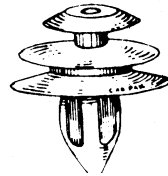

82-5536
 Replaces: 01553-00542
CLIP-TRIM
 Nissan
UNIT PACKAGE 50

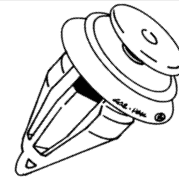

99-8341
 Replaces: 01553-07111
RETAINER - DOOR PANEL
 Plastic
 Hole: M8, Upper Head 13MM,
 Trim Thk: 3MM, O/L: 20MM, P.R.: 1.5MM
 Nissan Altima 2002/ &
 Infinity Q45, G35 '97/
UNIT PACKAGE 15

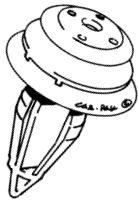

99-8342
 Replaces: 01553-09791
RETAINER - DOOR PANEL
 Plastic
 Hole: M8, Upper Hd.: 13MM,
 Trim Thk: 2.5MM, O/L: 20MM, P.R.: 1.5MM
 Nissan 2000/ & Infinity '99/
UNIT PACKAGE 15



85-5958
 Replaces: 01553-S3500
CLIP-DOOR TRIM PANEL
 Nissan Trucks
UNIT PACKAGE 50



85-5991
 Replaces: 90684-SA5-003,
 10998-30880, 874-298-1190
RIVET- SCREW TYPE HEADLAMP
HOUSING TO GRILLE, Plastic
 Hole: M5, Washer Head: 15MM
 Grip Range: 2.0MM - 6.0MM
 Honda Accord '84/
 Nissan: Isuzu, Various Applications
UNIT PACKAGE 25

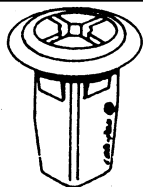

87-6324
 Replaces: 01281-00023, 90189-06001,
 MB098145
GROMMET NUT
 Plastic
 M.S. Screw; M8.5, Head Dia.: 18MM
 Nissan Applications '86/
 Toyota & Mitsubishi
UNIT PACKAGE 25

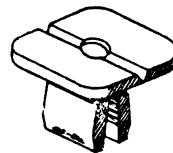

83-5690
 Replaces: 68425-H5000,
 9991-00-503,90662-671-0030
NUT
 Hole: M8sq., Screw: M4.2
 Nissan, Mazda, Honda & General Usage
UNIT PACKAGE 25



82-5534
 Replaces: 96706-P0105, & 90189-06010
NUT
 Hole: M8sq., Screw M4.2
 Nissan, Infinity, Lexus & Toyota
 General Purpose
UNIT PACKAGE 50

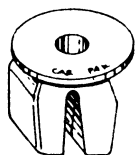

82-5571
 Replaces: 01281-00111, & 90189-06006
NUT-ANCHOR
 Hole: M10sq., Screw: M4.8
 Nissan, Infinity, Lexus & Toyota
UNIT PACKAGE 50



76-4295
 Replaces: 97606B0700, 75522-611-000
 & 9991-00-412
NUT-SIDE MARKER LAMP
 Hole: M6sq, Screw: M3.5
 Nissan, Honda, Mazda & General Usage
UNIT PACKAGE 100

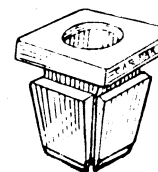

80-5236
 Replaces: 26023-H1000
NUT-HEADLAMP ADJUSTING
 Hole: M8sq., Screw: M4.8
 Nissan
UNIT PACKAGE 25

**82-5570**

Replaces: 01281-00072
& 90189-04014
NUT-ANCHOR
Hole: M7sq., Screw: M4.2
Nissan, Toyota, Lexus
UNIT PACKAGE 50

**82-5461**

Replaces: 96706-K1300,
90672-671-811 & MB106212
SCREW-ANCHOR
Hole: M7sq., Screw M4.2
Nissan 310, Honda, Mitsubishi
UNIT PACKAGE 25

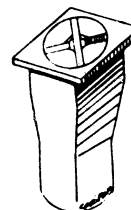
**81-5385**

Replaces: 96706-89901 & 9991-00-402
NUT-ANCHOR TYPE
Hole: M7sq., Screw: M4.2
Nissan, Mazda, Mitsubishi
UNIT PACKAGE 25

**98-7794**

Replaces: 01281-00081
GROMMET- SCREW
(Formerly 82-5573)
Hole: M8sq., Screw: M4
Nissan
UNIT PACKAGE 25

**83-5705**

Replaces: 90189-06005,
098-145, 01281-00023
CLIP-BODY MOULDING
M.6.3 Screw
Toyota, Mitsubishi, Nissan
UNIT PACKAGE 25

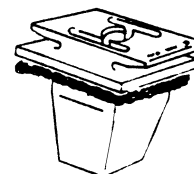
**95-7490**

Replaces: 01281-00481
NUT-GROMMET w/SEALER
White Plastic
M4.2 Screw, 8MM Sq. Hole
Nissan Pathfinder '86/
UNIT PACKAGE 10

**81-5420**

Replaces: 96706-H2500
NUT-ANCHOR TYPE
Plastic
Hole: M7sq., Screw: M4.2
Nissan
UNIT PACKAGE 25

**82-5575**

Replaces: 01241-00162
SCREW-GROMMET
Plastic
Hole: M9sq.
Nissan
UNIT PACKAGE 25

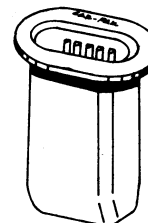
**83-5729**

Replaces: 90683-693-0000,
& 78856-R4301
SCREW-ANCHOR ADJUSTABLE
Hole: 8 x 15MM, Screw: M4.2
Nissan, Honda
UNIT PACKAGE 25

**82-5574**

Replaces: 01241-00161
SCREW-GROMMET
Plastic
Hole: M6, Screw: 3MM
Nissan
UNIT PACKAGE 25

**99-8040**

Replaces: 01281-00601
GROMMET-LICENSE PLATE, BUMPER
Trunk & Interior Trim
Plastic
Hole: M8.5 sq, Flange: 16MM,
PR: .8MM, Screw: M5
Nissan Cars & Trucks '86/
UNIT PACKAGE 25

**99-8339**

Replaces: 01281-00711
GROMMET - ROCKER MOULDING
Plastic - w/Seal
Hole: 10MM sq., Flange: 20MM,
O/L: 16.5MM, P.R.: 2MM,
Screw: M4.2 (#8)
Nissan & Infinity '95/
UNIT PACKAGE 10

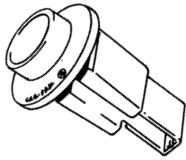

99-8462

Replaces: 01281-01081
GROMMET-FRONT BUMPER
 Plastic
 Hole: M10 sq., Flange: 16MM,
 Stand off 3.5x10MM,
 O/L: 22MM, P.R.: 2.5MM, Screw: M4.8 (#10)
 Nissan & Infinity '97/
 UNIT PACKAGE 15

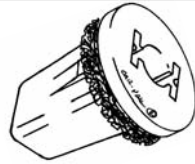

99-8492

Replaces: 01281-00331
GROMMET-BUMPER, ROCKER PNL.
 & LAMP MTG., Plastic w/Seal
 Hole: M10sq., Flange: 20 MM,
 O/L: 17MM, P.R.: 3MM, Screw: M6.3 (#14)
 Nissan 240SX, Altima, Maxima,
 Pathfinder & Quest '96/
 Infinity G35, Q45 & QX4 '97/
 UNIT PACKAGE 25



99-8493

Replaces: 01281-00831
GROMMET-BUMPER,
FENDER & LAMP MTG., Plastic
 Hole: M8.5sq., Flange: 16 MM,
 O/L: 11MM, P.R.: 1.5MM, Screw M4.2 (#8)
 Nissan 240SX, Altima, Frontier,
 Maxima, Pathfinder, Quest & Xterra '89/
 Infinity G20, I30/35 & QX4 '91/
 UNIT PACKAGE 25



99-8771

Not Supplied by O.E.
RETAINER-ROCKER MOULDING
 Plastic
 Hole:M11, Stem Lgth: 9MM,
 O/L: 15MM
 Nissan Murano 2003/
 UNIT PACKAGE 10

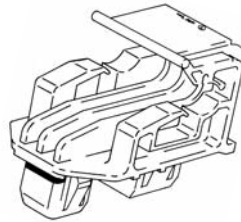

99-8686

Replaces: 26398-2Y001
RETAINER-HEADLAMP HOUSING
 Plastic
 Hole: 1-M9sq & 1-M10sq
 Nissan Sentra 2000-2006
 UNIT PACKAGE 5

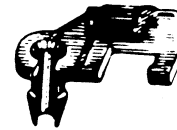

82-5568

Replaces: 82532-H8500
CLIP-ROD END
 Nissan
 UNIT PACKAGE 25

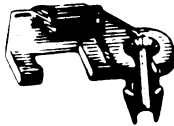

82-5567

Replaces: 80533-00100
CLIP-ROD END
 Nissan
 UNIT PACKAGE 25



82-5566

Replaces: 80532-00100
CLIP-ROD END
 Nissan
 UNIT PACKAGE 25



84-5838

Replaces: 65832-F5000
CLIP-HOOD INSULATION
 Plastic
 Nissan '81/
 UNIT PACKAGE 25



81-5425

Replaces: 85995-U0101
PLUG
 Silver Plastic
 Nissan
 UNIT PACKAGE 25

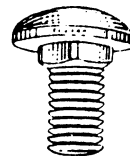

87-6207

Replaces: 01135-00511
BUMPER BOLT
 Black Chrome Finish
 M6-1.0 x 12.0MM
 Head: 14.0MM
 Imports, Nissan truck '82/
 UNIT PACKAGE 25

87-6208

Replaces: 01135-00201
BUMPER BOLT
 Bright Chrome Finish
 M6-1.0 x 12MM
 Head: 14.0MM
 Imports, Nissan truck '82/
 UNIT PACKAGE 25

**83-5723**

Replaces: 542290201P
**CLIP-WINDOW CRANK HANDLE
 RETAINING**
 Nissan
UNIT PACKAGE 50

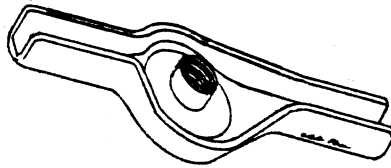
**83-5749**

Replaces: Nissan 165510-W7000
AIR CLEANER WING NUT
 M6 Dia.
 Nissan, Datsun Products
UNIT PACKAGE 25

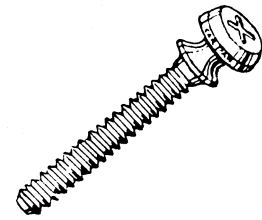
**80-5237**

Replaces: 26022-H1010
SCREW-HEADLAMP ADJUSTING
 Nissan, Toyota
UNIT PACKAGE 25

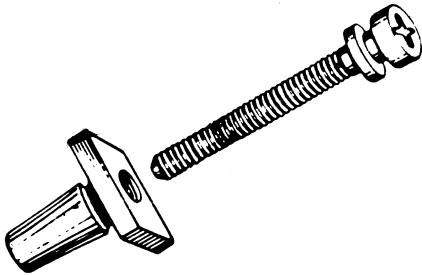
**71-3505**

Not Supplied By O.E.
NUT & SCREW-HEADLAMP ADJUSTING
 Nissan, Toyota '69 - '72
UNIT PACKAGE 25

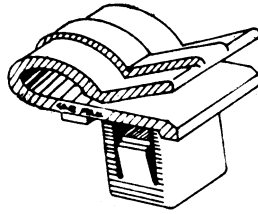
**81-5421**

Replaces: 62416-N8200
CLIP-WIRING
 Nissan
UNIT PACKAGE 25

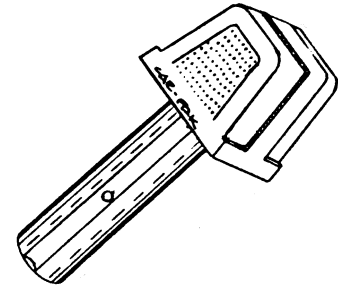
**82-5474**

Replaces: 80595-H5000
DOOR LOCK KNOB
 Nissan
UNIT PACKAGE 25

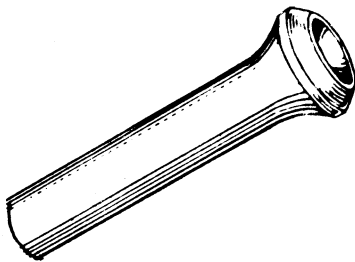
**82-5475**

Replaces: 80595-21003
DOOR LOCK KNOB
 Nissan
UNIT PACKAGE 25

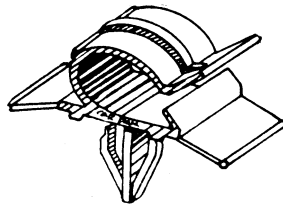
**81-5423**

Replaces: 24220-H5009
CLIP-WIRING
 Nissan
UNIT PACKAGE 25

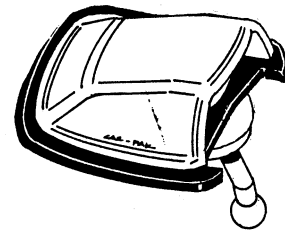
**84-5760**

Replaces: 78840-U8700
KNOB LATCH ASSEMBLY w/GASKET
FUEL TANK FILLER LID
 Nissan Pick-up Truck '80/
 210 '79/, 510 Station Wagon '79/
UNIT PACKAGE 10

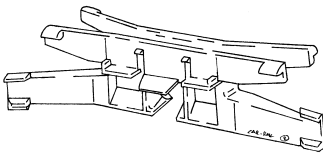
SUBARU**99-8071**

Replaces: 91017FA010
CLIP-WINDSHIELD MOULDING
 Plastic
 Subaru Forrester, '98/ Impreza '93-'98
UNIT PACKAGE 10

**98-7766**

Replaces: 01553-09241, 57728AC090
RETAINER - BUMPER, MUD GUARD
 Plastic
 Hole: M10, Stem Lgth: 18MM,
 Flange: 18MM
 Nissan Maxima & 240SX '94/
 & Subaru '95/
UNIT PACKAGE 10

**88-6387**

Replaces: 57754 G-A191
CLIP-BUMPER FASCIA
 Front & Rear
 Plastic
 Subaru '85-'86
UNIT PACKAGE 25

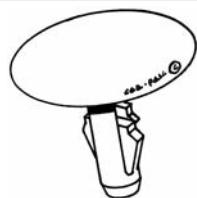
**99-8790**

Replaces: 90814FC001
RETAINER-HOOD INSULATOR
 Plastic
 Hole: M7, Head: 30MM,
 Stem Lgth: 13MM, P.R.: 3-5MM
 Subaru '98/
UNIT PACKAGE 10

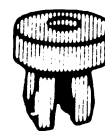
**99-8484**

Replaces: MS-480003
GROMMET NUT-GENERAL PURPOSE
 Formerly 81-5375
 Chrysler Arrow, Colt
 Other Japanese Models
UNIT PACKAGE 25

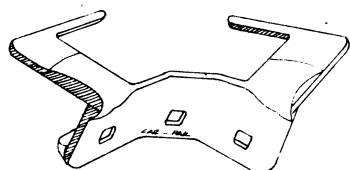
TOYOTA**83-5651**

Replaces: 75546-14080
CLIP-WINDSHIELD MOULDING
 Toyota Celica '81 - '87
UNIT PACKAGE 25

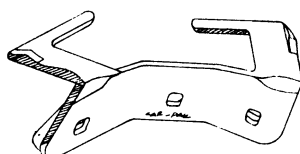
**83-5652**

Replaces: 75545-14081
CLIP-WINDSHIELD MOULDING
 Toyota Celica-Supra '82/
UNIT PACKAGE 25

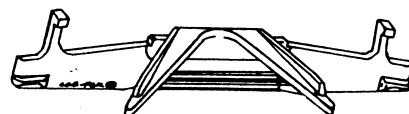
**87-6242**

Replaces: 75545-20060
CLIP-WINDSHIELD MOULDING
 Green Plastic
 Toyota Celica '86/
UNIT PACKAGE 25

**87-6241**

Replaces: 75546-20060
CLIP-WINDSHIELD MOULDING
 Blue Plastic
 Toyota Celica (FWD) '86/
UNIT PACKAGE 25

**87-6337**

Replaces: 75545-14060
CLIP-WINDSHIELD MOULDING
 Plastic
 Toyota Celica (RWD) '82-'85
UNIT PACKAGE 25

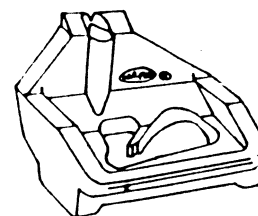
**85-5963**

Replaces: 75791-14030
CLIP-QUARTER WINDOW REVEAL MOULDING
 Toyota Celica & Supra '82/
UNIT PACKAGE 25

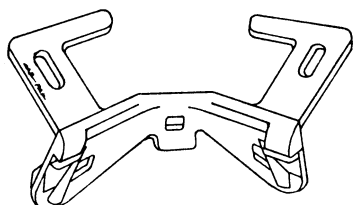
**83-5743**

Replaces: 75546-22030
CLIP-WINDOW MOULDING
 Toyota Cressida '81 - '82
UNIT PACKAGE 25

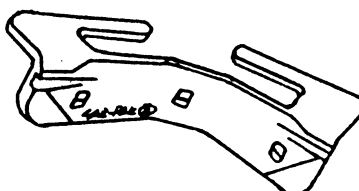
**86-6068**

Replaces: 75546-22050
CLIP-WINDOW MOULDING
 Plastic
 Toyota Cressida '85/
UNIT PACKAGE 25

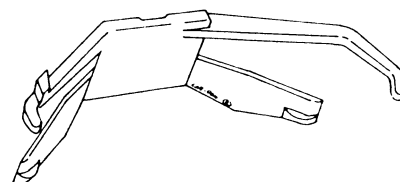
**91-7000**

Replaces: 75961-22030
CLIP-WINDSHIELD MOULDING
 Top Corner R.H.
 Plastic
 Toyota Cressida '88/
UNIT PACKAGE 10

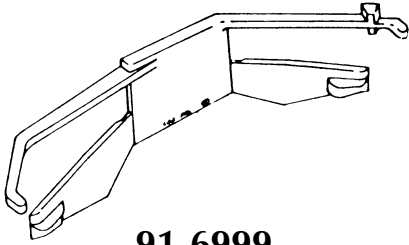
**91-6999**

Replaces: 75962-22040
CLIP-WINDSHIELD MOULDING
 Top Corner L.H.
 Plastic
 Toyota Cressida '88/
UNIT PACKAGE 10

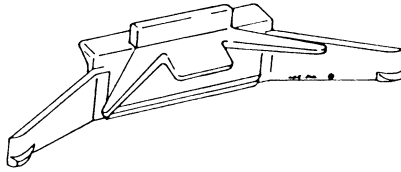
**91-6998**

Replaces: 75546-22060
CLIP-WINDSHIELD MOULDING SIDES
 Plastic
 Toyota Cressida '88/
UNIT PACKAGE 15

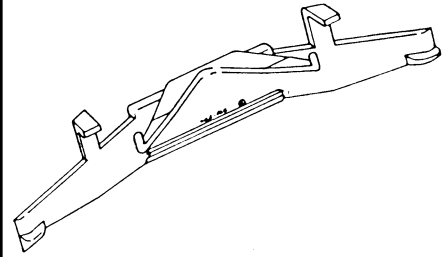
**91-6997**

Replaces: 75545-22070
CLIP-WINDSHIELD TOP
 Plastic
 Toyota Cressida '88/
UNIT PACKAGE 15

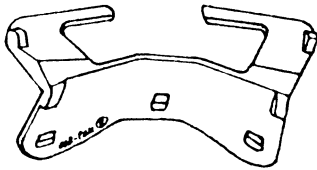
**85-5993**

Replaces: 75546-12020
CLIP-WINDSHIELD MOULDING
 Plastic
 Toyota Corolla '84-'88
UNIT PACKAGE 25

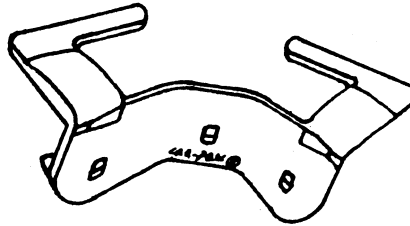
**86-6037**

Replaces: 75545-12040
CLIP-WINDSHIELD MOULDING
 Plastic
 Toyota Corolla '84-'88
UNIT PACKAGE 25

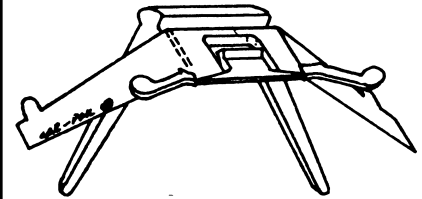
**87-6195**

Replaces: 75545-12050
CLIP-WINDSHIELD MOULDING
 White Plastic
 Toyota Corolla (RWD) '84/
UNIT PACKAGE 10

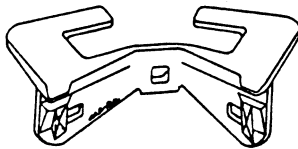
**83-5744**

Replaces: 75545-16020
CLIP-WINDSHIELD MOULDING
 Toyota Corolla Tercel '83
UNIT PACKAGE 25

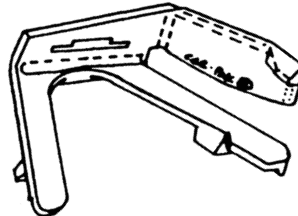
**87-6244**

Replaces: 75547-16030
CLIP-WINDSHIELD MOULDING
 Right - Yellow Plastic
 Toyota Tercel '83-'88
UNIT PACKAGE 10

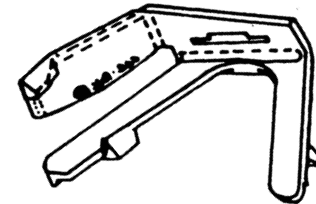
**87-6245**

Replaces: 75546-16030
CLIP-WINDSHIELD MOULDING
 Left - White Plastic
 Toyota Tercel '83-'88
UNIT PACKAGE 10

**87-6243**

Replaces: 75548-16030
CLIP-WINDSHIELD MOULDING
 White Plastic w/ Self Adhesive
 Toyota Cars & Trucks '83-'95
UNIT PACKAGE 25

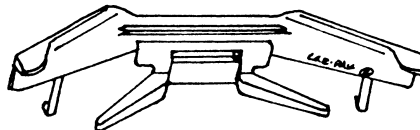
**88-6382**

Replaces: 75545-32020
CLIP-WINDSHIELD MOULDING
 Light Blue Plastic
 Toyota Tercel '87-'91
UNIT PACKAGE 25

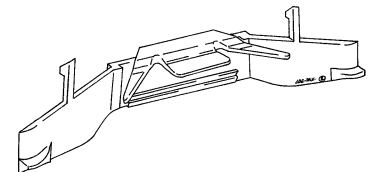
**97-7711**

Replaces: 75546-12060
CLIP-WINDSHIELD SIDE MOULDING
 Plastic-White
 Toyota Corolla Sedan & Wagon '88/'92
UNIT PACKAGE 15

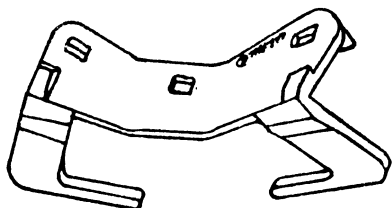
**86-6076**

Replaces: 75546-32010
CLIP-WINDSHIELD MOULDING
 Plastic
 Use w/84-5754
 Toyota Camry '86/
UNIT PACKAGE 25

**89-6615**

Replaces: 75547-32010
CLIP-BACK GLASS MOULDING
 Upper & Side
 Yellow Plastic
 Toyota Camry '87/
UNIT PACKAGE 15

**89-6616**

Replaces: 75397-32010
CLIP-BACK GLASS MOULDING LOWER
 White Plastic
 Toyota Camry '87-'91
UNIT PACKAGE 15

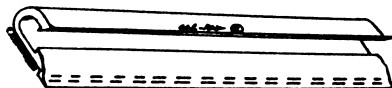
**87-6240**

Replaces: 75548-12060
CLIP-BACK GLASS MOULDING
 Upper & Side
 Yellow Plastic
 Toyota Camry '87-'91
UNIT PACKAGE 10

**93-7175**

Replaces: 75545-32030
CLIP-WINDSHIELD MOULDING
 White Plastic
 Toyota Camry '92/
UNIT PACKAGE 10

**81-5346**

Replaces: 75545-12031
CLIP-WINDSHIELD REVEAL MOULDING
 Toyota Corolla '80-'83
UNIT PACKAGE 50

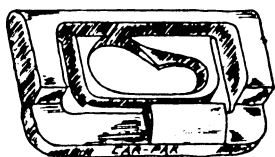
**81-5347**

Replaces: 75545-30021
CLIP-WINDSHIELD REVEAL MOULDING
 Toyota Cressida, Celica '78-'84
UNIT PACKAGE 50

**81-5348**

Replaces: 75546-22021B
CLIP-WINDSHIELD REVEAL MOULDING
 Toyota
UNIT PACKAGE 25

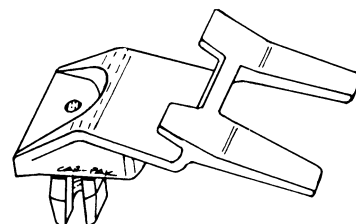
**83-5697**

Replaces: 75546-12050
CLIP-WINDSHIELD MOULDING
 Toyota
UNIT PACKAGE 25

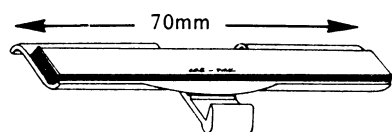
**84-5754**

Replaces: 75548-32010
CLIP-WINDSHIELD MOULDING
 Self Adhesive
 Use w/86-6076
 Toyota '82/
UNIT PACKAGE 25

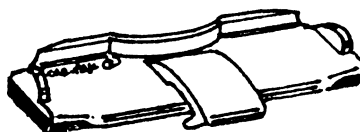
**86-6038**

Replaces: 75548-89102
CLIP-WINDSHIELD MOULDING
 Self Adhesive Plastic
 Toyota Truck '84/
UNIT PACKAGE 10

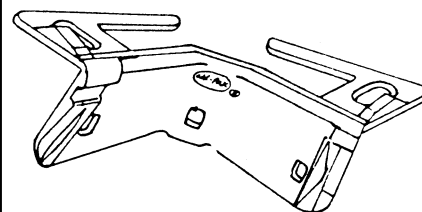
**85-5931**

Replaces: 75545-28010
CLIP-WINDSHIELD MOULDING
 Toyota Van '84
UNIT PACKAGE 25

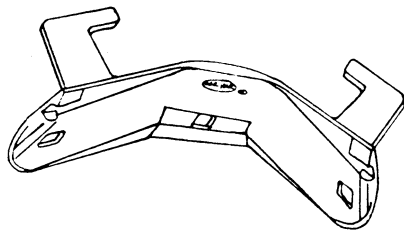
**85-5967**

Replaces: 75545-89101
CLIP-WINDSHIELD MOULDING
 Toyota Pick-Up Trucks '84/
UNIT PACKAGE 25

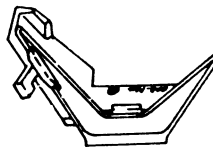
**90-6872**

Replaces: 75547-89105
CLIP-WINDSHIELD MOULDING
 CHROME
 Upper L.H. Corner
 Yellow Plastic
 Toyota Truck '88-'95
UNIT PACKAGE 10

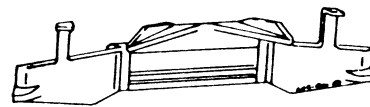
**90-6870**

Replaces: 75545-89103
CLIP-WINDSHIELD MOULDING
 CHROME
 Side L.H. & R.H.
 White Plastic w/o Center tab
 Toyota Truck '88-'95
UNIT PACKAGE 15

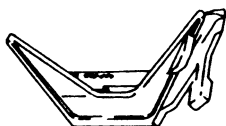
**90-6871**

Replaces: 75547-89104
CLIP-WINDSHIELD MOULDING
 CHROME
 Upper R.H. Corner
 White Plastic
 Toyota Truck '88-'95
UNIT PACKAGE 10

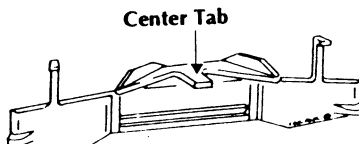
**90-6869**

Replaces: 75545-89102
CLIP-WINDSHIELD MOULDING
 CHROME
 Side L.H. & R.H.
 White Plastic w/Center Tab
 Toyota Truck '88/
UNIT PACKAGE 15

**90-6874**

Replaces: 75547-89107
CLIP-WINDSHIELD MOULDING CHROME
 Lower L.H. Corner
 Gray Plastic
 Toyota Truck '88-'95
UNIT PACKAGE 10

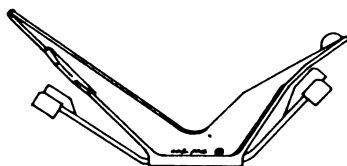
**90-6873**

Replaces: 75547-89106
CLIP-WINDSHIELD MOULDING
 CHROME
 Lower R.H. Corner
 Black Plastic
 Toyota Truck '88-'95
UNIT PACKAGE 10

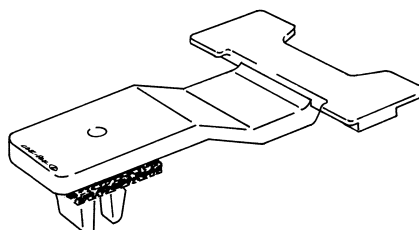
**99-8016**

Replaces: 75546-89102
CLIP-WINDSHIELD MOULDING, LOWER
 Black Plastic
 Toyota Pick-Up & 4 Runner '84 / '88
UNIT PACKAGE 10

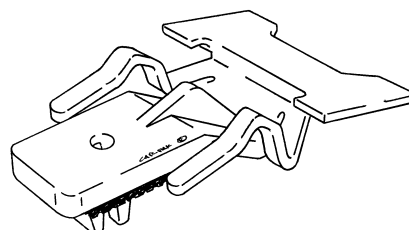
**99-8017**

Replaces: 75546-89101
CLIP-WINDSHIELD MOULDING, LOWER
 White Plastic
 Toyota Pick-Up & 4 Runner '84 / '88
UNIT PACKAGE 10

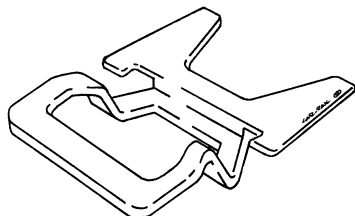
**99-8018**

Replaces: 75547-89101
CLIP-WINDSHIELD MOULDING, LOWER
 Plastic
 Toyota Pick-Up & 4 Runner '84 / '88
UNIT PACKAGE 10

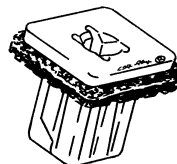
**98-7839**

Replaces: 90189-04150
GROMMET NUT
 WINDSHIELD MOULDINGS
 Plastic w/Seal
 Screw: M4.2, Hole: 7MM sq.
 Flange: 12MM sq.
 Toyota T100 '92/
UNIT PACKAGE 10

**2-PART****99-8338**

Replaces: 90467-10168
RETAINER - WINDSHIELD MOULDING & INTERIOR TRIM
 Plastic - 2 Piece, Black Pin, White Grommet
 Hole: M8.5, Upper Hd: 13MM,
 P.R.: 1.5MM, O/L: 20MM
 Trim Thk: 3.0MM
 Toyota Cars & Trucks '92/
UNIT PACKAGE 15

**99-8356**

Replaces: 88970345, 90467-10167
**RETAINER - WINDSHIELD GARNISH
 MOULDING**
 Plastic - Blue
 Hole: M8.5, Upper Hd: 13MM,
 O/L: 17.5MM,
 Trim Thk: 2.5MM
 Pontiac Vibe 2003 & Toyota/Lexus 2000/
UNIT PACKAGE 25

**99-8376**

Replaces: 62217-13010, 90467-10192
**RETAINER - WINDSHIELD OUTER
 GARNISH MOULDING**
 Plastic - White
 Hole: M8.5, Upper Hd: 13MM, O/L: 17MM,
 Trim Thk: 2.7MM, P.R.: 1.8MM
 Toyota Corolla, Matrix & Echo 2003/
 Lexus 2002/
UNIT PACKAGE 25

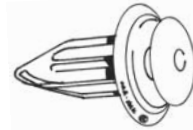
**99-8574**

Replaces: 90467-10188, 91560-S6A-003
**RETAINER-COWL, W/S GARNISH,
 INTERIOR TRIM, Plastic w/Seal**
 Hole: M8.5, Upper head: 13MM,
 Trim Thk: 2.5MM, O/L: 20MM,
 P.R.: 0.7-1.4MM
 Toyota Cars & Trucks '98-2004
 Acura 2005/ & Honda 2004/
UNIT PACKAGE 25

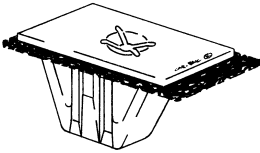
**99-8078**

Replaces: 90189-04184
GROMMET-COWL GRILLE
 Hole: 6X16MM, Flange: 12X21MM,
 Screw: M3.5(#6)
 Plastic
 Toyota Rav4, 4 Runner 8 Tacoma '95/
UNIT PACKAGE 25

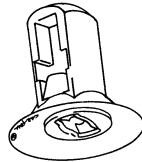
**98-7769**

Replaces: 90467-05051
NUT-COWL SIDE TRIM STUD
 Plastic
 Fits M5 Stud, 10MM Hex
 Toyota Trucks T100, 4 Runner '89/
UNIT PACKAGE 10

**99-8763**

Replaces: 75547-51021
**BLIND RIVET-WINDSHIELD & DRIP
 MOULDINGS w/Plastic Seal**
**Rivet-M3.2(1/8"), Flange: 6.4MM(1/4"),
 Rivet Lgth: 9.5MM (3/8")**
**Seal-Hole: M4(5/32"), Length: 12MM,
 Shoulder: 1.5x6.8MM, Flange: 10.4MM**
 Aluminum Rivet/Steel Mandrel
 Toyota Land Cruiser 2007/
 Lexus IS250/350 2006/
UNIT PACKAGE 15

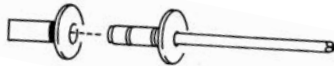
**99-8610**

Replaces: 90269-04051, 90269-A0006
**BLIND RIVET-WINDOW DOOR
 MOLDING**
 Hole: M4 (5/32"), Rivet: M3.2 (1/8"),
 Flange: 6MM (15/64"),
 G.R.: 1.2-3.4MM (0.047-0.134),
 Rivet Lgth: 7.1MM (9/32")
 Aluminum Rivet w/ Steel Mandrel
 & Plastic Seal
 Lexus ES, IS Models '98/Toyota Camry 2007
UNIT PACKAGE 15

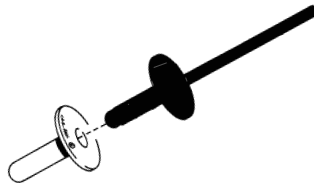
**99-8207**

Replaces: 90269-04053
BLIND RIVET - MOULDINGS
 Hole: M4, Rivet: M3.2, Flange: 8MM,
 G.R.: 1-4.75MM
 Black Aluminum Rivet w/Steel Mandrel
 and Plastic Seal
 Toyota Landcruiser & Lexus LX470 '98/
UNIT PACKAGE 10

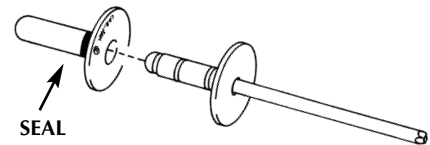
**99-8008**

Replaces: 90269-05054
**BLIND RIVET-GAS FILLER DOOR
 W/S SIDE MOULDINGS**
 Rivet: M5, Flange: 14MM, G.R.: 3-8MM
 Aluminum Rivet w/Steel Mandrel
 w/Plastic Seal
 Toyota Camry '97/
UNIT PACKAGE 10

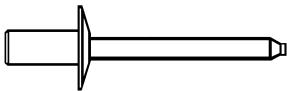
**99-8136**

Replaces: 90084-26002
**RIVET-FRONT & REAR DOOR WINDOW
 MOULDING**
 Closed End Sealing Type
 Aluminum Rivet w/Aluminum Mandrel
 M4 Rivet, Flange: 7.9MM,
 Grip Range: 1.6-6.3MM
 Toyota Camry '97/
UNIT PACKAGE 50

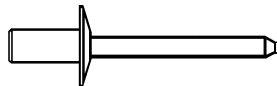
**97-7676**

Replaces: 90084-26001
RIVET- CLOSED END SEALING TYPE
 Aluminum Rivet, Aluminum Mandrel
 M5 Rivet, 9.5MM Flange
 3.2-6.3MM Grip Range
 Windshield Side Moulding
 Toyota Camry '97/
UNIT PACKAGE 50

**98-7856**

Replaces 90467-07117
RIVET-DRIVE TYPE (PUSH TO RELEASE)
 Cowl Grille
 Plastic
 Hole: M7, Flange: 17MM, P.R.: 3MM
 Lexus '97/, Toyota Camry '98 & Prius '01/
UNIT PACKAGE 10

**90-6806**

Replaces: 96057846, 09409-07308
MB475404, 90467-07076

RIVET-DRIVE TYPE (Removeable)
COWL, FRONT BUMPER
Plastic

Hole: M6, Washer: 15MM, P.R.: 2-5MM
Toyota Rav 4, G.M. Geo Tracker '89/
Chrysler & Mitsubishi '95/ Suzuki '89/
UNIT PACKAGE 10

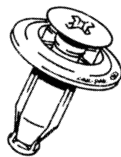
**99-7911**

Replaces: 90467-07146

RIVET- DRIVE TYPE, PHILLIPS HEAD
Cowl Grille & Trunk Trim
Plastic

Hole: M7, Flange: 16MM, P.R.: 3MM
Toyota Solara '99, Lexus & ES 300 '97/
UNIT PACKAGE 10

**99-8279**

Replaces: 90467-07192
RIVET - DRIVE TYPE (RE-USEABLE)
Cowl Vent

Plastic
Hole: M7, Flange: 15MM,
Stem Length: 9MM, P.R.: 2-5MM
Toyota RAV4 2002
UNIT PACKAGE 15

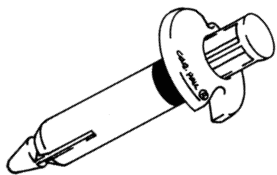
**99-8280**

Replaces: 90467-07193
RIVET - DRIVE TYPE (RE-USEABLE)
Cowl Vent
Plastic

Hole: M7, Flange: 15MM,
Stem Length: 20MM, P.R.: 12-15MM
Toyota RAV4 2002
UNIT PACKAGE 15

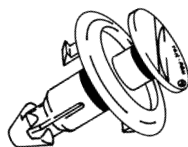
**99-8281**

Replaces: 90467-07195
RIVET - DRIVE TYPE (RE-USABLE)
Cowl Vent
Plastic

Hole: M7, Flange: 20MM,
Stem Lgth.: 8.5MM, P.R.: 5MM
Toyota Rav4 2002
UNIT PACKAGE 15

**95-7463**

Replaces: 90657-SA6-003, 90467-07072,
N304-13-356-B

RIVET-SCREW TYPE, COWL GRILLE
Hole: M7, Washer Head: 14MM
Length: 11MM

Honda Accord '90 - '91, Mazda & Toyota
UNIT PACKAGE 25

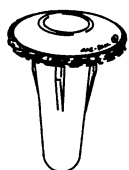
**98-7791**

Replaces: 90467-10152
GROMMET-COWL VENT
Plastic Use with 98-7792 or 99-8099
Hole: M9, Flange: 18MM

Stem Length: 16MM
Lexus '95/ & Toyota
UNIT PACKAGE 10

**99-8099**

Replaces: 90467-06093
RETAINER-COWL VENT
Plastic - Use with 98-7791
Head: 20MM, Stem Length: 18MM
Lexus LS400, GS300, SC300/400 '95/ &

Toyota
UNIT PACKAGE 10

**99-8148**

Replaces: 90467-08184
GROMMET - COWL VENT
Plastic - use w/99-8149
Hole: M8, Flange: 15MM

Toyota 4 Runner, Tacoma,
Pre-Runner & Tundra '95/
UNIT PACKAGE 15

**99-8149**

Replaces: 90467-07045-22
PIN RETAINER - COWL VENT
Plastic - use w/99-8148

Head: 13MM (textured),
Stem Length: 15MM
Toyota 4 Runner, Tacoma, Pre-Runner,
Tundra '95/
UNIT PACKAGE 15

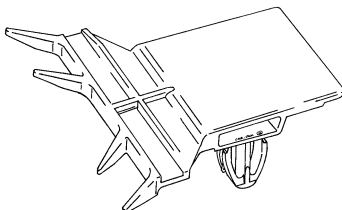
**99-7930**

Replaces: 75395-28010
CLIP-COWL VENT
Plastic

Hole: M10 Sq.
Toyota Previa '91-'97
UNIT PACKAGE 5

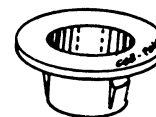
**87-6270**

Replaces: 90386-06008
CLIP-BODY SIDE MOULDING
Plastic

1/4 I.D., 5/16 Hole Clip
Toyota Celica & Supra '82-'86, Lexus
UNIT PACKAGE 25

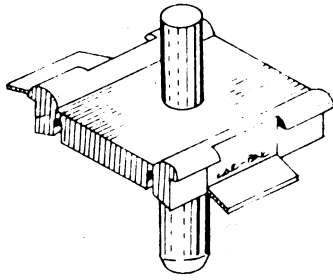
**82-5580**

Replaces: 75518-91503
CLIP-MOULDING
 Toyota
UNIT PACKAGE 25

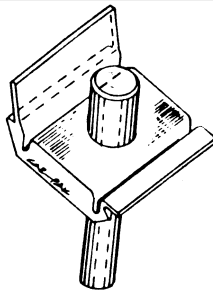
**82-5578**

Replaces: 75662-91256
CLIP-MOULDING
 Toyota
UNIT PACKAGE 25

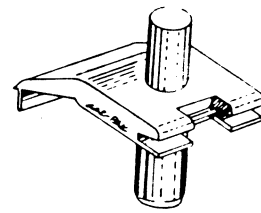
**82-5579**

Replaces: 75756-21010
CLIP-MOULDING
 Toyota
UNIT PACKAGE 25

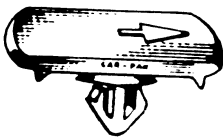
**76-4332**

Replaces: 75395-14020A
CLIP-MOULDING
 Toyota
UNIT PACKAGE 100

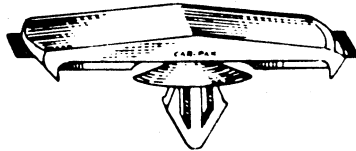
**76-4336**

Replaces: 75395-14010C
CLIP-MOULDING
 Toyota
UNIT PACKAGE 100

**81-5350**

Replaces: 75791-14010C
CLIP-DRIP MOULDING
 Toyota
UNIT PACKAGE 50

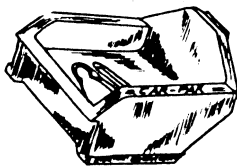
**81-5351**

Replaces: 75791-20010
CLIP-BELT MOULDING
 Toyota
UNIT PACKAGE 25

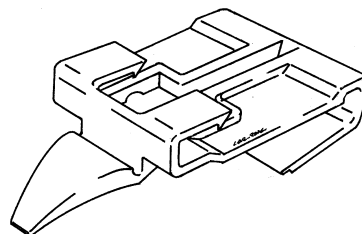
**98-7825**

Replaces: 68211-32040
CLIP- BELT & DOOR GLASS MOULDING
 Plastic
 Toyota Camry '91-'96
UNIT PACKAGE 15

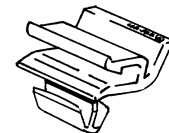
**99-8145**

Replaces: 75791-33020
CLIP - BELT MOULDING, FRONT & REAR
 Plastic
 Fits a 3.4MM wide slot
 Toyota Camry '97-2000
UNIT PACKAGE 15

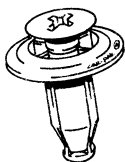
**99-8022**

Replaces: 90467-06133, 94858343
RIVET-DRIVE TYPE w/PHILLIPS RECESS
 Rocker Panel
 Textured: Plastic-Paint to match
 Hole: M6, Flange: 14MM, PR: 4MM
 Toyota '98/ & Pontiac Vibe 2003/
UNIT PACKAGE 15

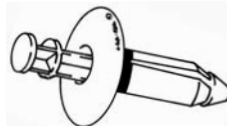
**99-8680**

Replaces: 90467-08180
**RIVET- DRIVE TYPE, BUMPER
 & ROCKER PANEL**
 Plastic, Textured
 Hole: M8, Flange: 17MM,
 Stem Lgth: 12MM, P.R.: 7MM
 Toyota Camry 2007
 Lexus RX335/350/400h 2004/
UNIT PACKAGE 15

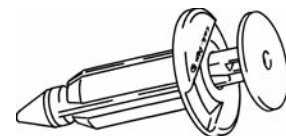
**99-8794**

Replaces: 75867-30120
RETAINER-ROCKER MOULDING
 Plastic
 Hole: M8.5, Flange: 18MM,
 Stem Lgth: 12MM, Head: 15MM,
 P.R.: 5.5-7.0MM
 Toyota Camry & Avalon 2005/
 Lexus ES, GS, IS & LS 2006/
UNIT PACKAGE 15

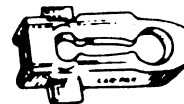
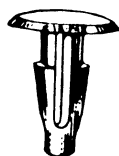
**99-7988**Replaces: 90467-11063,
88970493, 77553-65D00**RETAINER-ROCKER PANEL MOULDING**
PlasticHole: M9
Toyota '90/, Pontiac Vibe 2003/
Suzuki Gr. Vitera ''-2004
UNIT PACKAGE 15**99-8776**Replaces: 90189-04059
GROMMET-ROCKER MLD,
PILLARS & FLOOR, PlasticHole: 6x14.5MM, Flange: 12x18MM,
Leg Lgth: 7.5MM Screw: M3.5(#6)
Lexus ES, IS, RX & SC '92/
Toyota Avalon, Corolla, FJ & Matrix 2000/
Scion 2004-2006
UNIT PACKAGE 25**82-5581**Replaces: 75419-21010
CLIP-MOULDING
Toyota
UNIT PACKAGE 25**76-4333**Replaces: 90467-07050
01553-00172**CLIP-WEATHERSTRIP**
& TRIM PANEL
Toyota, Datsun
UNIT PACKAGE 100**89-6672**

Replaces: 90687-SA5-003, 90467-08008

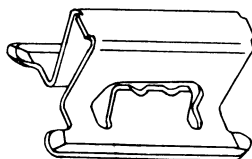
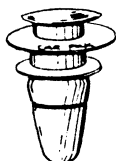
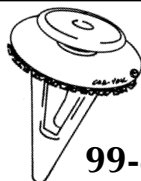
CLIP-COWL TOP, WEATHERSTRIP,
TRIM PANELS
Black PlasticHole: M5, Head: 13MM,
Stem Lgth: 15MM, P.R.: 4MM
Honda Accord '87/ & Acura Vigor '92-'94,
Toyota
UNIT PACKAGE 25**86-6063**Replaces: 67868-89101, G031-58-762
CLIP-WEATHERSTRIP
Plastic
Toyota Car & Truck '83/ & Mazda '86/
UNIT PACKAGE 50**87-6226**Replaces: 90468-04030
RETAINER-BUMPER STRIP
Toyota '84/Various Models
UNIT PACKAGE 50**84-5802**Replaces: 90183-03001
CLIP-FRONT BUMPER CUSHION
Toyota '82/
UNIT PACKAGE 50**91-6917**Replaces: 90467-09093
RIVET-SCREW TYPE
Plastic
Hole Size M9
Flange 15mm: G.R. 3-7mm
Front & Rear Bumper Covers
Lexus LS-400 '90/, Toyota '93/
UNIT PACKAGE 10**81-5389**Replaces: 67771-22020
CLIP- TRIM PANEL
Honda, Toyota
UNIT PACKAGE 25**99-8282**Replaces: 67771-12070
RETAINER - DOOR PANEL &
ROCKER MOULDING
Plastic w/SealHole: M9, Upper Hd: 13MM,
P.R.: 1.5MM, O/L: 19.7MM,
Trim Thk.: 2.5MM
Toyota Avalon, Corolla '93/ &
Lexus SC300/400 '92-2000
UNIT PACKAGE 15**99-8359**Replaces: 67771-12080
RETAINER - DOOR PANEL & ROCKER
MOULDINGPlastic - 2 Piece, Yellow Pin,
White Grommet
Hole: M8, Upper Hd: 13MM, P.R.: 1MM,
O/L: 20MM, Trim Thk: 3MM
Toyota & Lexus '98/
*UNIT PACKAGE 15***2-PART**

**90-6807**

Replaces: 96057847
09409-07313, 90467-07313

RIVET-DRIVE TYPE
RADIATOR GRILLE RETAINER,
DOOR PANEL, Plastic

Hole: M7, Washer: 11MM, P.R.: 7-10MM
Toyota 4 Runner & Camry
G.M. Geo Tracker '89/
Suzuki Sidekick '89/
UNIT PACKAGE 10

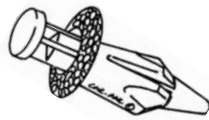
**99-8796**

Replaces: 90467-07071-22
RIVET-DRIVE TYPE (Re-Useable)
FRONT BUMPER, Plastic-Textured
Hole: M7, Flange: 11MM,
Stem Lgth: 9.5MM, P.R.: 4-6MM
Toyota Matrix & Yaris 2003/
UNIT PACKAGE 25

**99-8587**

Replaces: 90467-07201
RIVET-DRIVE TYPE, Engine Under Cover
Plastic
Hole: M7, Flange: 20MM,
Stem Lgth: 10MM, P.R.: 2.2-6.5MM
Toyota Avalon, Camry, Solara 2002/
& Lexus ES300/330 2002/
UNIT PACKAGE 10

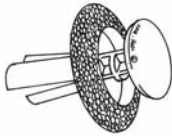
**99-8764**

Replaces: 90467-07211
DRIVE RIVET-BUMPER,
RADIATOR COVER, GRILLE
Plastic-Textured
Hole: M7, Flange: 19MM,
Stem Lgth: 8MM & 10MM, P.R.: 6MM
Toyota Avalon, Camry, Highlander 2005/
Scion xB 2008, Lexus IS & LS 2007/
UNIT PACKAGE 10

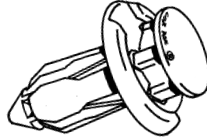
**99-8275**

Replaces: 01553-09611,
01553-10501, 90467-08185
RETAINER - DRIVE TYPE
Grille, Bumpers, Trunk Trim, Plastic
Hole: M8, Flange: 18MM
Stem Length: 10MM, P.R.: 6.3MM
Nissan Maxima, Sentra '94/
Infiniti G20, I35, Q45 '99/
Lexus & Toyota '97/, Scion 2004/
UNIT PACKAGE 15

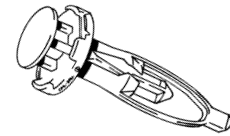
**96-7606**

Replaces: 52161-16010
RETAINER- FRONT-BUMPER
Plastic-Black
Hole Dia: M9, Flange Dia: 18MM
Stem Lgth: 28MM
Toyota Tercel '95/, Lexus '97/, Geo Prism
& Pontiac Vibe 2003/
UNIT PACKAGE 5

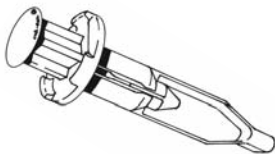
**99-8576**

Replaces: 52161-20010
RIVET-DRIVE TYPE
BUMPER COVERS & GRILLE
Plastic
Hole: M9, Flange: 18MM,
Stem Lgth: 31MM, P.R.: 3.5-10MM
Toyota & Scion 2000/
UNIT PACKAGE 15

**98-7770**

Replaces: 90467-09139
01553-03803
RIVET-DRIVE TYPE, FRONT BUMPER
Plastic
Hole: M9, Washer Dia: 18MM
Stem Length: 12MM
Lexus & GS300 '93-'97
Toyota '93/, Nissan
UNIT PACKAGE 10

**99-8798**

Replaces: 90467-05090-B1
RIVET-SCREW TYPE, REAR BUMPER
Plastic
Hole: M5, Flange: 10MM,
Stem Lgth: 12MM, P.R.: 4-7.5MM
Toyota Matrix & Scion 2008/
UNIT PACKAGE 10

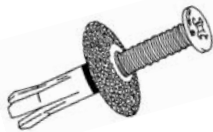
**97-7704**

Replaces: MB888869, 90505-SLO-003,
90467-08155
RIVET-SCREW TYPE
Bumper Cover
Plastic
Hole: M8, Stem: 20.5MM,
Panel: 13MM, HD 20MM
Chrysler, Mitsubishi, Acura, Toyota '93/
UNIT PACKAGE 15

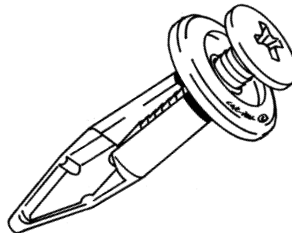
**98-7855**

Replaces: 90467-09127
RIVET-SCREW TYPE
Plastic-Front Bumper Cover
Hole: M9, Flange: 20MM, P.R.: 6MM
Lexus ES 300 '97/, Toyota '97
UNIT PACKAGE 10

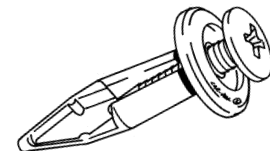
**98-7847**

Replaces- 94853733, 90467-09101
RIVET-SCREW TYPE, FRONT BUMPER
Plastic
Hole: M9, Flange: 18MM,
Stem Lgth.: 25MM, P.R.: 6MM
Pontiac Vibe 2003/, Geo Prism '93-'97,
Lexus ES300 '93/,
Toyota 4Runner, Corolla,Rav4 & Tundra '93/
UNIT PACKAGE 25

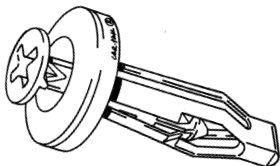
**98-7790**

Replaces: 90467-09143
RIVET-DRIVE TYPE (Twist to Release)
 Rear Bumper Cover, Plastic
 Hole: M9, Flange: 19MM, P.R.: 5.5MM
 Lexus '90/
 Toyota Supra '93-'98
UNIT PACKAGE 10

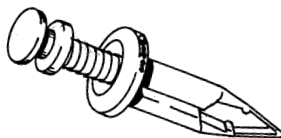
**96-7603**

Replaces: 90467-09096
RIVET- SCREW TYPE
 Front & Rear Bumper
 Plastic
 Hole Dia: M9, Stem Lgth: 26.5MM
 Washer Dia: 15MM
 Lexus, LS400, SC300, SC400 '95/
 Toyota Supra '93-'98
UNIT PACKAGE 10

**99-8575**

Replaces: 90467-A0008
RETAINER-BUMPER COVERS
 Plastic
 Hole: M6.35, Head: 19MM,
 Stem Lgth: 16MM, P.R.: 2.7-7.3MM
 Toyota, Lexus & Scion '95/
UNIT PACKAGE 50

**99-8677**

Replaces: 52535-50060, 52535-0E010
GROMMET-FRONT BUMPER
 Plastic
 Hole: 9x12MM, Screw: M5.48 or M6.0
 Toyota Camry, Highlander
 & Tacoma 2001/
 Lexus RX330/350/400h,
 LS430 & IS250/350 2001/
UNIT PACKAGE 5

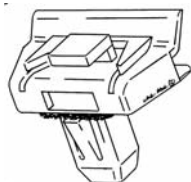
**99-8801**

Replaces: 52197-52010
RETAINER-FRONT BUMPER
 Plastic, Black w/Seal
 Hole: M9, StemLgth: 12.5MM,
 O/L: 16.6MM, Top Fold: 15x30MM
 Toyota Highlander 2000-2007
UNIT PACKAGE 5

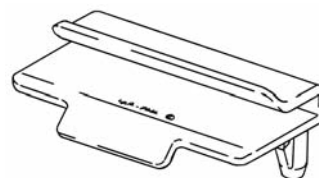
**99-8800**

Replaces: 52115-48040
RETAINER-FRONT BUMPER
 Plastic, Grey
 Hole: (2)M6, Stem Lgth: 8MM,
 O/L: 16.6MM, Top Fold: 11x48MM
 Toyota Highlander 2001-2007
UNIT PACKAGE 10

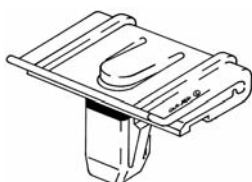
**99-8746**

Replaces: 90084-46020
RETAINER-BUMPER COVER
 Plastic
 Hole: M9sq., Top: 23x30MM,
 Stem Lgth: 12MM
 Toyota Avalon, Camry & Solara 2002/
UNIT PACKAGE 10

**99-8758**

Replaces: 90189-05142
GROMMET-HEADLAMP MOUNTING
 Plastic
 Hole: M9sq., Flange: 17MM,
 Stem Lgth: 8MM, P.R.: 3MM, Screw:
 M4.2(#8), Sec. Hole: M8
 Toyota Cars & Trucks 2001/
 Scion xB 2004-2006
UNIT PACKAGE 25

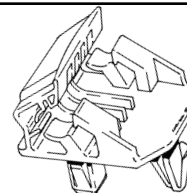
**99-8529**

Replaces: 53271-44010
RETAINER-HEADLAMP HOUSING MOUNTING
 Plastic
 Hole: 1-M9 & 1-M10 sq.
 Toyota Camry & RAV4 2001/
 Lexus IS300 2001/
UNIT PACKAGE 5

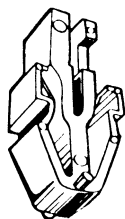
**82-5556**

Replaces: 90467-13008
CLIP-GRILLE
 Toyota
UNIT PACKAGE 25

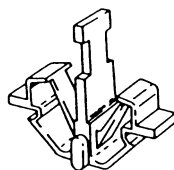
**90-6759**

Replaces: 90467-17004
CLIP-RADIATOR GRILLE
 Back Plastic
 Toyota Cressida '84-'87
UNIT PACKAGE 15

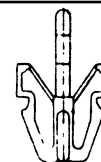
**88-6499**

Replaces: 90467-12020, H200-50-715
 BFH67-50715, 75103-SJ4-003
CLIP-GRILLE & HEADLAMP DOOR
 Gray Plastic
 Toyota Car & Truck '83/
 Chevrolet Nova '86/, Mazda 323 '86/
 Ford Festiva & Tracer '88/
 Honda Accord '90-'93, Ford Explorer '96/
UNIT PACKAGE 25

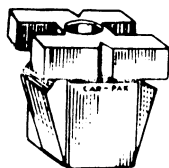
**76-4335**

Replaces: 90189-04008
MB-029-111
NUT- GRILLE
Toyota
UNIT PACKAGE 100

**99-8679**

Replaces: 75392-35200, 75392-04010
RETAINER-FENDER FLARE & BUMPER
Plastic - Blue
Toyota Camry, FJ,
Rav4 & Tacoma 2005/
UNIT PACKAGE 15

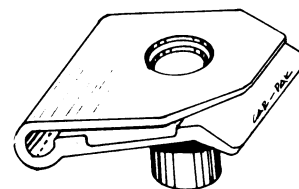
**83-5706**

CLIP-GENERAL USAGE
Black, M5 Hole
Nissan/Toyota
UNIT PACKAGE 25

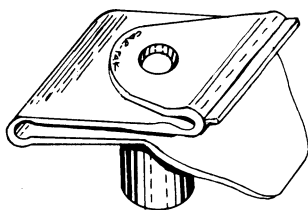
**83-5698**

Replaces: 53879-14010A
CLIP-INNER FENDER
M5 Hole
Toyota & Lexus '92/
UNIT PACKAGE 25

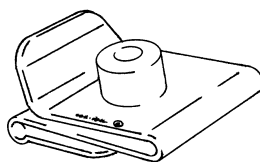
**99-8102**

Replaces: 90467-04023
CLIP-FENDER SPLASH SHIELD
Plastic (U-Nut Style)
Screw: M4.8 (#10) Fits Thick Panels
Toyota Camry 2000
UNIT PACKAGE 25

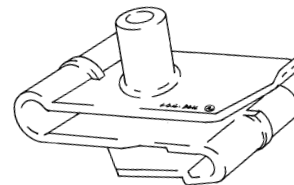
**99-8483**

Replaces: 88970766, 90467-05138
U-NUT-FENDER APRON & FRONT BUMPER
Plastic
Screw: M5.48 (#12)
Pontiac Vibe, Toyota Corolla,
Lexus GX470 2003/
UNIT PACKAGE 10

**99-8577**

Replaces: 90467-05114
U-NUT-BUMPER & FENDER APRON
Plastic
Screw: M5.48 (#12)
Toyota & Lexus 2000/
UNIT PACKAGE 10

99-8501

**99-8501**

Replaces: 47749-58010
PIN-FRONT FENDER
Plastic, Use w/99-8502
Head: 15.5MM, Stem Lgth: 25MM
Toyota Solara, Highlander,
Sienna & 4Runner 2000/
Lexus GX470 2003/ & Pontiac Vibe 2009
UNIT PACKAGE 10

99-8502

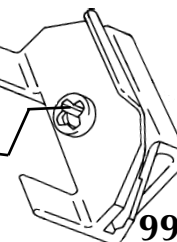
**99-8502**

Replaces: 53879-58010, 19183888
CLIP-FRONT FENDER, FRONT BUMPER
Plastic, Use w/99-8501
Toyota Solara, Highlander,
Sienna & 4Runner 2000/
Lexus GX470 2003/ & Pontiac Vibe 2009
UNIT PACKAGE 5

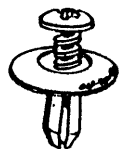
**97-7714**

Replaces: 90467-07044
RIVET-SCREW TYPE
Fender Splash Shield
Plastic
Hole: M7, Flange Dia: 20MM,
Grip Range: 3MM
Toyota Trucks '92/
UNIT PACKAGE 10

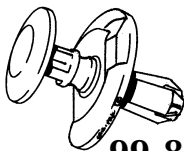
**99-8103**

Replaces: 90467-07164,
09409-07332, 30020637
RIVET-DRIVE TYPE
Grille, Bumper, Fender Apron/Flare-Plastic
Hole: M7, Flange: 20MM,
Stem Lgth: 10MM
Toyota Camry, MR2, Sienna & Echo '97/
Suzuki Gr. Vitera/Vitera, XL7, Ari '99/, G.M.
Tracker '99/
UNIT PACKAGE 10

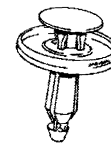
**97-7717**

Replaces: 90467-07166
RIVET-DRIVE TYPE
Front Fender Splash Shield
Plastic
Hole: M7, Flange Dia: 20MM,
Grip Range: 3MM
Toyota '94/, Lexus GS '98/, Scion 2004/
UNIT PACKAGE 15

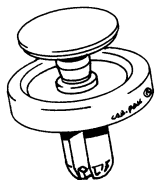
**99-8373**

Replaces: 88970767, 90467-10183
RIVET-DRIVE TYPE, FRONT FENDER LINER
 Plastic-Textured Head
 Hole: M7, Flange: 18MM,
 Stem Lgth: 7.5MM, P.R. 3MM
 Pontiac Vibe 2003,
 Toyota Celica, Corolla, Solara & Matrix '99/
UNIT PACKAGE 10

**99-8517**

Replaces: 53879-60010
RIVET- DRIVE TYPE, FENDER LINER
 Plastic, Textured Head
 Hole: M7, Flange: 18MM,
 Stem Lgth: 6.5MM, P.R.: 3.5MM
 Toyota Land Cruiser '98/
 Rav4 2001/ & Lexus LX470 '98/
UNIT PACKAGE 10

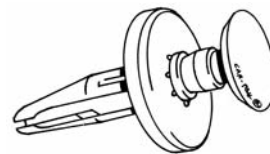
**99-8765**

Replaces: 53888-48010
DRIVE RIVET-WHEEL OPENING
 Plastic-Textured
 Hole: M7, Flange: 18MM,
 Stem Lgth: 14MM, P.R.: 4MM
 Toyota Highlander 2001/
UNIT PACKAGE 5

**97-7710**

Replaces: 90467-10107
CLIP-FENDER SPLASH SHIELD
 Plastic-Textured Head
 Hole: M8, Head Dia: 17MM,
 Stem Lgth: 11MM
 Toyota Truck '88-'98
UNIT PACKAGE 10

**99-8374**

Replaces: 90467-08023
RETAINER - FRONT FENDER LINER
 Plastic
 Hole: M7, Head: 12MM,
 O/L: 9MM, P.R.: 2MM
 Toyota Corolla & Matrix 2003
UNIT PACKAGE 25

**99-8355**

Replaces: 88969790, 75867-21010
RETAINER - FENDER FLARE
 Plastic
 Hole: M8.5, Hd: 10x13MM, O/L: 13.5MM,
 Trim Thk: 2.5MM
 Pontiac Vibe 2003 & Toyota Echo 2002/
UNIT PACKAGE 25

**99-8170**

Replaces: 90189-06114
GROMMET - FRONT FENDER LINER
 Plastic
 Hole: M9 Sq., Flange: 18MM,
 Screw: M5.48 (#12)
 Toyota Rav 4 '96/
UNIT PACKAGE 15

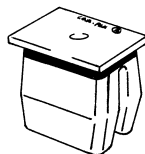
**99-8174**

Replaces: 90189-05105
GROMMET-FRONT FENDER FLARE
 Plastic
 Hole: 7 X 13MM, Flange: 10 X 15MM,
 Screw: M4.2(#8)
 Toyota Rav4 '96/
UNIT PACKAGE 15

**99-8173**

Replaces: 75498-42010
RETAINER-REAR FENDER FLARE
 Plastic
 Hole: 9 X 12MM, Flange: 20MM,
 Flare Hole: 7 X 9MM
 Toyota Rav4, T 100 Pick Up '93/
UNIT PACKAGE 10

**99-8327**

Replaces: 90904-67036
RETAINER - FENDER FLARE
 Plastic - Blue
 Hole: M9 sq., Flange: 17MM, O/L: 24MM
 Toyota Trucks 2001/
UNIT PACKAGE 15

**99-8328**

Replaces: 90904-67037
RETAINER - FENDER FLARE
 Plastic - Red
 Hole: M9 sq., Flange: 17MM, O/L: 20MM
 Toyota Trucks 2001/
UNIT PACKAGE 15

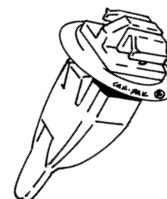
**99-8444**

Replaces: 90467-11100
RETAINER-FRONT FENDER FLARE
 Plastic-Yellow
 Hole: M9 sq., Flange: 17MM, O/L: 25MM
 Toyota Trucks '96/
UNIT PACKAGE 15

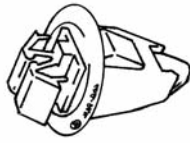
**99-8556**

Replaces: 75396-35020, 75495-35010

**RETAINER-FENDER FLARE &
SIDE MOULDING**

Plastic-Blue

Hole: M9sq., Flange: 17MM, O/L: 17MM
Toyota 4Runner, Tacoma 2003/ &
Lexus GX470 2003-2004
UNIT PACKAGE 15**99-8555**

Replaces: 75395-35070, 75397-35010

**RETAINER-FENDER FLARE &
SIDE MOULDING**

Plastic-Orange

Hole: M9sq., Flange: 17MM, O/L: 22.5MM
Toyota 4Runner, Tacoma 2003/ &
Lexus GX470 2003-2004
UNIT PACKAGE 15**99-8101**

Replaces: 90189-06157

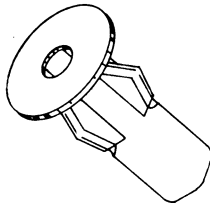
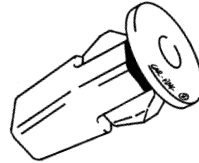
RETAINER-FENDER SPLASH SHIELD
PlasticHole: M8.5 SQ., Flange: 20MM, O/L:
24MM
Toyota Camry & Solara '98/
UNIT PACKAGE 15**83-5694**Replaces: 96706-W1000
90189-06013, 90189-06065**CLIP-FENDER SHIELD**Hole: M8.5 sq., Flange: 20MM,
O/L: 19MM, P.R.: 1-2.5MM
Toyota
UNIT PACKAGE 25**98-7840**

Replaces: 90189-06028, 94854203

RETAINER- WHEEL APRON
PlasticHole: M9 sq., Flange: 16MM, O/L: 20MM
P.R.: 2-3MM
Toyota Tacoma, T100 & 4Runner '95/
& Pontiac Vibe 2003/
UNIT PACKAGE 15**99-8100**

Replaces: 90189-06104

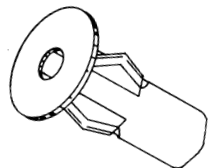
GROMMET-FENDER SPLASH SHIELDScrew: M5.48, Flange: 18MM,
Hole: 8.5MM Sq., O/L: 17MM, P.R.: 1.3MM
Plastic
Toyota Camry & Avalon '97/
UNIT PACKAGE 10**99-8218**

Replaces: 90189-06214

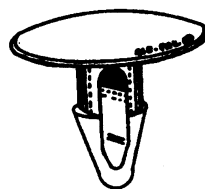
RETAINER - FENDER SPLASH SHIELD
PlasticHole: M9 Sq., Flange: 16MM,
O/L: 20MM, P.R.: 4MM
Toyota Sequoia, Tacoma &
Tundra Trucks 2000/
UNIT PACKAGE 10**98-7824**

Replaces: 90467-09006

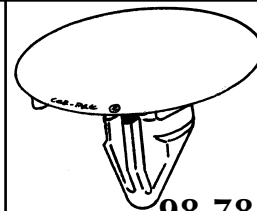
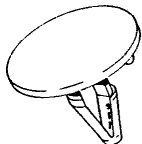
RETAINER- HOOD INSULATIONPlastic w/Textured Head
Hole: M7, Head: 30MM
P.R.: 4MMToyota & Lexus '88/
UNIT PACKAGE 15**98-7848**Replaces: 90467-09050, 90467-A0003,
88970747, 94858509**RETAINER-HOOD INSULATOR**
PlasticHole: M8, Head: 25MM, G.R.: 4MM
Toyota Camry, Lexus, Scion,
Pontiac Vibe 2003/
UNIT PACKAGE 15**97-7708**

Replaces: 90467-08124

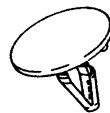
RETAINER-HOOD INSULATION
PlasticHole: M7, Head Dia: 25MM,
Stem Lgth: 12MM
Toyota Supra '93-'98
Lexus '89/
UNIT PACKAGE 15**97-7713**

Replaces: 90467-09004

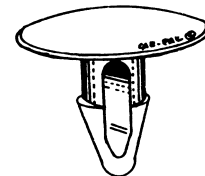
RETAINER-HOOD INSULATION
PlasticHole: M7, Head Dia: 30MM,
Stem Lgth: 16MM
Toyota Trucks '95/
UNIT PACKAGE 15**87-6236**

Replaces: 90467-09008

RETAINER-HOOD INSULATIONHole: M7, Head: 30MM, Stem Lgth.: 19MM
Plastic
Toyota Cressida & Supra '85-'88
UNIT PACKAGE 25

**99-8797**

Replaces: 90467-08136
RETAINER-HOOD INSULATION
 Plastic
 Hole: M7, Head: 20MM,
 Stem Lgth: 9MM
 Toyota Echo, Sienna, Yaris '98/
 Scion 2005-2006
UNIT PACKAGE 25

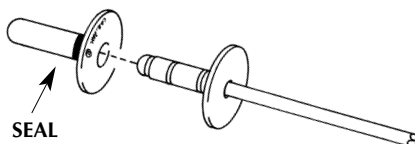
**99-8008**

Replaces: 90269-05054
BLIND RIVET-GAS FILLER DOOR
 W/S SIDE MOULDINGS
 Rivet: M5, Flange: 14MM, G.R.: 3-8MM
 Aluminum Rivet w/Steel Mandrel
 w/Plastic Seal
 Toyota Camry '97/
UNIT PACKAGE 10

**99-8209**

Replaces: 90269-06013
BLIND RIVET - GAS FILLER DOOR
 Hole: M6, Rivet: M4.8, Flange: 14MM,
 G.R.: 1.6-6.35MM
 Aluminum Rivet w/Steel Mandrel
 and Plastic Seal
 Toyota Camry '97/ & Lexus IS300 2001
UNIT PACKAGE 15

**81-5352**

Replaces: 77358-12021
CLIP-FUEL TANK FILLER LID
 Toyota
UNIT PACKAGE 25

**81-5386**

Replaces: 76906-T3000
 9047-11005
CLIP-TRIM PANELS
 Datsun, Toyota
UNIT PACKAGE 25

**82-5559**

Replaces: 90467-08004, 90467-08011,
 90080-46010, 90467-A0009
CLIP-PANEL
 Hood Seal
 Lexus & Toyota '84/
UNIT PACKAGE 50

**99-8397**

Replaces: 67868-02020, 67867-12150
RETAINER- FRONT & REAR
DOOR WEATHERSTRIP
 Plastic
 Hole: M6, Head: 5x15MM, O/L: 15MM
 Toyota Cars & Trucks '90/ & Lexus '99/
 Scion xB 2004/
UNIT PACKAGE 25

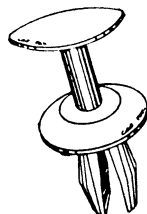
**82-5558**

Replaces: 10116-41810
RIVET-TRIM ATTACHING
 Toyota
UNIT PACKAGE 25

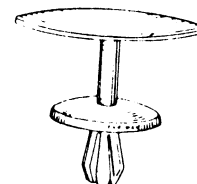
**82-5577**

Replaces: 90467-07005
RIVET-SEAT BACK
 Toyota, Isuzu
UNIT PACKAGE 25

**97-7716**

Replaces: 90467-07059-22
RIVET-DRIVE TYPE
 Door Trim & Trunk
 Plastic W/ Textured Head
 Hole: M7, Flange Dia: 15MM,
 Grip Range: 2MM
 Toyota, Celica, Camry & MR2 '90/
UNIT PACKAGE 10

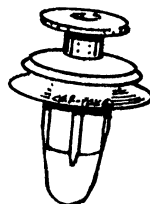
**81-5415**

Replaces: 67771-12010-F,
 9927-40-825, 894226 4920
 Hole: M8.5, P.R.: 0.80MM
CLIP-TRIM PANEL
 Toyota, Mazda, Isuzu
UNIT PACKAGE 25

**97-7715**

Replaces: 67771-30090
CLIP-DOOR TRIM PANEL
 Plastic
 Hole: M9, Stem Lgth: 17MM
 Lexus LX 450 '96-'97
 Toyota Land Cruiser '91-'97
UNIT PACKAGE 15

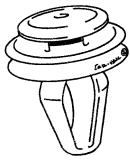
**97-7707**

Replaces: 67771-30070
CLIP-DOOR TRIM PANEL
 Plastic w/Seal
 Hole: M9, Stem Lgth: 11MM
 Toyota Cars & Trucks '92/, Scion xB 2004/
UNIT PACKAGE 15

**97-7673**

Replaces: 95008221, 67771-12050,
 67771-16080, 67771-02030, 67771-12040
RETAINER- DOOR TRIM, HEADLINER
 Plastic
 Hole Dia: M9
 Lexus '96/, Geo, Prism '93/
 Toyota Car & Truck '88/, Scion 2004/
UNIT PACKAGE 50

**99-8172**

Replaces: 67771-20110
RETAINER-DOOR PANEL
 Plastic with sealer
 Hole: M9, Flange: 18MM,
 Top Head: 13MM, Stem Lgth: 15.5MM
 Toyota Rav4, T 100 Pick Up '93/
UNIT PACKAGE 15

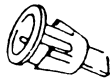
**89-6635**

Replaces: 90467-05012
NUT-RETAINER TUBULAR
 Plastic
 M6 Hole, Name Plates & Emblems
 Toyota
UNIT PACKAGE 25

**85-5966**

Replaces: 90520-01274
CLIP-WINDOW CRANK HANDLE
 Retaining
 Toyota
UNIT PACKAGE 50

**97-7709**

Replaces: 90467-07096
CLIP-TRIM PANEL
 Plastic
 Hole: M6, Head: 16MM,
 Stem Lgth: 10.5MM
 Toyota Trk 4wd '89/
UNIT PACKAGE 15

**90-6807**

Replaces: 96057847
 09409-07313, 90467-07313
RIVET-DRIVE TYPE
RADIATOR GRILLE RETAINER,
DOOR PANEL
 Hole: M7, Washer: 11MM, P.R.: 7-10MM
 Plastic
 Toyota 4 Runner & Camry
 G.M. Geo Tracker '89/
 Suzuki Sidekick '89/
UNIT PACKAGE 10

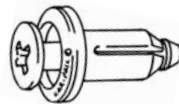
**99-8799**

Replaces: 90467-07190-B2
RIVET-DRIVE TYPE (Twist to Release)
DOOR TRIM
 Plastic-Textured
 Hole: M7, Flange: 14MM,
 Stem Lgth: 11.5MM, P.R.: 3.5-5MM
 Toyota Echo & Scion 2004/
UNIT PACKAGE 10

**99-8176**

Replaces: 90467-10016
RETAINER-HEADLINER
 Plastic - Textured Head, Paint to Match
 Hole: M8, Head: 18MM,
 Stem Lgth.: 15MM
 Toyota Rav4 '96/
UNIT PACKAGE 15

**97-7712**

Replaces: 90467-08122
CLIP-HEADLINER
 Plastic
 Hole: M8, Head Dia: 15MM
 Stem Lgth: 12MM
 Toyota Tacoma & T-100 '92/
UNIT PACKAGE 15

**99-8175**

Replaces: 90467-06070
RETAINER - HEADLINER
 Plastic - Textured Head, Paint to match
 Hole: M5, Hd: 25MM
 Stem Length: 17MM
 Toyota RAV 4, Land Cruiser '91/
 Lexus LX450 '96-'97
UNIT PACKAGE 25

**99-8151**

Replaces: 90467-08186
RETAINER - TRIM PANEL
 Interior Trunk & Quarter Panels
 Plastic
 Hole: M7, Head: 16MM,
 Stem Length: 16MM, O/L: 19.5MM
 Toyota Camry, Lexus ES300,
 GS300/400, RX300 '97/
UNIT PACKAGE 15

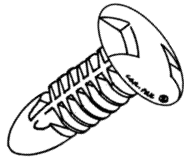
**99-8274**

Replaces: 90467-06175
RETAINER - TRUNK TRIM
 Plastic

Hole: M6, Hd: 16MM, P.R.: 1.5-8.0MM
 Stem Length: 16MM, O/L: 19.5MM
 Toyota Camry, Solara & Lexus ES300 '97/
UNIT PACKAGE 15

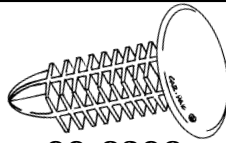
**99-8398**

Replaces: 88970656,
 90467-05020
**RETAINER-ROCKER PANEL &
 INTERIOR TRIM**
 Plastic

Hole: M5, Head:16MM,
 Stem Lgth: 16MM, P.R.: 1.5-10MM
 Pontiac Vibe 2003,
 Toyota Celica '94-99 & Lexus RX300 '99/
UNIT PACKAGE 50

**96-7526**

Replaces: 01553-00755, 80999-05N07,
 90467-07043

**RIVET-DRIVE TYPE
 DECK TRIM**

Hole: 7MM Head Dia.: 18MM
 Stem Length: 11MM
 Nissan & Toyota '93-'98
UNIT PACKAGE 15

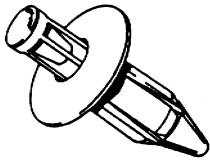
**99-8079**

Replaces: 90467-07085
RETAINER-DOOR PANEL
 Hole: M6.3, Flange: 18MM,
 Stem Lgth: 9MM
 Plastic (Push to release style)
 Toyota Camry, Rav 4,
 4 Runner & Tacoma '95/
UNIT PACKAGE 25

**99-8357**

Replaces: 88970494, 88973676,
 90467-07168

RIVET - PIN DRIVE (TWIST TO RELEASE)
 Rocker & Garnish Moulding
 Plastic

Hole: M7, Flange: 20MM,
 Stem Lgth: 8.5MM, P.R.: 5MM
 Pontiac Vibe 2003 & Toyota/Lexus 2000/
UNIT PACKAGE 15

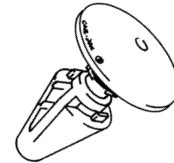
**99-8283**

Replaces: 75867-30110
RETAINER - ROCKER MOULDING
 Plastic
 Hole: M9, Hd: 18MM, O/L: 23.5MM,
 Toyota Avalon, Corolla '97/ &
 Lexus ES300/SC400 '97-2001
UNIT PACKAGE 15

**99-8358**

Replaces: 88970495,88973654,
 76924-02010, 76924-52021
RETAINER - ROCKER MOULDING, Plastic
 Hole: M21.5, Flange: 32MM,
 O/L: 12.5MM,
 Pontiac Vibe 2003 & Toyota 2003/,
 Scion 2004/
UNIT PACKAGE 25

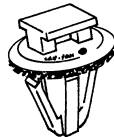
**99-8171**

Replaces: 62955-12010, 94848834
**RETAINER-RADIATOR GRILLE, TRUNK
 PANEL, BACK GLASS LOUVER**
 Plastic - with sealer
 Hole: M8, Flange: 15MM, Head: 8MM Sq.
 Toyota Corolla, Rav4 '88/
 Lexus ES300 '92-'96 & Pontiac Vibe 2003/
UNIT PACKAGE 10

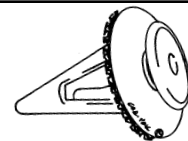
**99-8282**

Replaces: 67771-12070
**RETAINER - DOOR PANEL &
 ROCKER MOULDING**
 Plastic w/Seal
 Hole: M9, Upper Hd: 13MM,
 P.R.: 1.5MM, O/L: 19.7MM,
 Trim Thk.: 2.5MM
 Toyota Avalon, Corolla '93/ &
 Lexus SC300/400 '92-2000
UNIT PACKAGE 15

**99-8375**

Replaces: 90467-10162
**RETAINER - ROCKER MOULDING
 & SCUFF PLATE**
 Plastic
 Hole: M8.5, Hd: 13MM, O/L: 17MM,
 Trim Thk: 2MM, P.R.: 1.5MM
 Toyota Cars & Trucks 2000/
 Lexus ES300, RX300 & SC430 '99/
UNIT PACKAGE 25

**99-8359**

Replaces: 67771-12080
**RETAINER - DOOR PANEL & ROCKER
 MOULDING**
 Plastic - 2 Piece, Yellow Pin,
 White Grommet
 Hole: M8, Upper Hd: 13MM, P.R.: 1MM,
 O/L: 20MM, Trim Thk: 3MM
 Toyota & Lexus '98/
UNIT PACKAGE 15

2-PART

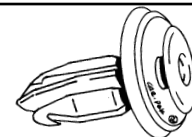
**99-8360**

Replaces: 94178705, 94858299,
 90467-10161
RETAINER - ROCKER MOULDING
 Plastic
 Hole: M8.5, Upper Hd:
 13MM, O/L: 20MM,
 Trim Thk: 2.6MM, P.R.: 0.7-1.6
 Pontiac Vibe 2003/,
 Lexus & Toyota '98/, Scion 2004/
UNIT PACKAGE 50

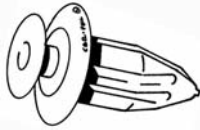
**99-8678**

Replaces: 75867-AA010
**RETAINER-ROCKER PANEL
 & SCUFF PLATE**, Plastic
 Hole: M8, Head: 13MM,
 Trim Thk: 2.5MM, O/L: 18MM
 Toyota Avalon, Camry, Solara 2004/
 Scion xA 2004/
 Lexus ES300/330 2002/
UNIT PACKAGE 15

**76-4334**

Replaces: 90189-05013
 MS-480-002
**NUT-HEADLAMP BEZEL
 & GRILLE**
 Toyota, Mitsubishi
UNIT PACKAGE 100

**81-5418**

Replaces: 90189-04016
NUT-ANCHOR TYPE
 Plastic, Toyota
UNIT PACKAGE 25

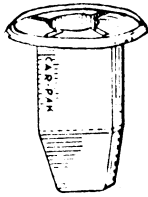
**81-5293**

Replaces: 01651-00481
 MS 480012
CLIP-GENERAL PURPOSE
 9mm Sq. Hole
 Toyota, Mitsubishi '78/
UNIT PACKAGE 25

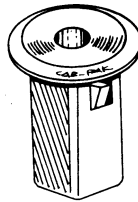
**83-5705**

Replaces: 90189-06005,
 098-145, 01281-00023
CLIP-BODY MOULDING
 M.6.3 Screw
 Toyota, Mitsubishi, Datsun
UNIT PACKAGE 25

**81-5419**

Replaces: 90189-04013
NUT-ANCHOR TYPE
 Plastic, 7mm sq. Hole
 Toyota
UNIT PACKAGE 25

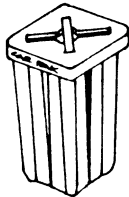
**81-5424**

Replaces: 90189-04007
CLIP-ANCHOR TYPE
 7.2mm Sq. Hole, Plastic
 Toyota
UNIT PACKAGE 25

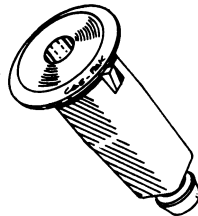
**83-5692**

Replaces: 90189-06003
CLIP-BODY SIDE MOULDING
 Toyota
UNIT PACKAGE 25

**82-5570**

Replaces: 01281-00072
 90185-04014
NUT-ANCHOR
 Datsun, Toyota
UNIT PACKAGE 50

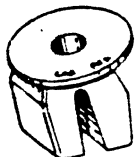
**82-5571**

Replaces: 01281-00111
 96185-06006
NUT-ANCHOR
 Datsun, Toyota
UNIT PACKAGE 50

**82-5534**

Replaces: 96706-P0105
 90189-06010
NUT-GENERAL PURPOSE
 Datsun, Toyota
UNIT PACKAGE 50

**98-7894**

Replaces: 90189-05012
 8941-340-270
NUT-WIDE RANGE
 M4.2 Screw
 Formerly 85-5979
 Plastic, Various Applications
 Isuzu, Lexus & Toyota '87-'91
UNIT PACKAGE 25

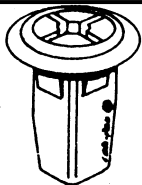
**87-6324**Replaces: 01281-00023, 90189-06001,
MB098145**GROMMET NUT**

Plastic

M.S. Screw; M8.5, Head Dia.: 18MM

Nissan Applications '86/

Toyota & Mitsubishi

UNIT PACKAGE 25

**84-5773**

Replaces: 90662-693-003, 90189-04066

**NUT GROMMET-REAR QUARTER
PANEL MOULDING & GENERAL USAGE**

Plastic, w/Seal

Screw: M4

Honda Accord '82/, Toyota

UNIT PACKAGE 25

**99-8021**

Replaces: 90189-06018

**GROMMET-ROCKER PANEL,
WHEEL OPENING**

Plastic

Hole: M9 sq., Flange: 14MM sq.,

PR: 2.5MM, Screw: M4.2

Lexus 2003/, Toyota '96/, Scion 2004/

UNIT PACKAGE 15

**98-7767**

Replaces: 90467-07151

RETAINER-LUGGAGE**COMPARTMENT TRIM**

Plastic

Hole: M6, Head: 18MM, P.R.: 2.5-7MM

Toyota

UNIT PACKAGE 15

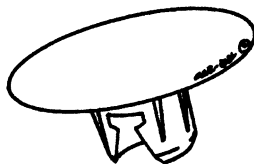
**98-7768**

Replaces: 90467-05085

CLIP-LUGGAGE COMPARTMENT TRIM

Plastic

Fits: M5 Stud, Head Dia.: 21MM

Toyota Camry '92/'96, Lexus ES300 '95/

UNIT PACKAGE 10

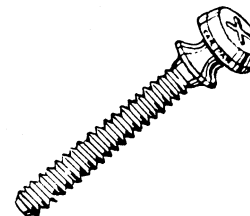
**80-5237**

Replaces: 26022-H1010

SCREW-HEADLAMP ADJUSTING

Nissan, Toyota

UNIT PACKAGE 25

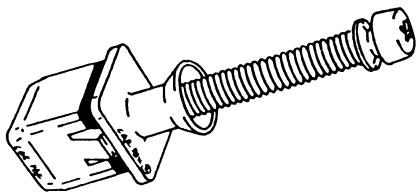
**89-6710**

Replaces: 81195-89101

SCREW-HEADLAMP ADJUSTING**ASSEMBLY**

Screw w/Nut M5x50mm

Plastic Nut M5

Toyota Pick-Up '84/

UNIT PACKAGE 15

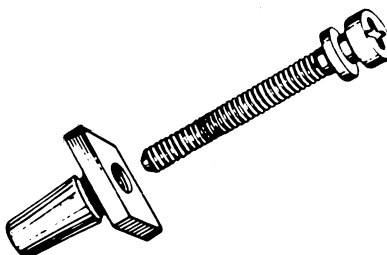
**71-3505***(Not supplied by O.E.)***NUT & SCREW-HEADLAMP ADJUSTING**

Datsun, Toyota '69-'72

UNIT PACKAGE 25

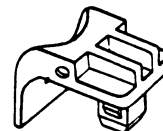
**87-6268**

Replaces: 81124-89101

SPACER-HEADLAMP

Plastic

Hole: M7

Toyota Pick-Up '84/

UNIT PACKAGE 25

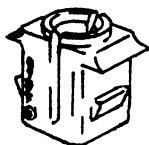
**95-7396***(Not supplied by O.E.)***NUT-HEADLAMP ADJUSTING**

Plastic

Hole: 11mm x12.5mm

Toyota Camry '94/

UNIT PACKAGE 15

**98-7909**Replaces: N811169-S, W705550-S300,
90189-06111**RETAINER-PARK & TURN SIGNAL
HOUSING, HEADLAMP MOUNTING**

Plastic, w/Aero Style Lamps

Hole: M10.5, Head: 13MM

Ford F250-F550 '99/, Toyota & Lexus '89/

UNIT PACKAGE 50

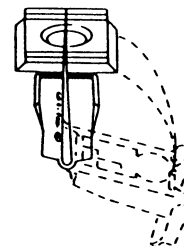
**89-6704**

Replaces: 81153-22520

BEARING CLIP-HEADLAMP ADJUSTER

Plastic

Toyota Cressida '85

UNIT PACKAGE 25

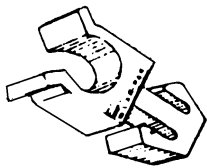

95-7466
 Replaces: 53452-90351
CLIP-HOOD ROD PROP
 6mm x 7mm Rod Dia.:
 Toyota Car & Truck '91/
UNIT PACKAGE 5

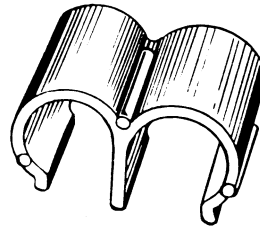

82-5583
 Replaces: 90464-00082
 90044-64012
CLIP-PIPE CLAMP
 Dia.: M6
 Toyota & Lexus
UNIT PACKAGE 25

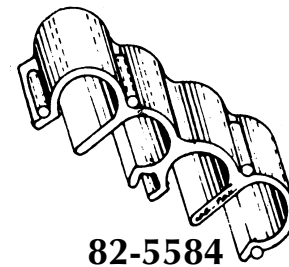

82-5584
 Replaces: 90464-00081
 18411-74000, 70474-00081
CLIP-PIPE CLAMP
 Dia.: M6
 Toyota & Others
UNIT PACKAGE 25

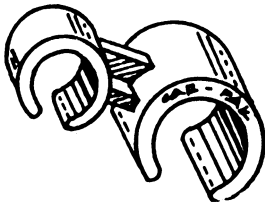

82-5585
 Replaces: 90464-00231
CLIP-PIPE CLAMP
 Dia.: M10, M11
 Toyota
UNIT PACKAGE 25

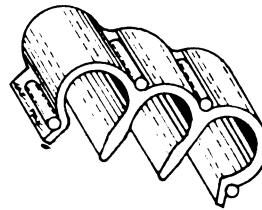

82-5586
 Replaces: 90464-00074
 18412-74000, 18412-00074
CLIP-PIPE CLAMP
 Dia.: M6
 Toyota, Lexus & Others
UNIT PACKAGE 25

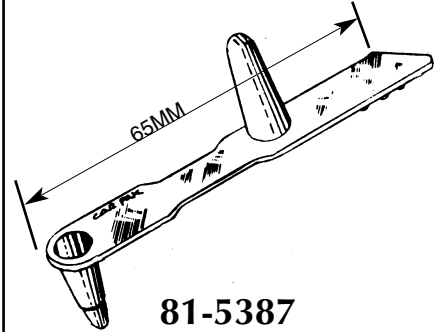

81-5387
 Replaces: 90463-10335
CLIP-WIRING
 Toyota
UNIT PACKAGE 25

REPLACED BY & DISCONTINUED FROM CAR-PAK 2005 & JOBBER 2001 CATALOGS

| OLD CATALOG | | NEW CATALOG | PAGE NO. |
|-------------|--------------|-------------|----------|
| 224 | DISCONTINUED | --- | --- |
| 254 | DISCONTINUED | --- | --- |
| 295 | DISCONTINUED | --- | --- |
| 296 | DISCONTINUED | --- | --- |
| 64-1008 | DISCONTINUED | --- | --- |
| 65-1076 | REPLACED BY | B-7722 | 495 |
| 65-1107 | DISCONTINUED | --- | --- |
| 65-1125 | DISCONTINUED | --- | --- |
| 65-1132 | DISCONTINUED | --- | --- |
| 65-1133 | DISCONTINUED | --- | --- |
| 65-1135 | DISCONTINUED | --- | --- |
| 66-1154 | DISCONTINUED | --- | --- |
| 66-1157 | DISCONTINUED | --- | --- |
| 66-3008 | DISCONTINUED | --- | --- |
| 66-3009 | DISCONTINUED | --- | --- |
| 66-3011 | DISCONTINUED | --- | --- |
| 66-3027 | DISCONTINUED | --- | --- |
| 67-3108 | DISCONTINUED | --- | --- |
| 67-3116 | DISCONTINUED | --- | --- |
| 67-3117 | DISCONTINUED | --- | --- |
| 67-3131 | DISCONTINUED | --- | --- |
| 68-3178 | DISCONTINUED | --- | --- |
| 68-3200 | DISCONTINUED | --- | --- |
| 68-3203 | DISCONTINUED | --- | --- |
| 68-3218 | DISCONTINUED | --- | --- |
| 68-3221 | DISCONTINUED | --- | --- |
| 68-3228 | DISCONTINUED | --- | --- |
| 68-3229 | DISCONTINUED | --- | --- |
| 68-3248 | DISCONTINUED | --- | --- |
| 68-3251 | DISCONTINUED | --- | --- |
| 69-2053 | DISCONTINUED | --- | --- |
| 69-2054 | DISCONTINUED | --- | --- |
| 69-3260 | DISCONTINUED | --- | --- |
| 69-3272 | DISCONTINUED | --- | --- |
| 69-3282 | DISCONTINUED | --- | --- |
| 69-3294 | DISCONTINUED | --- | --- |

| OLD CATALOG | | NEW CATALOG | PAGE NO. |
|-------------|--------------|-------------|----------|
| 69-3295 | DISCONTINUED | --- | --- |
| 69-3296 | DISCONTINUED | --- | --- |
| 69-3299 | DISCONTINUED | --- | --- |
| 69-3324 | DISCONTINUED | --- | --- |
| 70-3335 | DISCONTINUED | --- | --- |
| 70-3337 | DISCONTINUED | --- | --- |
| 70-3353 | DISCONTINUED | --- | --- |
| 70-3368 | DISCONTINUED | --- | --- |
| 70-3370 | REPLACED BY | 99-8126 | 72 |
| 70-3381 | DISCONTINUED | --- | --- |
| 70-3392 | DISCONTINUED | --- | --- |
| 70-3418 | DISCONTINUED | --- | --- |
| 71-3440 | DISCONTINUED | --- | --- |
| 71-3483 | REPLACED BY | SC-3345 | 78 |
| 71-3527 | REPLACED BY | 71-3453 | 263 |
| 71-3528 | DISCONTINUED | --- | --- |
| 71-3531 | DISCONTINUED | --- | --- |
| 71-3538 | DISCONTINUED | --- | --- |
| 71-3551 | REPLACED BY | 99-8438 | 93 |
| 71-3560 | DISCONTINUED | --- | --- |
| 72-3575 | DISCONTINUED | --- | --- |
| 72-3577 | DISCONTINUED | --- | --- |
| 72-3582 | DISCONTINUED | --- | --- |
| 72-3589 | DISCONTINUED | --- | --- |
| 72-3597 | DISCONTINUED | --- | --- |
| 72-3617 | DISCONTINUED | --- | --- |
| 72-3618 | DISCONTINUED | --- | --- |
| 72-3644 | DISCONTINUED | --- | --- |
| 72-3663 | DISCONTINUED | --- | --- |
| 72-3680 | DISCONTINUED | --- | --- |
| 72-3715 | DISCONTINUED | --- | --- |
| 72-3720 | DISCONTINUED | --- | --- |
| 72-3725 | DISCONTINUED | --- | --- |
| 73-3802 | REPLACED BY | SC-3345 | 78 |
| 73-3831 | DISCONTINUED | --- | --- |
| 73-3875 | DISCONTINUED | --- | --- |

| OLD CATALOG | | NEW CATALOG | PAGE NO. |
|-------------|--------------|-------------|----------|
| 73-3911 | DISCONTINUED | --- | --- |
| 73-3927 | DISCONTINUED | --- | --- |
| 74-3939 | DISCONTINUED | --- | --- |
| 74-3953 | DISCONTINUED | --- | --- |
| 74-3968 | DISCONTINUED | --- | --- |
| 74-4053 | DISCONTINUED | --- | --- |
| 74-4054 | DISCONTINUED | --- | --- |
| 74-4058 | DISCONTINUED | --- | --- |
| 74-4092 | DISCONTINUED | --- | --- |
| 74-4094 | DISCONTINUED | --- | --- |
| 74-4096 | DISCONTINUED | --- | --- |
| 75-4102 | DISCONTINUED | --- | --- |
| 75-4149 | DISCONTINUED | --- | --- |
| 75-4150 | DISCONTINUED | --- | --- |
| 75-4173 | DISCONTINUED | --- | --- |
| 75-4184 | REPLACED BY | 97-7633 | 73 |
| 75-4203 | DISCONTINUED | --- | --- |
| 75-4204 | DISCONTINUED | --- | --- |
| 75-4215 | DISCONTINUED | --- | --- |
| 75-4230 | DISCONTINUED | --- | --- |
| 75-4231 | DISCONTINUED | --- | --- |
| 75-4232 | DISCONTINUED | --- | --- |
| 76-2092 | DISCONTINUED | --- | --- |
| 76-4243 | DISCONTINUED | --- | --- |
| 76-4249 | DISCONTINUED | --- | --- |
| 76-4305 | DISCONTINUED | --- | --- |
| 76-4423 | DISCONTINUED | --- | --- |
| 77-4464 | DISCONTINUED | --- | --- |
| 77-4472 | DISCONTINUED | --- | --- |
| 77-4492 | DISCONTINUED | --- | --- |
| 77-4498 | DISCONTINUED | --- | --- |
| 77-4585 | DISCONTINUED | --- | --- |
| 77-4587 | DISCONTINUED | --- | --- |
| 77-4604 | DISCONTINUED | --- | --- |
| 77-4652 | DISCONTINUED | --- | --- |
| 77-4664 | DISCONTINUED | --- | --- |

REPLACED BY & DISCONTINUED FROM CAR-PAK 2005 & JOBBER 2001 CATALOGS

| OLD CATALOG | NEW PAGE CATALOG NO. | OLD CATALOG | NEW PAGE CATALOG NO. | OLD CATALOG | NEW PAGE CATALOG NO. |
|-------------|-------------------------|-------------|------------------------|-------------|-------------------------|
| 77-4665 | DISCONTINUED --- | 83-5670 | DISCONTINUED --- | 91-6929 | DISCONTINUED --- |
| 77-4681 | DISCONTINUED --- | 83-5671 | DISCONTINUED --- | 91-6940 | DISCONTINUED --- |
| 77-4682 | DISCONTINUED --- | 83-5673 | DISCONTINUED --- | 91-6947 | DISCONTINUED --- |
| 77-4702 | DISCONTINUED --- | 83-5730 | DISCONTINUED --- | 91-6957 | DISCONTINUED --- |
| 77-4729 | DISCONTINUED --- | 84-5765 | DISCONTINUED --- | 91-6961 | DISCONTINUED --- |
| 78-4741 | DISCONTINUED --- | 84-5796 | DISCONTINUED --- | 91-6969 | DISCONTINUED --- |
| 78-4755 | DISCONTINUED --- | 84-5797 | DISCONTINUED --- | 92-7069 | REPLACED BY 99-8549 75 |
| 78-4809 | REPLACED BY 71-3453 263 | 84-5815 | DISCONTINUED --- | 93-7116 | DISCONTINUED --- |
| 78-4811 | DISCONTINUED --- | 84-5843 | DISCONTINUED --- | 93-7120 | DISCONTINUED --- |
| 78-4820 | DISCONTINUED --- | 84-5870 | DISCONTINUED --- | 93-7124 | DISCONTINUED --- |
| 78-4856 | DISCONTINUED --- | 84-5876 | DISCONTINUED --- | 93-7134 | DISCONTINUED --- |
| 78-4871 | DISCONTINUED --- | 85-5886 | DISCONTINUED --- | 93-7156 | DISCONTINUED --- |
| 78-4899 | DISCONTINUED --- | 85-5939 | REPLACED BY 93-7138 68 | 93-7158 | DISCONTINUED --- |
| 78-4930 | DISCONTINUED --- | 85-5995 | DISCONTINUED --- | 93-7162 | REPLACED BY 78-4849 523 |
| 78-4932 | DISCONTINUED --- | 86-6012 | DISCONTINUED --- | 93-7171 | DISCONTINUED --- |
| 78-4935 | DISCONTINUED --- | 86-6026 | DISCONTINUED --- | 93-7183 | DISCONTINUED --- |
| 78-4938 | DISCONTINUED --- | 86-6036 | DISCONTINUED --- | 94-7220 | DISCONTINUED --- |
| 78-4961 | DISCONTINUED --- | 86-6065 | DISCONTINUED --- | 94-7225 | DISCONTINUED --- |
| 78-4962 | DISCONTINUED --- | 86-6066 | DISCONTINUED --- | 94-7239 | DISCONTINUED --- |
| 78-4968 | DISCONTINUED --- | 86-6093 | DISCONTINUED --- | 94-7261 | DISCONTINUED --- |
| 79-4998 | DISCONTINUED --- | 86-6139 | DISCONTINUED --- | 94-7271 | DISCONTINUED --- |
| 79-5014 | REPLACED BY 78-4796 135 | 86-6144 | DISCONTINUED --- | 94-7272 | DISCONTINUED --- |
| 79-5039 | DISCONTINUED --- | 86-6146 | DISCONTINUED --- | 94-7276 | DISCONTINUED --- |
| 79-5041 | DISCONTINUED --- | 86-6154 | DISCONTINUED --- | 94-7285 | DISCONTINUED --- |
| 79-5044 | DISCONTINUED --- | 86-6155 | DISCONTINUED --- | 94-7287 | DISCONTINUED --- |
| 79-5056 | DISCONTINUED --- | 86-6157 | DISCONTINUED --- | 94-7311 | REPLACED BY 99-8791 185 |
| 79-5070 | DISCONTINUED --- | 86-6158 | DISCONTINUED --- | 94-7332 | DISCONTINUED --- |
| 79-5077 | DISCONTINUED --- | 86-6176 | DISCONTINUED --- | 94-7337 | DISCONTINUED --- |
| 79-5080 | DISCONTINUED --- | 86-6178 | DISCONTINUED --- | 94-7350 | DISCONTINUED --- |
| 79-5084 | DISCONTINUED --- | 87-6239 | DISCONTINUED --- | 94-7354 | DISCONTINUED --- |
| 79-5094 | DISCONTINUED --- | 87-6276 | DISCONTINUED --- | 94-7357 | DISCONTINUED --- |
| 79-5098 | DISCONTINUED --- | 87-6283 | DISCONTINUED --- | 95-7365 | DISCONTINUED --- |
| 79-5123 | DISCONTINUED --- | 87-6303 | DISCONTINUED --- | 95-7384 | DISCONTINUED --- |
| 79-5137 | DISCONTINUED --- | 87-6316 | DISCONTINUED --- | 95-7407 | DISCONTINUED --- |
| 79-5140 | DISCONTINUED --- | 87-6335 | DISCONTINUED --- | 95-7424 | DISCONTINUED --- |
| 80-5145 | DISCONTINUED --- | 87-6339 | DISCONTINUED --- | 95-7432 | DISCONTINUED --- |
| 80-5164 | DISCONTINUED --- | 87-6345 | DISCONTINUED --- | 95-7433 | DISCONTINUED --- |
| 80-5185 | DISCONTINUED --- | 88-6396 | DISCONTINUED --- | 95-7435 | DISCONTINUED --- |
| 80-5212 | DISCONTINUED --- | 88-6399 | DISCONTINUED --- | 95-7438 | DISCONTINUED --- |
| 80-5213 | DISCONTINUED --- | 88-6456 | DISCONTINUED --- | 95-7441 | DISCONTINUED --- |
| 80-5222 | DISCONTINUED --- | 88-6479 | DISCONTINUED --- | 95-7455 | DISCONTINUED --- |
| 80-5224 | DISCONTINUED --- | 88-6500 | DISCONTINUED --- | 95-7485 | DISCONTINUED --- |
| 80-5247 | REPLACED BY 99-8663 475 | 88-6505 | DISCONTINUED --- | 96-7522 | DISCONTINUED --- |
| 80-5258 | DISCONTINUED --- | 88-6530 | DISCONTINUED --- | 96-7523 | DISCONTINUED --- |
| 81-5302 | DISCONTINUED --- | 88-6539 | DISCONTINUED --- | 96-7557 | DISCONTINUED --- |
| 81-5309 | DISCONTINUED --- | 88-6545 | DISCONTINUED --- | 96-7612 | DISCONTINUED --- |
| 81-5329 | DISCONTINUED --- | 89-6553 | DISCONTINUED --- | 97-7617 | DISCONTINUED --- |
| 81-5334 | DISCONTINUED --- | 89-6555 | DISCONTINUED --- | 97-7637 | DISCONTINUED --- |
| 81-5336 | DISCONTINUED --- | 89-6556 | DISCONTINUED --- | 97-7643 | DISCONTINUED --- |
| 81-5337 | DISCONTINUED --- | 89-6557 | DISCONTINUED --- | 97-7645 | DISCONTINUED --- |
| 81-5338 | DISCONTINUED --- | 89-6558 | DISCONTINUED --- | 97-7646 | DISCONTINUED --- |
| 81-5342 | DISCONTINUED --- | 89-6559 | DISCONTINUED --- | 97-7671 | DISCONTINUED --- |
| 81-5359 | DISCONTINUED --- | 89-6560 | DISCONTINUED --- | 97-7678 | DISCONTINUED --- |
| 81-5368 | DISCONTINUED --- | 89-6562 | DISCONTINUED --- | 97-7703 | DISCONTINUED --- |
| 81-5371 | DISCONTINUED --- | 89-6564 | DISCONTINUED --- | 97-7749 | DISCONTINUED --- |
| 81-5383 | DISCONTINUED --- | 89-6566 | DISCONTINUED --- | 97-7753 | DISCONTINUED --- |
| 81-5384 | DISCONTINUED --- | 89-6567 | DISCONTINUED --- | 98-7796 | DISCONTINUED --- |
| 81-5396 | DISCONTINUED --- | 89-6610 | DISCONTINUED --- | 98-7797 | DISCONTINUED --- |
| 81-5397 | DISCONTINUED --- | 89-6643 | DISCONTINUED --- | 98-7813 | DISCONTINUED --- |
| 81-5400 | DISCONTINUED --- | 89-6651 | DISCONTINUED --- | 98-7868 | DISCONTINUED --- |
| 81-5402 | DISCONTINUED --- | 89-6664 | DISCONTINUED --- | 98-7896 | DISCONTINUED --- |
| 81-5403 | DISCONTINUED --- | 89-6682 | DISCONTINUED --- | 99-7921 | DISCONTINUED --- |
| 81-5417 | DISCONTINUED --- | 89-6688 | DISCONTINUED --- | 99-7981 | DISCONTINUED --- |
| 81-5432 | DISCONTINUED --- | 89-6691 | DISCONTINUED --- | 99-7982 | DISCONTINUED --- |
| 81-5456 | DISCONTINUED --- | 89-6701 | DISCONTINUED --- | 99-7983 | DISCONTINUED --- |
| 82-5497 | DISCONTINUED --- | 89-6719 | DISCONTINUED --- | 99-8015 | DISCONTINUED --- |
| 82-5507 | DISCONTINUED --- | 90-6723 | DISCONTINUED --- | 99-8047 | DISCONTINUED --- |
| 82-5514 | DISCONTINUED --- | 90-6731 | DISCONTINUED --- | 99-8059 | DISCONTINUED --- |
| 82-5515 | DISCONTINUED --- | 90-6737 | DISCONTINUED --- | 99-8124 | REPLACED BY 99-8410 227 |
| 82-5531 | DISCONTINUED --- | 90-6745 | DISCONTINUED --- | 99-8188 | REPLACED BY 99-8684 586 |
| 82-5532 | DISCONTINUED --- | 90-6747 | DISCONTINUED --- | 99-8213 | DISCONTINUED --- |
| 82-5546 | DISCONTINUED --- | 90-6775 | DISCONTINUED --- | 99-8243 | DISCONTINUED --- |
| 82-5582 | DISCONTINUED --- | 90-6785 | DISCONTINUED --- | 99-8300 | DISCONTINUED --- |
| 82-5603 | DISCONTINUED --- | 90-6796 | DISCONTINUED --- | 99-8332 | DISCONTINUED --- |
| 82-5606 | DISCONTINUED --- | 90-6849 | DISCONTINUED --- | 99-8403 | DISCONTINUED --- |
| 83-5610 | DISCONTINUED --- | 90-6866 | DISCONTINUED --- | 99-8422 | DISCONTINUED --- |
| 83-5611 | DISCONTINUED --- | 91-6891 | DISCONTINUED --- | 99-8466 | REPLACED BY 99-8748 115 |

REPLACED BY & DISCONTINUED FROM CAR-PAK 2005 & JOBBER 2001 CATALOGS

| OLD CATALOG | | NEW PAGE CATALOG NO. | OLD CATALOG | | NEW PAGE CATALOG NO. | OLD CATALOG | | NEW PAGE CATALOG NO. |
|-------------|--------------|----------------------|-------------|--------------|----------------------|-------------|--------------|----------------------|
| 99-8505 | DISCONTINUED | --- | J01031 | DISCONTINUED | --- | J02488 | DISCONTINUED | --- |
| AN999 | DISCONTINUED | --- | J01033 | DISCONTINUED | --- | J02600 | DISCONTINUED | --- |
| B-7402 | REPLACED BY | B-7722 495 | J01034 | REPLACED BY | 70-3386 268 | J02609 | DISCONTINUED | --- |
| CS-10119 | DISCONTINUED | --- | J01047 | DISCONTINUED | --- | J02615 | DISCONTINUED | --- |
| CS-10122 | DISCONTINUED | --- | J01077 | DISCONTINUED | --- | J02641 | DISCONTINUED | --- |
| CS-10125 | DISCONTINUED | --- | J01150 | DISCONTINUED | --- | J02642 | DISCONTINUED | --- |
| DLRR-102 | DISCONTINUED | --- | J01236 | DISCONTINUED | --- | J02644 | DISCONTINUED | --- |
| J00097 | DISCONTINUED | --- | J01450 | DISCONTINUED | --- | J02645 | DISCONTINUED | --- |
| J00104 | DISCONTINUED | --- | J01535 | REPLACED BY | 99-8672 474 | J02646 | DISCONTINUED | --- |
| J00111 | DISCONTINUED | --- | J01701 | DISCONTINUED | --- | J02675 | DISCONTINUED | --- |
| J00124 | DISCONTINUED | --- | J01704 | DISCONTINUED | --- | J03054 | DISCONTINUED | --- |
| J00133 | DISCONTINUED | --- | J01749 | DISCONTINUED | --- | J03064 | DISCONTINUED | --- |
| J00176 | DISCONTINUED | --- | J01752 | DISCONTINUED | --- | J03069 | DISCONTINUED | --- |
| J00231 | DISCONTINUED | --- | J01753 | DISCONTINUED | --- | J03072 | DISCONTINUED | --- |
| J00233 | DISCONTINUED | --- | J01800 | DISCONTINUED | --- | J03080 | DISCONTINUED | --- |
| J00256 | DISCONTINUED | --- | J01803 | DISCONTINUED | --- | J03090 | DISCONTINUED | --- |
| J00263 | DISCONTINUED | --- | J01810 | REPLACED BY | 67-3111 264 | J03144 | DISCONTINUED | --- |
| J00278 | DISCONTINUED | --- | J01821 | DISCONTINUED | --- | J03174 | DISCONTINUED | --- |
| J00279 | DISCONTINUED | --- | J01829 | DISCONTINUED | --- | J03242 | REPLACED BY | J33242 533 |
| J00282 | DISCONTINUED | --- | J01831 | DISCONTINUED | --- | J03257 | REPLACED BY | J04404 530 |
| J00304 | DISCONTINUED | --- | J01839 | REPLACED BY | J02371 469 | J03280 | REPLACED BY | J03082 282 |
| J00329 | DISCONTINUED | --- | J01852 | DISCONTINUED | --- | J03310 | DISCONTINUED | --- |
| J00331 | DISCONTINUED | --- | J01871 | DISCONTINUED | --- | J03323 | DISCONTINUED | --- |
| J00340 | DISCONTINUED | --- | J01891 | DISCONTINUED | --- | J03324 | DISCONTINUED | --- |
| J00343 | DISCONTINUED | --- | J01893 | DISCONTINUED | --- | J03328 | DISCONTINUED | --- |
| J00350 | DISCONTINUED | --- | J01900 | DISCONTINUED | --- | J03335 | DISCONTINUED | --- |
| J00352 | DISCONTINUED | --- | J01901 | DISCONTINUED | --- | J03339 | DISCONTINUED | --- |
| J00361 | DISCONTINUED | --- | J01904 | DISCONTINUED | --- | J03367 | REPLACED BY | 99-8761 317 |
| J00363 | DISCONTINUED | --- | J01907 | DISCONTINUED | --- | J03390 | DISCONTINUED | --- |
| J00378 | DISCONTINUED | --- | J01925 | DISCONTINUED | --- | J03393 | DISCONTINUED | --- |
| J00382 | DISCONTINUED | --- | J01934 | DISCONTINUED | --- | J03401 | DISCONTINUED | --- |
| J00386 | DISCONTINUED | --- | J01948 | DISCONTINUED | --- | J03541 | DISCONTINUED | --- |
| J00394 | DISCONTINUED | --- | J01958 | DISCONTINUED | --- | J03571 | DISCONTINUED | --- |
| J00422 | DISCONTINUED | --- | J01959 | DISCONTINUED | --- | J03581 | DISCONTINUED | --- |
| J00423 | DISCONTINUED | --- | J02022 | DISCONTINUED | --- | J03641 | DISCONTINUED | --- |
| J00433 | DISCONTINUED | --- | J02030 | DISCONTINUED | --- | J03771 | DISCONTINUED | --- |
| J00444 | DISCONTINUED | --- | J02062 | DISCONTINUED | --- | J03868 | DISCONTINUED | --- |
| J00457 | DISCONTINUED | --- | J02081 | DISCONTINUED | --- | J03869 | DISCONTINUED | --- |
| J00459 | DISCONTINUED | --- | J02087 | DISCONTINUED | --- | J03881 | REPLACED BY | 99-8365 252 |
| J00464 | DISCONTINUED | --- | J02097 | DISCONTINUED | --- | J03886 | DISCONTINUED | --- |
| J00474 | DISCONTINUED | --- | J02108 | DISCONTINUED | --- | J03888 | DISCONTINUED | --- |
| J00478 | DISCONTINUED | --- | J02109 | DISCONTINUED | --- | J03898 | REPLACED BY | 71-3454 461 |
| J00479 | DISCONTINUED | --- | J02123 | DISCONTINUED | --- | J03902 | DISCONTINUED | --- |
| J00492 | DISCONTINUED | --- | J02127 | DISCONTINUED | --- | J03906 | DISCONTINUED | --- |
| J00493 | DISCONTINUED | --- | J02147 | DISCONTINUED | --- | J03975 | DISCONTINUED | --- |
| J00495 | DISCONTINUED | --- | J02153 | DISCONTINUED | --- | J03980 | DISCONTINUED | --- |
| J00496 | DISCONTINUED | --- | J02155 | DISCONTINUED | --- | J03981 | DISCONTINUED | --- |
| J00505 | DISCONTINUED | --- | J02161 | DISCONTINUED | --- | J03985 | DISCONTINUED | --- |
| J00526 | DISCONTINUED | --- | J02166 | DISCONTINUED | --- | J04018 | DISCONTINUED | --- |
| J00529 | DISCONTINUED | --- | J02180 | DISCONTINUED | --- | J04019 | DISCONTINUED | --- |
| J00538 | DISCONTINUED | --- | J02181 | DISCONTINUED | --- | J04040 | DISCONTINUED | --- |
| J00600 | DISCONTINUED | --- | J02182 | DISCONTINUED | --- | J04055 | DISCONTINUED | --- |
| J00685 | DISCONTINUED | --- | J02186 | DISCONTINUED | --- | J04059 | DISCONTINUED | --- |
| J00687 | DISCONTINUED | --- | J02198 | DISCONTINUED | --- | J04079 | DISCONTINUED | --- |
| J00691 | DISCONTINUED | --- | J02201 | DISCONTINUED | --- | J04081 | DISCONTINUED | --- |
| J00700 | REPLACED BY | 99-8416 397 | J02205 | DISCONTINUED | --- | J04082 | DISCONTINUED | --- |
| J00723 | DISCONTINUED | --- | J02229 | DISCONTINUED | --- | J04083 | DISCONTINUED | --- |
| J00754 | DISCONTINUED | --- | J02258 | DISCONTINUED | --- | J04084 | DISCONTINUED | --- |
| J00763 | DISCONTINUED | --- | J02259 | REPLACED BY | 99-8420 66 | J04092 | DISCONTINUED | --- |
| J00780 | DISCONTINUED | --- | J02261 | DISCONTINUED | --- | J04141 | DISCONTINUED | --- |
| J00782 | DISCONTINUED | --- | J02278 | DISCONTINUED | --- | J04143 | DISCONTINUED | --- |
| J00783 | DISCONTINUED | --- | J02308 | DISCONTINUED | --- | J04161 | DISCONTINUED | --- |
| J00786 | DISCONTINUED | --- | J02315 | DISCONTINUED | --- | J04193 | DISCONTINUED | --- |
| J00787 | DISCONTINUED | --- | J02321 | DISCONTINUED | --- | J04198 | DISCONTINUED | --- |
| J00795 | DISCONTINUED | --- | J02327 | DISCONTINUED | --- | J04199 | DISCONTINUED | --- |
| J00840 | DISCONTINUED | --- | J02328 | DISCONTINUED | --- | J04213 | DISCONTINUED | --- |
| J00882 | DISCONTINUED | --- | J02343 | DISCONTINUED | --- | J04214 | DISCONTINUED | --- |
| J00948 | DISCONTINUED | --- | J02346 | DISCONTINUED | --- | J04222 | DISCONTINUED | --- |
| J00954 | DISCONTINUED | --- | J02347 | DISCONTINUED | --- | J04272 | DISCONTINUED | --- |
| J00956 | DISCONTINUED | --- | J02349 | DISCONTINUED | --- | J04291 | DISCONTINUED | --- |
| J00957 | DISCONTINUED | --- | J02363 | DISCONTINUED | --- | J04293 | DISCONTINUED | --- |
| J00958 | DISCONTINUED | --- | J02367 | DISCONTINUED | --- | J04298 | DISCONTINUED | --- |
| J00971 | DISCONTINUED | --- | J02376 | DISCONTINUED | --- | J04299 | DISCONTINUED | --- |
| J00991 | DISCONTINUED | --- | J02437 | DISCONTINUED | --- | J04312 | DISCONTINUED | --- |
| J00995 | DISCONTINUED | --- | J02461 | REPLACED BY | 99-8424 66 | J04313 | DISCONTINUED | --- |
| J01002 | DISCONTINUED | --- | J02465 | DISCONTINUED | --- | J04326 | DISCONTINUED | --- |
| J01003 | DISCONTINUED | --- | J02483 | DISCONTINUED | --- | J04331 | DISCONTINUED | --- |

IMPORT PARTS



REPLACED BY & DISCONTINUED FROM CAR-PAK 2005 & JOBBER 2001 CATALOGS

| OLD CATALOG | | NEW CATALOG NO. | PAGE NO. | OLD CATALOG | | NEW CATALOG NO. | PAGE NO. | OLD CATALOG | | NEW CATALOG NO. | PAGE NO. |
|-------------|--------------|-----------------|----------|-------------|--------------|-----------------|----------|-------------|--------------|-----------------|----------|
| J04390 | DISCONTINUED | --- | --- | J05736 | DISCONTINUED | --- | --- | J06629 | DISCONTINUED | --- | --- |
| J04391 | REPLACED BY | J04404 | 530 | J05738 | DISCONTINUED | --- | --- | J06630 | DISCONTINUED | --- | --- |
| J04392 | REPLACED BY | J04405 | 530 | J05739 | DISCONTINUED | --- | --- | J06631 | DISCONTINUED | --- | --- |
| J04428 | DISCONTINUED | --- | --- | J05779 | DISCONTINUED | --- | --- | J06632 | DISCONTINUED | --- | --- |
| J04447 | REPLACED BY | 99-8245 | 66 | J05782 | DISCONTINUED | --- | --- | J06633 | DISCONTINUED | --- | --- |
| J04454 | DISCONTINUED | --- | --- | J05807 | REPLACED BY | 82-5483 | 183 | J06640 | DISCONTINUED | --- | --- |
| J04502 | DISCONTINUED | --- | --- | J05810 | REPLACED BY | 98-7807 | 130 | J06641 | DISCONTINUED | --- | --- |
| J04506 | DISCONTINUED | --- | --- | J05811 | DISCONTINUED | --- | --- | J06646 | DISCONTINUED | --- | --- |
| J04509 | DISCONTINUED | --- | --- | J05815 | DISCONTINUED | --- | --- | J06654 | DISCONTINUED | --- | --- |
| J04514 | DISCONTINUED | --- | --- | J05828 | DISCONTINUED | --- | --- | J06655 | DISCONTINUED | --- | --- |
| J04520 | REPLACED BY | 99-8245 | 66 | J05829 | DISCONTINUED | --- | --- | J06656 | DISCONTINUED | --- | --- |
| J04523 | REPLACED BY | 99-8425 | 65 | J05908 | DISCONTINUED | --- | --- | J06657 | DISCONTINUED | --- | --- |
| J04533 | DISCONTINUED | --- | --- | J05916 | DISCONTINUED | --- | --- | J06658 | DISCONTINUED | --- | --- |
| J04556 | DISCONTINUED | --- | --- | J05936 | DISCONTINUED | --- | --- | J06659 | DISCONTINUED | --- | --- |
| J04557 | DISCONTINUED | --- | --- | J05947 | DISCONTINUED | --- | --- | J06660 | DISCONTINUED | --- | --- |
| J04574 | DISCONTINUED | --- | --- | J05993 | DISCONTINUED | --- | --- | J06661 | DISCONTINUED | --- | --- |
| J04650 | DISCONTINUED | --- | --- | J06039 | DISCONTINUED | --- | --- | J06662 | DISCONTINUED | --- | --- |
| J04668 | DISCONTINUED | --- | --- | J06042 | DISCONTINUED | --- | --- | J06663 | DISCONTINUED | --- | --- |
| J04708 | REPLACED BY | J05549 | 290 | J06045 | DISCONTINUED | --- | --- | J06664 | DISCONTINUED | --- | --- |
| J04720 | DISCONTINUED | --- | --- | J06046 | DISCONTINUED | --- | --- | J06665 | DISCONTINUED | --- | --- |
| J04739 | DISCONTINUED | --- | --- | J06058 | DISCONTINUED | --- | --- | J06666 | DISCONTINUED | --- | --- |
| J04761 | DISCONTINUED | --- | --- | J06105 | DISCONTINUED | --- | --- | J06667 | DISCONTINUED | --- | --- |
| J04781 | DISCONTINUED | --- | --- | J06106 | DISCONTINUED | --- | --- | J06668 | DISCONTINUED | --- | --- |
| J04826 | DISCONTINUED | --- | --- | J06117 | DISCONTINUED | --- | --- | J06669 | DISCONTINUED | --- | --- |
| J04833 | DISCONTINUED | --- | --- | J06119 | DISCONTINUED | --- | --- | J06670 | DISCONTINUED | --- | --- |
| J04865 | DISCONTINUED | --- | --- | J06182 | DISCONTINUED | --- | --- | J06671 | DISCONTINUED | --- | --- |
| J04891 | DISCONTINUED | --- | --- | J06208 | DISCONTINUED | --- | --- | J06672 | DISCONTINUED | --- | --- |
| J04896 | DISCONTINUED | --- | --- | J06238 | DISCONTINUED | --- | --- | J06673 | DISCONTINUED | --- | --- |
| J04903 | DISCONTINUED | --- | --- | J06251 | DISCONTINUED | --- | --- | J06674 | DISCONTINUED | --- | --- |
| J04932 | DISCONTINUED | --- | --- | J06295 | DISCONTINUED | --- | --- | J06675 | DISCONTINUED | --- | --- |
| J04940 | DISCONTINUED | --- | --- | J06383 | DISCONTINUED | --- | --- | J06676 | DISCONTINUED | --- | --- |
| J04942 | REPLACED BY | 77-4506 | 465 | J06429 | DISCONTINUED | --- | --- | J06677 | DISCONTINUED | --- | --- |
| J04944 | REPLACED BY | 76-4319 | 466 | J06430 | DISCONTINUED | --- | --- | J06678 | DISCONTINUED | --- | --- |
| J04967 | DISCONTINUED | --- | --- | J06445 | DISCONTINUED | --- | --- | J06679 | DISCONTINUED | --- | --- |
| J05085 | DISCONTINUED | --- | --- | J06453 | DISCONTINUED | --- | --- | J06680 | DISCONTINUED | --- | --- |
| J05103 | DISCONTINUED | --- | --- | J06460 | DISCONTINUED | --- | --- | J06681 | DISCONTINUED | --- | --- |
| J05128 | DISCONTINUED | --- | --- | J06468 | DISCONTINUED | --- | --- | J06682 | DISCONTINUED | --- | --- |
| J05171 | REPLACED BY | 77-4499 | 476 | J06473 | DISCONTINUED | --- | --- | J06683 | DISCONTINUED | --- | --- |
| J05190 | DISCONTINUED | --- | --- | J06535 | DISCONTINUED | --- | --- | J06684 | DISCONTINUED | --- | --- |
| J05192 | DISCONTINUED | --- | --- | J06560 | DISCONTINUED | --- | --- | J06685 | DISCONTINUED | --- | --- |
| J05194 | DISCONTINUED | --- | --- | J06568 | DISCONTINUED | --- | --- | J06686 | DISCONTINUED | --- | --- |
| J05210 | DISCONTINUED | --- | --- | J06570 | DISCONTINUED | --- | --- | J06687 | DISCONTINUED | --- | --- |
| J05212 | DISCONTINUED | --- | --- | J06572 | DISCONTINUED | --- | --- | J06688 | DISCONTINUED | --- | --- |
| J05227 | DISCONTINUED | --- | --- | J06582 | DISCONTINUED | --- | --- | J06689 | DISCONTINUED | --- | --- |
| J05235 | DISCONTINUED | --- | --- | J06583 | DISCONTINUED | --- | --- | J06690 | DISCONTINUED | --- | --- |
| J05244 | DISCONTINUED | --- | --- | J06584 | DISCONTINUED | --- | --- | J06691 | DISCONTINUED | --- | --- |
| J05289 | DISCONTINUED | --- | --- | J06585 | DISCONTINUED | --- | --- | J06692 | DISCONTINUED | --- | --- |
| J05393 | DISCONTINUED | --- | --- | J06586 | DISCONTINUED | --- | --- | J06693 | DISCONTINUED | --- | --- |
| J05425 | DISCONTINUED | --- | --- | J06587 | DISCONTINUED | --- | --- | J06698 | DISCONTINUED | --- | --- |
| J05439 | DISCONTINUED | --- | --- | J06588 | DISCONTINUED | --- | --- | J06700 | DISCONTINUED | --- | --- |
| J05461 | DISCONTINUED | --- | --- | J06589 | DISCONTINUED | --- | --- | J06703 | DISCONTINUED | --- | --- |
| J05524 | DISCONTINUED | --- | --- | J06590 | DISCONTINUED | --- | --- | J06704 | DISCONTINUED | --- | --- |
| J05536 | DISCONTINUED | --- | --- | J06591 | DISCONTINUED | --- | --- | J06715 | DISCONTINUED | --- | --- |
| J05543 | DISCONTINUED | --- | --- | J06592 | DISCONTINUED | --- | --- | J06716 | DISCONTINUED | --- | --- |
| J05565 | DISCONTINUED | --- | --- | J06593 | DISCONTINUED | --- | --- | J06718 | DISCONTINUED | --- | --- |
| J05649 | DISCONTINUED | --- | --- | J06594 | DISCONTINUED | --- | --- | J06719 | DISCONTINUED | --- | --- |
| J05650 | DISCONTINUED | --- | --- | J06595 | DISCONTINUED | --- | --- | LSC-1 | DISCONTINUED | --- | --- |
| J05658 | DISCONTINUED | --- | --- | J06596 | DISCONTINUED | --- | --- | LSC-2 | DISCONTINUED | --- | --- |
| J05659 | DISCONTINUED | --- | --- | J06597 | DISCONTINUED | --- | --- | LSC-3 | DISCONTINUED | --- | --- |
| J05660 | DISCONTINUED | --- | --- | J06598 | DISCONTINUED | --- | --- | LSC-4 | DISCONTINUED | --- | --- |
| J05662 | DISCONTINUED | --- | --- | J06599 | DISCONTINUED | --- | --- | PMC-200 | DISCONTINUED | --- | --- |
| J05667 | DISCONTINUED | --- | --- | J06601 | DISCONTINUED | --- | --- | RK-100CW | DISCONTINUED | --- | --- |
| J05688 | DISCONTINUED | --- | --- | J06606 | DISCONTINUED | --- | --- | SC-3142 | REPLACED BY | 99-8635 | 81 |
| J05690 | DISCONTINUED | --- | --- | J06607 | DISCONTINUED | --- | --- | SC-3329 | DISCONTINUED | --- | --- |
| J05692 | DISCONTINUED | --- | --- | J06608 | DISCONTINUED | --- | --- | SC-3355 | DISCONTINUED | --- | --- |
| J05693 | DISCONTINUED | --- | --- | J06609 | DISCONTINUED | --- | --- | SC-3357 | DISCONTINUED | --- | --- |
| J05712 | DISCONTINUED | --- | --- | J06610 | DISCONTINUED | --- | --- | WB-9 | DISCONTINUED | --- | --- |
| J05721 | DISCONTINUED | --- | --- | J06611 | DISCONTINUED | --- | --- | WRG-100 | DISCONTINUED | --- | --- |
| J05723 | DISCONTINUED | --- | --- | J06612 | DISCONTINUED | --- | --- | WRG-101 | DISCONTINUED | --- | --- |
| J05725 | DISCONTINUED | --- | --- | J06613 | DISCONTINUED | --- | --- | WRG-103 | DISCONTINUED | --- | --- |
| J05726 | DISCONTINUED | --- | --- | J06614 | DISCONTINUED | --- | --- | WRG-303 | DISCONTINUED | --- | --- |
| J05729 | DISCONTINUED | --- | --- | J06615 | DISCONTINUED | --- | --- | WRG-700 | DISCONTINUED | --- | --- |
| J05730 | DISCONTINUED | --- | --- | J06617 | DISCONTINUED | --- | --- | WRG-701 | DISCONTINUED | --- | --- |
| J05731 | DISCONTINUED | --- | --- | J06618 | DISCONTINUED | --- | --- | | | | |
| J05733 | DISCONTINUED | --- | --- | J06619 | DISCONTINUED | --- | --- | | | | |
| J05734 | DISCONTINUED | --- | --- | J06620 | DISCONTINUED | --- | --- | | | | |
| J05735 | DISCONTINUED | --- | --- | J06621 | DISCONTINUED | --- | --- | | | | |